

NT-series C200H Host Interface Unit Direct Connection

Operation Manual

Produced December 1993

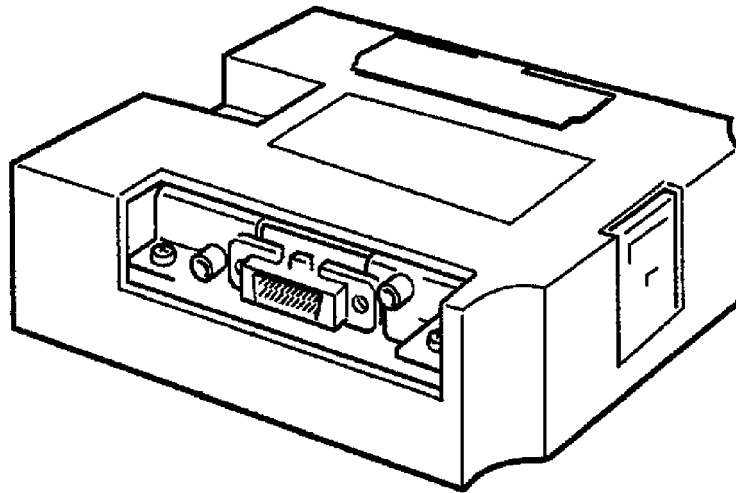

Notice:

OMRON products are manufactured for use according to proper procedures by a qualified operator and only for the purposes described in this manual.

The following conventions are used to indicate and classify precautions in this manual. Always heed the information provided with them. Failure to heed precautions can result in injury to people or damage to the product.

DANGER! Indicates information that, if not heeded, is likely to result in loss of life or serious injury.

WARNING Indicates information that, if not heeded, could possibly result in loss of life or serious injury.

Caution Indicates information that, if not heeded, could result in relative serious or minor injury, damage to the product, or faulty operation.

OMRON Product References

All OMRON products are capitalized in this manual. The word "Unit" is also capitalized when it refers to an OMRON product, regardless of whether or not it appears in the proper name of the product.

The abbreviation "Ch," which appears in some displays and on some OMRON products, often means "word" and is abbreviated "Wd" in documentation in this sense.

The abbreviation "PC" means Programmable Controller and is not used as an abbreviation for anything else.

Visual Aids

The following headings appear in the left column of the manual to help you locate different types of information.

Note Indicates information of particular interest for efficient and convenient operation of the product.

1, 2, 3... 1. Indicates lists of one sort or another, such as procedures, checklists, etc.

© OMRON, 1993

All rights reserved. No part of this publication may be reproduced, stored in a retrieval system, or transmitted, in any form, or by any means, mechanical, electronic, photocopying, recording, or otherwise, without the prior written permission of OMRON.

No patent liability is assumed with respect to the use of the information contained herein. Moreover, because OMRON is constantly striving to improve its high-quality products, the information contained in this manual is subject to change without notice. Every precaution has been taken in the preparation of this manual. Nevertheless, OMRON assumes no responsibility for errors or omissions. Neither is any liability assumed for damages resulting from the use of the information contained in this publication.

TABLE OF CONTENTS

SECTION 1

C200H Host Interface Unit	1
1-1 Getting Starting	2
1-2 Programmable Terminal	3
1-3 C200H Host Interface Unit	5
1-4 System Configuration	8
1-5 Before Operating	9

SECTION 2

Installation and Settings	11
2-1 Components and Settings	12
2-2 Installing the C200H Host Interface	12
2-3 Connection to an OMRON PC	15
2-4 Power ON and OFF	18

SECTION 3

Direct Connection Operation	19
3-1 The Direct Connection Function	20
3-2 Display Element Control and Notification	22
3-3 PT Status Control and Notification	23
3-4 PT Internal Processing Flow	26
3-5 Checking the C200H Host Interface Settings	27

SECTION 4

PT Operation	29
4-1 Using the PT	30
4-2 Switching Displayed Screens	35
4-3 Changing Displayed Numerals or Character Strings	36
4-4 Editing Displayed Numerals or Character Strings	39
4-5 Changing Allocated Word Contents in Indirect Connection	42
4-6 Upgrading Bar Graphs	45
4-7 Controlling the PT Status	46
4-8 Turning Lamps and Touch Switches On and Off	49
4-9 Determining the Screen Displayed on the PT	50
4-10 Determining a Number Input to the PT	52
4-11 Determining PT Operating Status	55
4-12 Determining Touch Switch Status	57

SECTION 5

Data Conversion	61
5-1 Summary of Data Conversion	62
5-2 Data Conversion	62
5-3 Changing the Allocated Bits and Words for Data Conversion	64
5-4 Modifying Programs for Conversion	67

SECTION 6

Troubleshooting	73
6-1 Errors Occurring when the Power is Turned ON	74
6-2 Errors Occurring During Operation	74
6-3 Communication Errors	75

Appendices

A PC Memory Map	77
B Product Information	79

Revision History	81
-------------------------------	-----------

About this Manual:

This manual describes the installation and operation of the NT-series C200H Host Interface Unit Direct Connection and includes the sections described below.

Please read this manual carefully and be sure you understand the information provided before attempting to install and operate the NT-series C200H Host Interface Unit Direct Connection.

Section 1 describes the role and operation of the C200H Host Interface Unit, and its relationship to the PT features and the new Direct Connection function.

Section 2 describes how to connect the C200H Host Interface to the PT and the PT to the PC.

Section 3 describes the basic operation of the new Direct Connection function. Please read this section carefully before using your PT. The Direct Connection function is extremely useful when a PT is used.

Section 4 describes the actual operation of the PT using Direct Connection. Only the allocated bits and words are described related to the settings with the Support Tool.

Section 5 describes how to convert existing screen data for use with Direct Connection and how to convert a PC program written for Direct Connection OFF for use with Direct Connection OMRON.

Section 6 describes the procedures to follow if the PT does not operate correctly.

The **Appendices** provide a PC memory map table and lists on product information.

<p>WARNING Failure to read and understand the information provided in this manual may result in personal injury or death, damage to the product, or product failure. Please read each section in its entirety and be sure you understand the information provided in the section and related sections before attempting any of the procedures or operations given.</p>

SECTION 1

C200H Host Interface Unit

This section describes the role and operation of the C200H Host Interface Unit, and its relationship to the PT features and the new Direct Connection function.

1-1	Getting Starting	2
1-2	Programmable Terminal	3
1-2-1	Role and Operation	3
1-2-2	Displays	5
1-3	C200H Host Interface Unit	5
1-3-1	Operation	5
1-3-2	Direct Connection Function	6
1-4	System Configuration	8
1-5	Before Operating	9

1-1 Getting Starting

To ensure that the C200H Host Interface Unit works correctly, carefully observe the following when positioning and handling it.

Location

Do not install the C200H Host Interface Unit in a location subject to the following conditions:

- Dust, chemicals, or steam
- Severe temperature fluctuations
- High humidity and condensation
- Direct sunlight
- Strong electrical or magnetic fields
- Poor ventilation
- Severe vibration

Handling

Do not:

- Subject the Unit to strong shocks or vibrations
- Position the Unit's PCB downward
- Touch the Unit's PCB
- Put heavy objects on the Unit
- Supply a voltage different from the specified voltage

System Configuration

The equipment and parts required to configure the system to use the Direct Connection function are shown below.

Programmable Terminal		Screen-data Memory Board/ Screen Memory	Host I/F Unit	System ROM	Support tools
NT20M	Monochrome LCD: NT20M-DT121-V2 Touch-panel Model	Screen Memory SRAM/32 KB: RAM22-15 SRAM/128 KB: RAM13-10 EPROM/64 KB: ROM-KD-B EPROM/128 KB: ROM-13-12B EEPROM/32 KB: EER22-20	C200H Host Inter- face Unit NT600M-LB122	NT20M- SMR32-E	NTM Support Tool NT20M-ZASAT-EV4: 3.5-inch (2DD) and 5.25-inch (2HD) disks
	Backlight replace- able: NT20M-DT131 Touch-panel Model				
NT2000M	NT2000M-DT131 Touch-panel Model Color of casing: light gray				
	NT2000M-DT131B Touch-panel Model Color of casing: black				
NT600M	Monochrome LCD: NT600M-DT122 Touch-panel Model	Screen-data Memory Board IC socket type: NT600M-MP251 64-kbyte SRAM: NT600M-MR641 128-kbyte SRAM: NT600M-MR151 256-kbyte SRAM: NT600M-MR251 Screen Memory The screen memory chip must be inserted in the IC socket. Screen data is written with a PROM writer. The EEPROM can be mounted to the PT for data trans- mission. 64-kbyte EPROM: ROM-KD-B 128-kbyte EPROM: ROM 13-12B 256-kbyte EPROM: ROM 23-15B 32-kbyte EE- PROM: EER22-20	C200H Host Inter- face Unit NT600M-LB122	NT600M- SMR32-E	
	EL display: NT600M-DT211 Touch-panel Model				

1-2 Programmable Terminal

The OMRON Programmable Terminal (PT) displays the status and other information about the FA-applied factory. The PT is briefly described below.

1-2-1 Role and Operation

The Programmable Terminal (PT) is a FA factory terminal device which communicates with Programmable Controllers (PCs) and displays the operating status of machines and other equipment, work instructions, and operations of the PT.

Production Line Status Monitoring

The PT displays real-time information about the system and equipment operating status and manufactured quantity.

Production Control (3)		Date: 27 Jan 93 Time: 14:15:32	
Product	NT20M	NT600M	NT10S
Today's target	560 units	441 units	352 units
Current production	305 units	275 units	213 units
% achieved	54.4 %	60.0 %	60.5 %
Defects	2 units	8 units	1 unit
Repairs	7 units	15 units	5 units

Messages

The PT warns of system or equipment errors with a display and buzzer, and prompts the appropriate remedial action.

Alarm

Assembly line B - Positioning pin

is defective. Line stopped.

Check these points:

1. Pin L3 missing?
2. Position of dog M2.
3. Attachment of photosensor P5.

Panel Switch Functions (Operation from the PT)

Setting touch switches on the PT allows workers to use the PT as an operating panel. Production targets and other numeric data input to the PT can be transmitted to the PC.

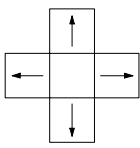
Electroplating Control						
Transport		Electrolyte head	Rinsing head	Rust-proofing head		
		Clamp	UP	UP	UP	
		Unclamp	DOWN	DOWN	DOWN	
Halt	Advance Retract	Electrolyte	Rinse	Rust-proofing fluid	Stop buzzer	Alarm

1-2-2 Displays

The PT can display the following items to provide the operations mentioned previously. Each of these items is called a “display element.”

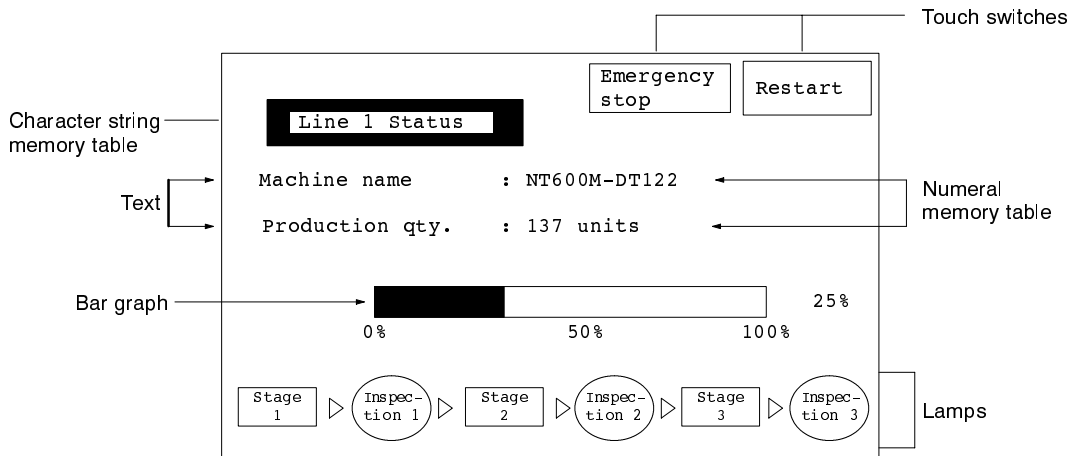

Text

Characters which remain unchanged can be written directly as text.

Character String Memory Tables

Character strings stored in the character-string memory table are displayed. The display can be changed by changing the data stored in the character-string memory table.

Numeral Memory Tables

Numbers stored in the numeral memory table are displayed. The display can be changed by changing the data stored in the numeral memory table. The C200H Host Interface Unit Direct Connection also allows the display of hexadecimal values.

Lamps

Lamps are square or round frames which indicate the operating status. They are controlled by the PC. They can be lit (highlighted) or flashed (intermittent normal and highlighted display).

Touch Switches

Touch switches can be set anywhere on the screen. Touching the screen at a touch switch location can switch the display (stand-alone function or display-switch function) or notify the PC (notification function). The touch switches can be lit or flashed by the PC in the same way as the lamps.

Bar Graphs

The bar graph displays a comparison with a value stored in the memory table. A percentage value can be displayed simultaneously.

1-3 C200H Host Interface Unit

The C200H Host Interface Unit provides communication between the PT and PC. The following sections describe the operation of the C200H Host Interface Unit and the Direct Connection function.

Refer to *Section 3 Direct Connection Operation* and *Section 4 PT Operation* for details on the Direct Connection function.

1-3-1 Operation

Many communication interfaces are available to provide communication between the PT and PC for different system configurations. The C200H Host Interface Unit is just one of the communication interfaces which can be mounted on the PT. It can be connected to the CPU of a PC.

The C200H Host Interface Unit operates as an intermediary between the PT and PC. It reads information to be displayed on the PT from the PC memory area and writes it to the PT memory table, and writes information to the PC memory area with the PT touch switches.

The C200H Host Interface Unit reads instructions to switch screens from the PC memory area and controls the PT. It reads the status of the PT and writes it to the PC memory area.

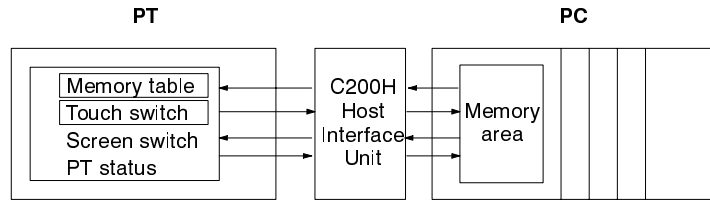

1-3-2 Direct Connection Function

The new Direct Connection function has been added to the C200H Host Interface Unit to enable the reading and writing of PC bit and word data.

The Direct Connection function is described below.

- The PT is able to directly refer to PC bit and word data so that a PT can be connected to a PC without changing the PC program currently running the production line.
- The bits and words referring to operating status and work instruction information and those storing input data can be freely allocated to almost any part of the PC memory. Bits and words in the PC can be referenced from any memory table.
- The area to control and notify the PT status, including display screens, backlighting on a flash control, alarms and buzzers, can be freely allocated to any part of the PC memory.

Setting

The Direct Connection function is set using the NT-series Support Tool, which is the name of the software used to create and maintain the display data for the PT displays, memory table data, and mark data. Refer to the manual listed below for information on the Support Tool and how it is used, as well as for the system configuration:

NT20M/NT2000M/NT600M Support Tool Operation Manual (V004)

Direct Connection is Not Selected

When Direction Connection is not selected only the following Units can be used with the C200H Host Interface Unit. Use the NT600M-LB121 Interface Unit in combination with the NT600M-SMR02-E System ROM or the NT20M-SMR02-E System ROM.

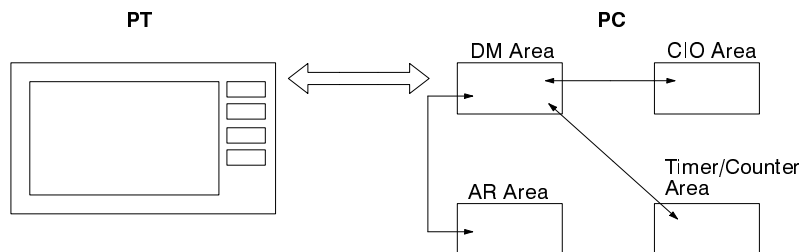

Direct Connection is Set

The C200H Host Interface Unit Direct Connection protocol is used. Direct Connection allows direct reading and writing of most bits and words of the PC memory and allows automatic changing of the display. This new communication format reduces the load on the PC and increases the efficiency of program development.

Refer to *Section 3 Direct Connection Operation* and *Section 4 PT Operation* for details on the Direct Connection function.

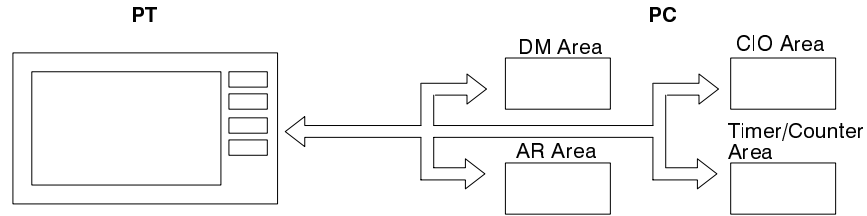

Direct Connection Examples

Examples are presented below of PT and PC operation when the Direct Connection function is set.

Example 1

The status of a PC bit can be directly displayed as a PT lamp without using a PC program.

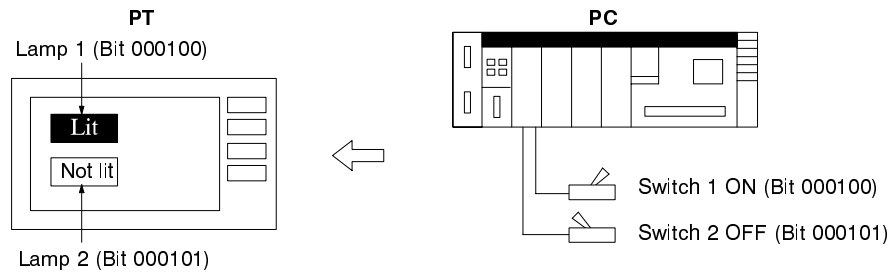

Example 2

The displayed word can be freely selected for each memory table. The display as a heraldically value makes it easy to monitor word contents.

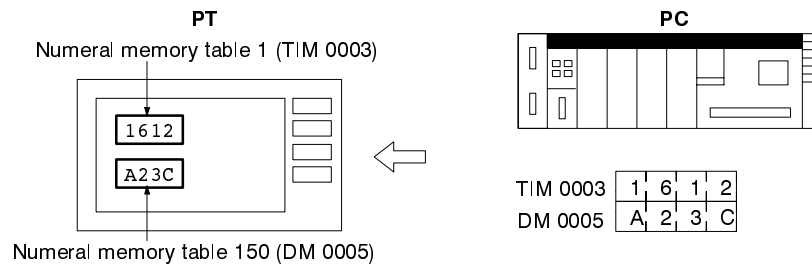

1-4 System Configuration

This section shows the basic configuration of a system using a C200H Host Interface Unit. Refer to the individual equipment manuals for information on the equipment used in the system.

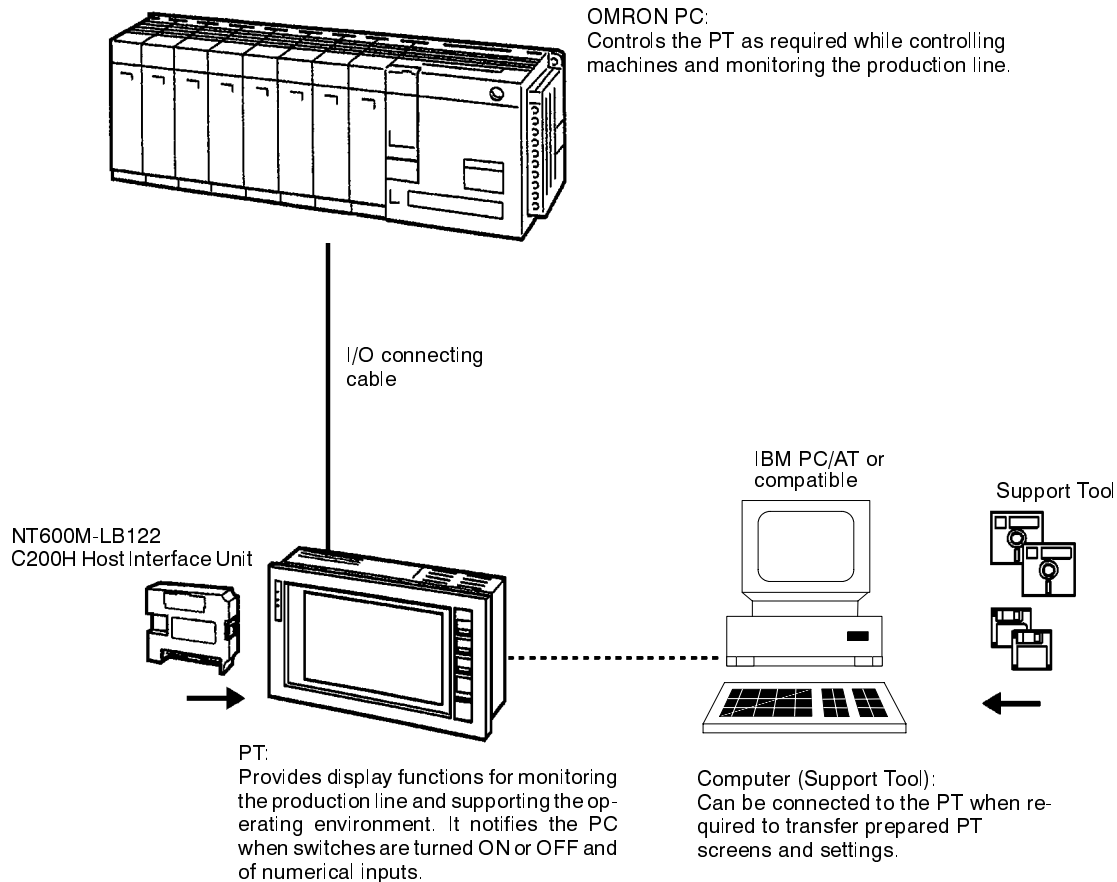

System Equipment and Software

OMRON PC	C200H, C20H, C28H, C40H, and C60H PCs can be directly connected to the PT via an I/O connecting cable.
Programmable Terminals	NT20M, NT2000M, and NT600M.
Computer	IBM PC/AT or compatible.
Support Tool	NT20M/NT2000M/NT600M Support Tool Version 4.□.

Connections

Use an I/O connecting cable to connect the PT to the PC.

Refer to *Section 2 Installation and Settings* for details on connecting the PT to the PC.

1-5 Before Operating

Follow the procedure indicated below before operating a PT with C200H Host Interface Unit installed.

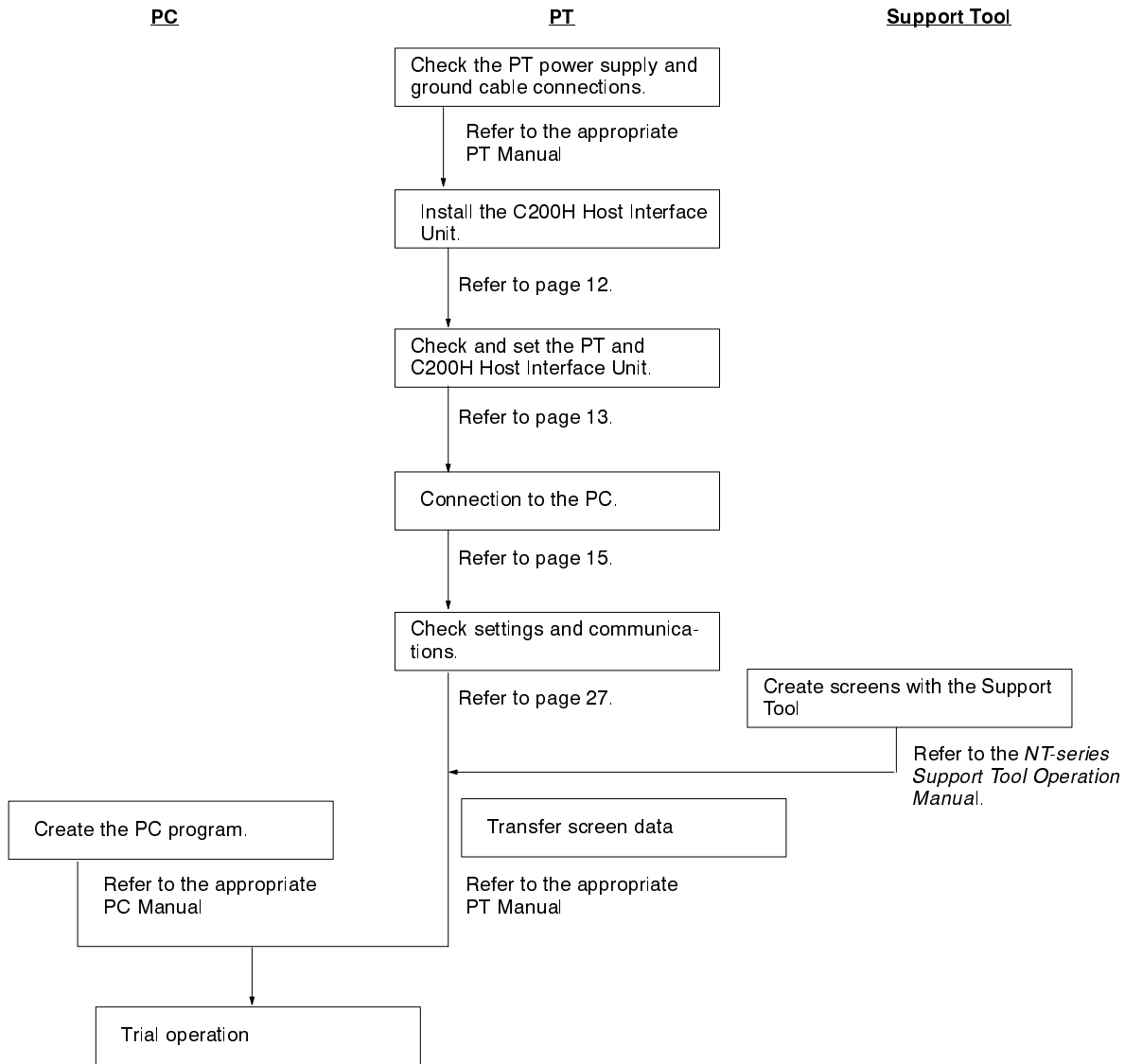

Reference Manuals

The NT20M/NT2000M Series and NT600M Series are covered in the seven manuals described below.

Name of Manual	Contents	Manual No.
NT20M/NT2000M Operation Manual	This manual provides specifications, functions, and operating instructions for the NT20M and NT2000M Programmable Terminals.	V001
NT600M Operation Manual	This manual provides specifications, functions, and operating instructions for NT600M Programmable Terminals.	V002
NT-series Host Interface Unit Operation Manual	This manual covers the commands, controls, and communications specifications for operating the NT20M and the NT600M. Refer to this manual when programming host computer communications.	V003
NT20M/NT600M Support Tool Operation Manual	This manual covers methods for creating screens, including screen data preparation, switches, lights, and alarms.	V004
NT-series Host Interface Unit Direct Connection Operation Manual	This manual covers the Direct Connection feature which has been added to the Host Interface Unit.	V015
NT-series RS-232C/RS-422 Interface Unit Operation Manual	This manual covers the commands, controls, and communications specifications for operating the NT20M and the NT600M with the RS-232C/RS-422 Interface Unit. Refer to this manual when programming host computer communications.	V016
NT-series C200H Host Interface Unit Operation Manual	This manual covers the commands, controls, and communications specifications for operating the NT20M and the NT600M. Refer to this manual when programming C200H or C□□H communications.	V018

SECTION 2

Installation and Settings

This section describes how to connect the C200H Host Interface to the PT and the PT to the PC.

2-1	Components and Settings	12
2-1-1	Description and Function of Components	12
2-2	Installing the C200H Host Interface	12
2-2-1	Installation	12
2-2-2	Setting the C200H Host Interface Unit Switches	13
2-2-3	Limitations on PC Area	14
2-3	Connection to an OMRON PC	15
2-3-1	Compatible PCs	15
2-3-2	Connection	15
2-4	Power ON and OFF	18

2-1 Components and Settings

The parts of the C200H Host Interface and how to set the operating environment are described below.

2-1-1 Description and Function of Components

The names and functions of the C200H Host Interface parts are shown in the diagram below.

NT600M-LB122 C200H Host Interface

C200H Host Interface front face

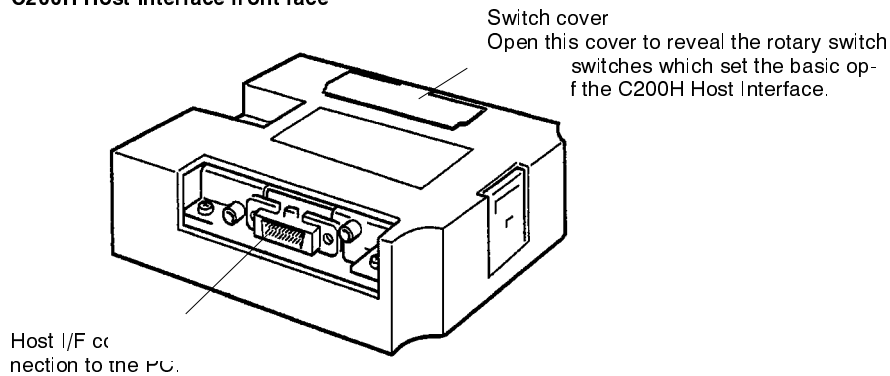

C200H Host Interface rear face

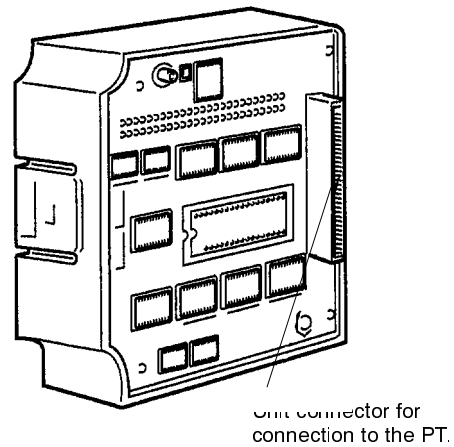

2-2 Installing the C200H Host Interface

How to install the C200H Host Interface in the PT.

2-2-1 Installation

Turn the cut-out in the C200H Host Interface to the left and push the Unit in until a “click” is heard.

In difficult-to-connect situations move the Unit when connecting the C200H Host Interface.

Installation in the NT20M

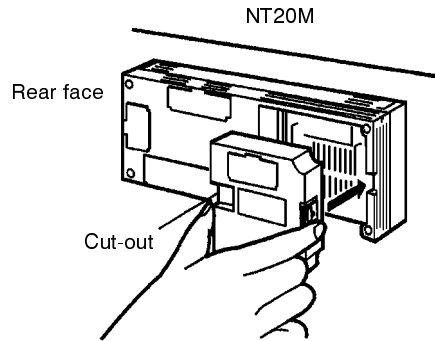

Installation in the NT600M

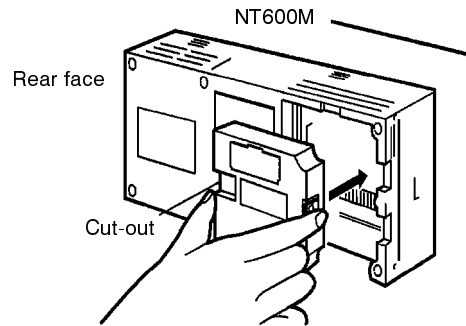

Removal from the PT

Hold the Unit by the indentations at each side, press inwards and pull out the Unit.

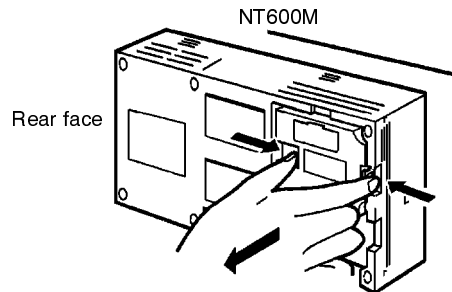

Note Turn off the PT power supply when installing or removing the Unit.

2-2-2 Setting the C200H Host Interface Unit Switches

Before mounting the PT, the operating environments of the PT must be set with the DIP switch (SW1) and rotary switch (SW3) on the C200H Host Interface Unit.

DIP Switch Settings

The DIP switch (SW1) settings are described below.



Factory setting

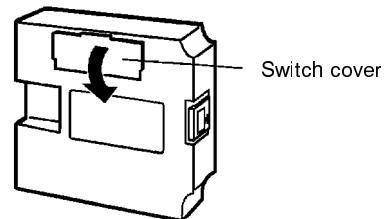

The DIP switches are under the switch cover on the rear of the C200H Host Interface Unit.

SW1-1 Initializes the memory table allocating the words.

Setting	Meaning	Description
ON	PT	Set to initial values preset by the Support Tool.
OFF	PC	The contents of the words allocated in the PC memory are used as the memory table initial values.

SW1-2 to 1-8 Reserved for system use. Be sure to turn these pins OFF.

SW2-1 to SW2-4 Not used.

Note Turn off the power supply before setting the DIP switches.

Rotary Switch Settings The rotary switch (SW3) on the C200H Host Interface Unit is used to set a unit number for the C200H Host Interface Unit. The C200H Host Interface Unit is treated the same as a C200H Special I/O Unit. Therefore, the unit number allocated to the C200H Host Interface Unit must be unique and not identical with the unit number of any Special I/O Unit.

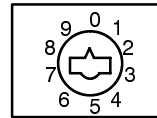

Set to 0 before shipping

When the unit number has been set, the Special I/O Unit will be allocated the corresponding words in C200H memory, as shown in the following table. The words which are allocated to the C200H Host Interface Unit, however, are not used because C200H Host Interface Unit processing is handled in the area allocated by the Support Tool. The words allocated to the C200H Host Interface Unit as a Special I/O Unit can therefore be used as work bits/words.

Unit no.	Word no.
0	100 to 109
1	110 to 119
2	120 to 129
3	130 to 139
4	140 to 149
5	150 to 159
6	160 to 169
7	170 to 179
8 (see note 1)	180 to 189
9 (see note 1)	190 to 199

- Note**
1. Do not set the unit number of the C□□H to 8 or 9, otherwise a Special Unit Error will result.
 2. If the C200H Host Interface Unit is connected to the C□□H, no Expansion I/O Unit can be connected to the C□□H. Therefore, any of the above unit numbers can be designated without worrying about unit number duplication.

2-2-3 Limitations on PC Area

Special Relay Area (SR 236 to 255) SR 25415 is used as a Special Unit Error Flag.

Auxiliary Relay Area (AR 00 to AR 27) AR 07 is used as an error log bit when a C200H-CPU31-E is used. AR 18 to AR 21 are used as clock bits when a C200H-CPU11-E, C200H-CPU21-E, C200H-CPU23-E, or C200H-CPU31-E is used. Other words are used as the HR area.

**Data Memory Area
(DM 0000 to DM 1999)**

The area from DM 0969 to DM 0999 is for the error log when a C200H-CPU31-E is used. The area from DM1000 to DM 1999 is used exclusively for unit setting and this area can be set as read only. An area not allocated with the DM words can be used for other purposes.

Unit no.	DM words
0	1000 to 1099
1	1100 to 1199
2	1200 to 1299
3	1300 to 1399
4	1400 to 1499
5	1500 to 1599
6	1600 to 1699
7	1700 to 1799
8	1800 to 1899
9	1900 to 1999

2-3 Connection to an OMRON PC

Connect the PT fitted with the C200H Host Interface Unit to the OMRON PC with an I/O connecting cable.

2-3-1 Compatible PCs

Check the PC model number and series before making the connections.

The compatible PCs are listed in the table below.

CPU	PC
C20H, C28H, C40H, and C60H	C□□H
C200H-CPU01-E C200H-CPU03-E C200H-CPU11-E C200H-CPU21-E C200H-CPU23-E C200H-CPU31-E	C200H

2-3-2 Connection

The following describes how to connect the C200H Host Interface Unit to the PC. The conditions required for connecting the C200H Host Interface Unit to the C200H vary from those required for connecting the C200H Host Interface Unit to the C□□H.

Note Turn off the PT and PC power supplies before inserting or removing connectors.

I/O Connecting Cable

Select the I/O connecting cable from the following.

PC	Model	Cable length
C200H	C200H-CN311	30 cm
	NT20M-CNP711	70 cm
	C200H-CN711	
	NT20M-CNP221	2 m
	C200H-CN221	
	NT20M-CNP521	5 m
C□□H	C20H-CN312	30 cm
	NT20M-CNP712	70 cm
	C20H-CN712	
	NT20M-CNP222	2 m
	C20H-CN222	

- Note**
1. The connector on the C200H Host Interface Unit side of the NT20M-CNP□□□ is miniaturized.
 2. The total length of the I/O connecting cables between the C200H Host Interface Unit and the C200H must be 12 m maximum and the cables between the C200H Host Interface Unit and the C□□H must be 6 m maximum.
 3. Do not impose a pulling force exceeding 5 kg on any I/O connecting cable.
 4. If an I/O connecting cable is extended through a hole, the diameter of the hole must be 53 mm minimum. By removing the connector cover, the I/O connecting cable can pass through a hole with a diameter of 33 mm, in which case, be sure to replace the cover onto the connector after the I/O connecting cable passes through the hole.

Connection to C200H

The C200H Host Interface Unit can be connected to a single CPU or Expansion I/O Rack via an I/O connecting cable with the following restrictions.

- The C200H Host Interface Unit cannot be connected to the Expansion I/O Rack if the Expansion I/O Rack is connected to another Expansion I/O Rack.
- The C200H Host Interface Unit cannot be connected to a Remote I/O Slave Unit.

- The C200H Host Interface Unit has a single connector. The C200H Host Interface Unit cannot be connected between the CPU and Expansion I/O Rack. The C200H Host Interface Unit must be always connected to the end of the system.

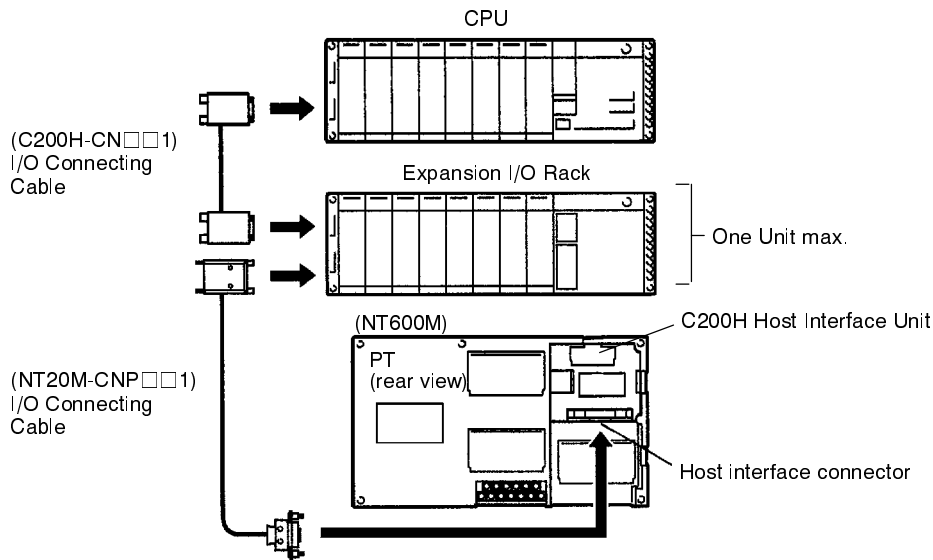

Connection to C□□H

The C200H Host Interface Unit can be connected to a single CPU via an I/O connecting cable with the following restrictions.

- A maximum of two I/O Units can be connected to the CPU. No Expansion I/O Rack can be connected.
- The C□□H I/O Unit cannot be connected after the C200H Host Interface Unit. The C200H Host Interface Unit must be always connected to the end of the system.

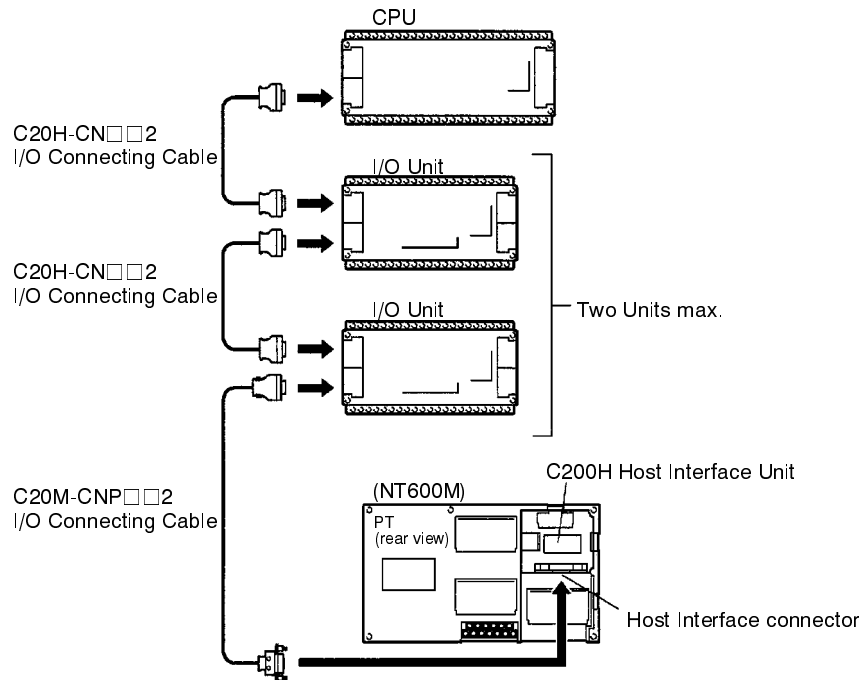

- Note**
1. Install a noise filter with a rated voltage of 24 VDC or equivalent to the power lines of the C□□H as shown in the following diagram.
 2. The distance between the noise filter and the C□□H must be as short as possible, and the noise filter must be separated from high tension lines.

3. Ground the case of the noise filter to the FG terminal.

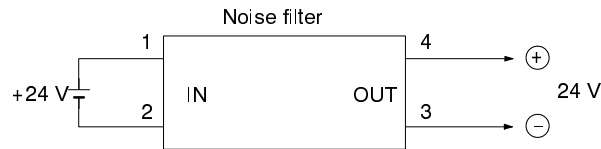

2-4 Power ON and OFF

The C200H Host Interface Unit operates as a C200H Expansion I/O Rack. This section describes how to turn the C200H Host Interface Unit ON and OFF. Be sure to follow the procedures described below, otherwise the whole system may shut down.

Power ON

To turn ON the C200H Host Interface Unit, turn ON the PT first, at which time the PT screen displays “Connecting to Host.” Then turn ON the PC, at which time the system will go into normal operation after “Connecting to Host” is displayed on the PT screen for approximately 1 s.

- Note**
1. When the PC is turned ON first, the CPU of the PC resets the system. If a Programming Console is used in the system, the Programming Console will not operate. However, when the PT is turned ON, the PT screen displays “Connecting to Host” for approximately 1 s and then the system will go into normal operation.
 2. If the I/O connecting cable is disconnected during system operation, PC will have an I/O Bus Error and the operation will be interrupted. If this occurs, connect the I/O connecting cable and reset the system.

Power OFF

To turn OFF the C200H Host Interface Unit, turn OFF the PC and PT simultaneously, in which case the PT will keep the screen as it is until the next time the PT is turned ON.

- Note** If the PT is turned OFF first, the CPU of the PC resets the system. If a Programming Console is used in the system, the Programming Console will not operate.

WARNING Interrupt the system to replace the PT or C200H Host Interface Unit. If only the PT is turned OFF before replacing the PT or C200H Host Interface Unit, however, the system will be interrupted instantly and the machines connected to the system may be damaged or an accident may result.

SECTION 3

Direct Connection Operation

This section describes the basic operation of the new Direct Connection function. Please read this section carefully before using your PT. The Direct Connection function is extremely useful when a PT is used.

3-1	The Direct Connection Function	20
3-2	Display Element Control and Notification	22
3-3	PT Status Control and Notification	23
3-3-1	PT Status Control Area	23
3-3-2	PT Status Notify Area	25
3-4	PT Internal Processing Flow	26
3-5	Checking the C200H Host Interface Settings	27

3-1 The Direct Connection Function

Direct Connection is a new function added to the C200H Host Interface Unit. Its features are described below.

Direct Connection

When a C200H Host Interface Unit is mounted to a PT, the bits and words of the PC memory area can be freely allocated as reference elements required for the display and to store input data. The PT is then able to directly read and write these allocated bits and words to change the display and to control and notify the PT status. This function is called Direct Connection. The bits and words allocated for use by the Direct Connection function are referred to as “allocated” bits and words.

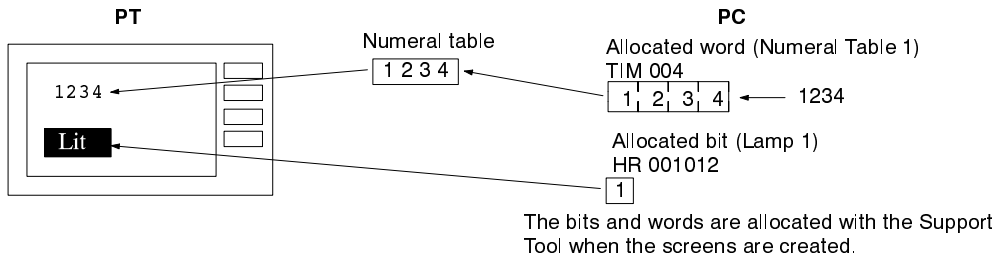

The C200H Host Interface Unit treated as a Special I/O Unit for the PC processes and exchanges data at high speed with the PC.

Direct Connection and Indirect Connection

There is a Direct Connection method and Indirect Connection method to allocate numeral tables for numeral display and character-string memory tables for character-string display. Only the Direct Connection method is used to allocate numeral tables used for bar graphs or numeral settings.

Direct Connection

The Direct Connection method enables the contents of the allocated word to correspond directly to those of the memory table to be displayed.

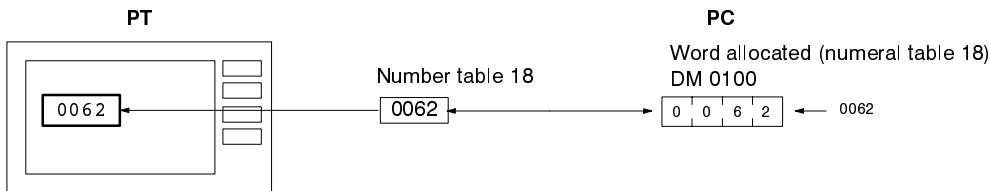

Indirect Connection

Regardless of whether the contents to be displayed are numeral or character-string data, the Indirect Connection method enables the display contents to correspond to the numeral table to be used so that the contents (value) of the numeral table will be regarded as the memory table number in order to display the contents of the memory table number. The memory table number is regarded as a numeral table number in the case of numeral display and a character-string memory table number in the case of character-string display.

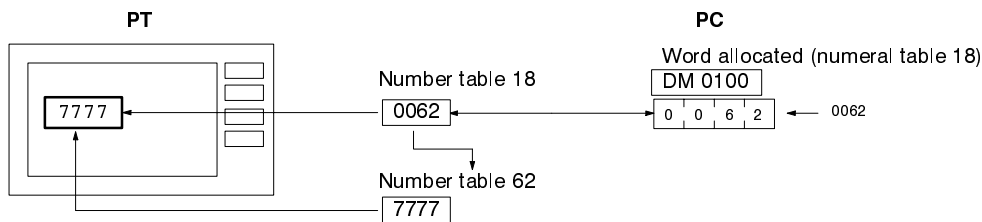

The contents of what is displayed can be changed with ease according to the situation although the connection procedure will be complicated. In the above example, when 1 is added to the contents of numeral table 18 to obtain 63, the contents of numeral table 63 will be displayed. The memory table used for dis-

play can be allocated to the PC's area so that what is displayed will change according to the change in the contents (i.e., the contents of numeral table 62 in the above case) to be displayed.

Refer to 4-5 *Changing Allocated Word Contents in Indirect Connection* for details on changing what is displayed in the Indirect Connection method.

Note The Indirect Connection method requires more time for processing than the Direct Connection method.

Types and Features of Allocated Data

Using Direct Connection the following items can be allocated to bits and words of the PC memory:

- Display elements: numerals, character strings, lamps, touch switches
- PT status: alarm and buzzer outputs, backlight lit or flashing, screen selection, currently displayed screen number, operating status, etc.

These allocated bits and words can be used by the PC to control the PT. The items the PC can control are categorized into two groups, as follows:

- Control and notification of display elements
- Control and notification of PT status

The relationship between the allocated memory and the control operation is shown in the table below.

Element, area	Allocated memory	Function	Control or Notification
Lamp	Bit	Control of display elements	Lights (flashes) when the allocated bit is turned ON (1) and goes out when the bit is turned OFF (0).
Touch switch	Bit	Control of display elements	Lights (flashes) when the allocated bit is turned ON (1) and goes out when the bit is turned OFF (0).
		Display element notification	The allocated bit remains ON (1) while the touch switch is pressed.
Numeral table	Word	Display element control and notification	The contents of the allocated word and numeral table are continuously read and written to ensure that their contents are always identical.
Character-string memory table	Word	Display element control and notification	The contents of the allocated word and character-string memory table are continuously read and written to ensure that their contents are always identical.
PT Status Control Area	Word	PT status control	The allocated word is read to control the next PT status, including screen selection, copying a memory table, buzzer, backlighting.
PT status notification	Word	PT status notification	Notifies the allocated word of a change in PT status, including change of selected screen, numeral input to the memory table, operating status.

- Note**
1. To use the Direct Connection function, words must be allocated for the PT Status Control Area and PT Status Notify Area.
 2. The Indirect Connection method can be used for numeral tables for numeral display and character-string memory tables for character-string display.

Data Allocated in the PC The following bits and words of the PC memory area can be allocated.

Symbol	Area name	Allocate bit	Allocate word	
			Numeral	Character string
DM	Data Memory	OK	OK	OK
I/S (see note 3)	Internal/Special Relay	OK	OK	OK
TIM	Timer	NG	1 word only	NG
CNT	Counter	NG	1 word only	NG
HR	Holding Relay	OK	OK	OK
AR	Auxiliary Relay	OK	OK	OK
LR	Link Relay	OK	OK	OK

The range of each memory area differs according to the PC type. Refer to *Appendix B PC Memory Map* for more details.

Words allocated as memory tables are limited in length as follows:

Numeral table entries: 2 words max.

Character-string memory tables: 20 consecutive words max.

If the PT Status Control Area and PT Status Notify Area are allocated, four words are used for the PT Status Control Area and three words for the PT Status Notify Area.

- Note**
1. Do not allocate words outside the memory area.
 2. The PT cannot determine whether the word allocation area is a write-protected area or not. Be sure to allocate the words to an area that is not write-protected.
 3. The I/S Relay area includes internal, special and CIO memory areas.

3-2 Display Element Control and Notification

The control and notification of display elements using allocated bits and words is described below.

Controlling Display Elements

The PT and PC operate as described below to display element control.

- 1, 2, 3... 1. The PT asks the PC the status of the bits and words allocated to the elements displayed on the screen.
2. The PC responds with bit and word data.
3. The PT changes the display in response to the bit and channel data received.

Example:

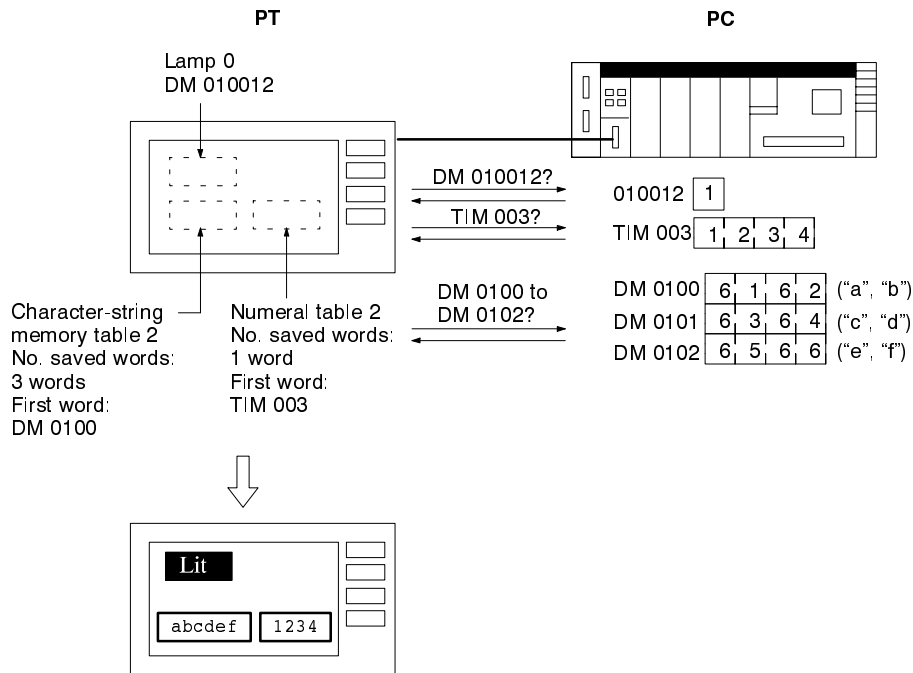

Notification of Display Elements

When the contents of a currently displayed numeral or character-string memory table is changed or a touch switch is pressed, the information is written to the bits and words in the PC memory.

Example:

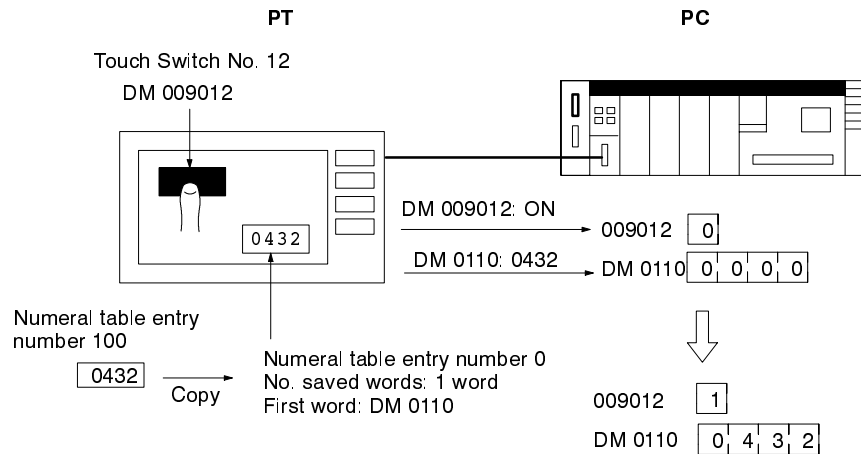

3-3 PT Status Control and Notification

The PT Status Control Area and PT Status Notify Area are described below. Refer to 4-1 Using the PT for details.

3-3-1 PT Status Control Area

The PT Status Control Area is set by choosing Direct or Direct Specify Information under the Expansion Function from the Screen List on the Support Tool. Any data written to this specified area is read by the PT.

The PT Status Control Area is configured as four consecutive words, as shown in the diagram below.

First word (Word n): Set with the Support Tool when the screen is created.

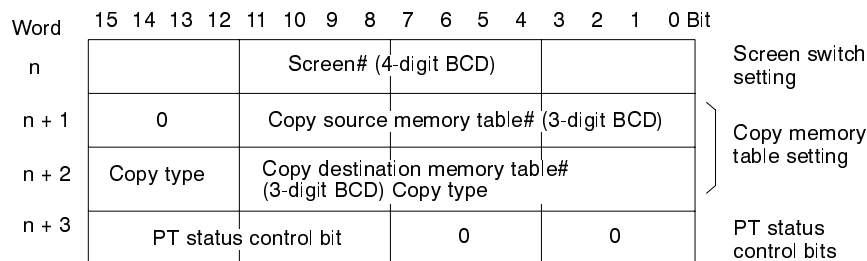

Screen Switch Settings

Specify the screen# to switch the screen displayed on the PT.

Copy Memory Table Settings

Specify to copy the contents of a memory table internally in the PT.
 Set the copy type to match the type of memory table to be copied, as follows:
 0: Character-string memory table
 1: Numeral table

PT Status Control Bits

Set the bits ON or OFF according to the following table to control the backlight, buzzer, etc.

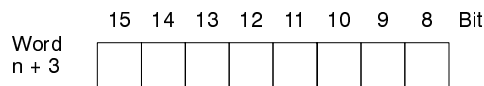

Bit no.	Controlled item	1 (ON)	0 (OFF)
15	Screen display	ON	OFF
14	Alarm output	ON	OFF
13	Continuous buzzer	ON	OFF
12	Intermittent buzzer	ON	OFF
11	Initialize display history	ON	OFF
10	Backlight color	Red	White
8	Backlight mode	Continuous light	Flash

Note Bit 10 (Backlight color) is valid for the NT20M.
 Bit 8 (Backlight mode) is valid for the NT20M.
 Bit 15 (Screen display) when used for an LCD (liquid-crystal display) backlight turns ON if the screen display bit is set to ON and turns OFF if the screen display bit is set to OFF.

Using the PT Status Control Area

When control data is written to the PT Status Control Area, the PT responds as shown in the diagram below.

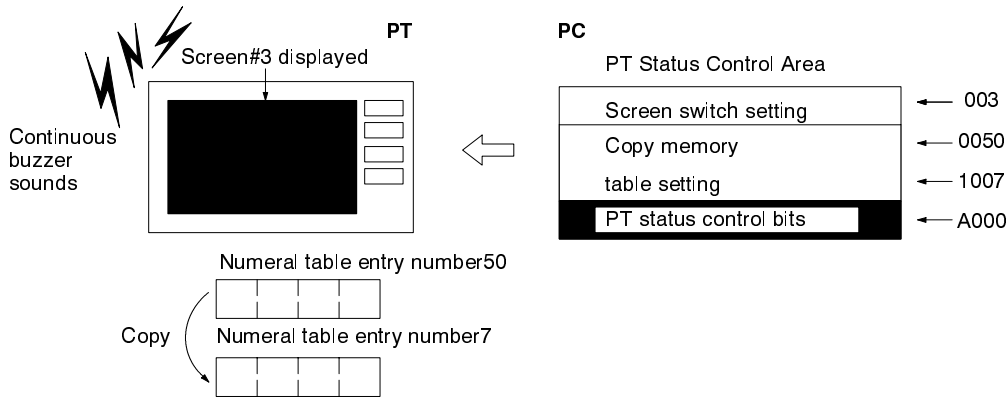

3-3-2 PT Status Notify Area

The PT Status Status Notify Area is set by choosing Direct or Direct Specify Information under the Expansion Function from the Screen List on the Support Tool.

Any changes in PT status are written to the PC PT Status Notify Area.

The PT Status Notify Area is configured as three consecutive words, as shown in the diagram below.

First word (Word n): Set with the Support Tool when the screen is created.

	15	14	13	12	11	10	9	8	7	6	5	4	3	2	1	0	Bit						
Word n	Screen# (4-digit BCD)											Currently displayed screen											
n + 1	0			Numeral table entry number (3-digit BCD)											Content upgrade memory table								
n + 2	PT status											0		0					PT status				

Currently Displayed Screen

The screen number of the screen displayed on the PT is written to this word.

Content Upgrade Memory Table

The number of the numeral table is written to this word when the numeral table contents change due to PT switch operation. The input value appears in the word allocated for the appropriate numeral table. As the number of the numeral table is written, the PT Status Number Setting Flag is simultaneously set ON (1). After the PC is notified, this flag reverts to OFF (0). Checking the status of this flag provides a simple method of checking if a number has been input from the PT.

PT Status

The bits shown in the following table are turned ON or OFF in response to the PT operating status and battery level.

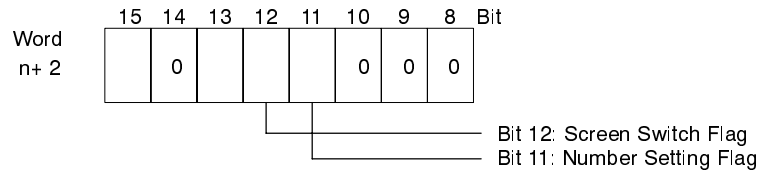

Bit	Notified item	1 (ON)	0 (OFF)
15	PT operating status	Run	Stop
13	Battery	Low	Normal

Using the PT Status Notify Area

The PT Status Notify Area is notified as follows when the PT status changes.

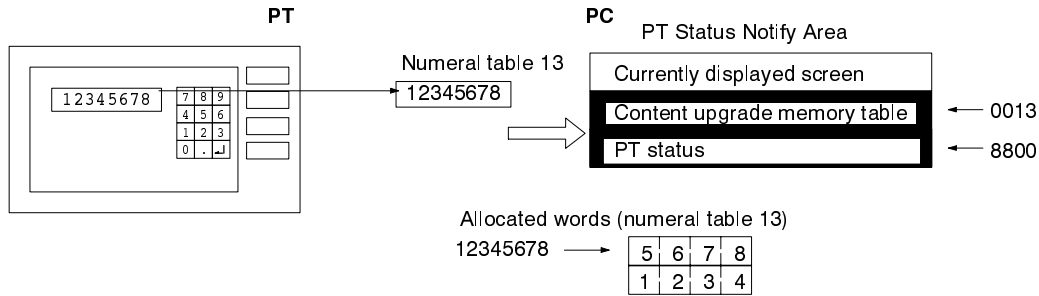

3-4 PT Internal Processing Flow

The processing carried out inside a PT mounted to a C200H Host Interface Unit is described below, which allows high-speed data exchange with PC and high-speed PT control operation.

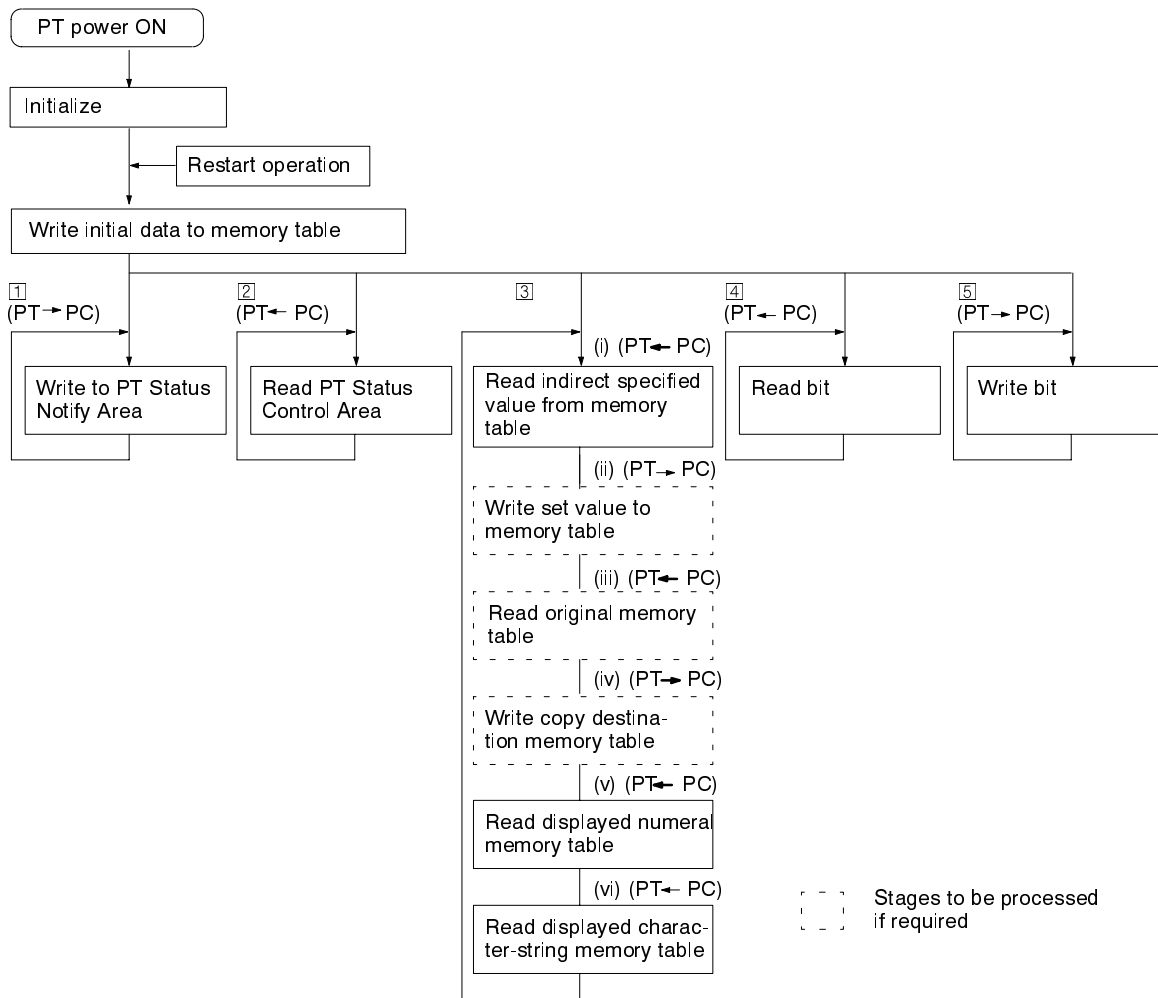

Note Only the data used for the currently displayed screen is exchanged with the PC. Any unused data will not be exchanged even if the status of the data changes. Before copying a memory table, however, the contents of the original memory table are read from the PC and the contents of the destination memory table are written to the PC after the memory table is copied. Therefore the PC's cycle time changes per displayed screen.

Contents of Processing

Initialize	The hardware and communication status are checked.
Write Initial Data to Memory Table	The initial data stored in the PT is written as the memory table initial data to the allocated word in the PC.
Write to PT Status Notify Area (See ① of Flowchart)	The PT Status Notify Area is written to notify the PC of a change in the PT operating status.
Read PT Status Control Area (See ② of Flowchart)	The PC reads and executes the contents of the PT Status Control Area to control the PT.
Read Indirect Specified Value from Memory Table (See ③(i) of Flowchart)	The contents of the word used by the numeral table in the Indirect Connection method are read from the PC to change the display.
Write Set Value to Memory Table (See ③(ii) of Flowchart)	If there is any input value to the numeral table using the numeral setting function, the contents of the word allocated to the PC is replaced with the input value.
Read Original Memory Table (See ③(iii) of Flowchart)	Before copying a memory table, the contents of the word allocated to the original memory table are read from the PC.
Write Copy Destination Memory Table (See ③(iv) of Flowchart)	After a memory table is copied, the contents of the word allocated to the copy destination memory table are replaced.
Read Displayed Numeral Table (See ③(v) of Flowchart)	The contents of the word used by the numeral table for display in the Indirect Connection method or the Direct Connection method are read from the PC.
Read Displayed Character-string Memory Table (See ③(vi) of Flowchart)	The contents of the word used by the character-string memory table for display in the Indirect Connection method or the Direct Connection method are read from the PC.
Read Bits (See ④ of Flowchart)	The PC reads the bits allocated for lamps and touch switches, and lights or turns them OFF as required.
Write Bits (See ⑤ of Flowchart)	The bit data is written to notify the PC that a touch switch was pressed.

Note Only bit, numeral and character-string memory table data for the currently displayed screens is written to the PC. Changes are not written to the PC if the contents of a non-displayed memory table are changed.

3-5 Checking the C200H Host Interface Settings

Use the PT Status Area check function to check the C200H Host Interface Unit settings.

Follow the procedure below to check the settings.

- 1, 2, 3...**
1. Display the PT System Menu.
 2. Select the Maintain Mode item. The Maintain Mode menu is displayed.
 3. Select the PT Setting item. The PT Settings are displayed.

4. Display the Host Link I/F Settings screen.

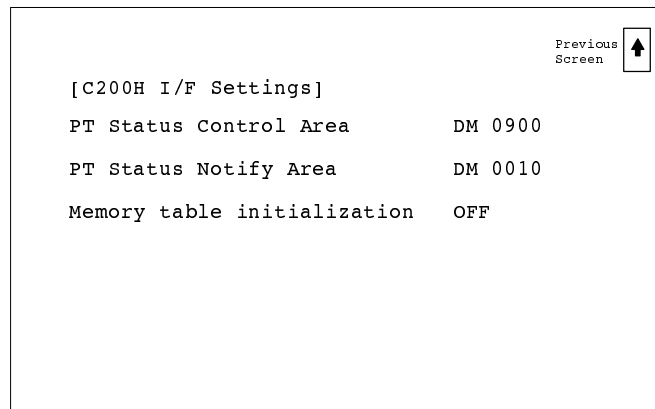

The PT Status Control Area and PT Status Notify Area are not displayed in the initialized status (i.e., before data transfer).

5. Check that the PT settings are the same as the C200H Host Interface Unit DIP switch (SW1) settings.

The menu selection differs according to the model and type of PT. Refer to the appropriate *PT Operation Manual* for details of menu operation.

SECTION 4

PT Operation

This section describes the actual operation of the PT using Direct Connection. Only the allocated bits and words are described related to the settings with the Support Tool. Refer to the *Support Tool and PT Operation Manuals* for details of other settings.

4-1	Using the PT	30
4-1-1	Before Using the PT	30
4-1-2	Creating Screen Data	31
4-1-3	Setting Direct Connection	33
4-2	Switching Displayed Screens	35
4-3	Changing Displayed Numerals or Character Strings	36
4-4	Editing Displayed Numerals or Character Strings	39
4-5	Changing Allocated Word Contents in Indirect Connection	42
4-6	Upgrading Bar Graphs	45
4-7	Controlling the PT Status	46
4-8	Turning Lamps and Touch Switches On and Off	49
4-9	Determining the Screen Displayed on the PT	50
4-10	Determining a Number Input to the PT	52
4-11	Determining PT Operating Status	55
4-12	Determining Touch Switch Status	57

4-1 Using the PT

How to create screen data, Direct Connection, and connecting the Support Tool are described below before the use of the PT is explained.

4-1-1 Before Using the PT

This section describes PC program creation and Support Tool screen data creation only as it relates to using the PT. For details of other procedures, refer to *1-4 System Configuration*.

Preparing to Operate the PT The relationship between PT, PC and Support Tool operations is shown below.

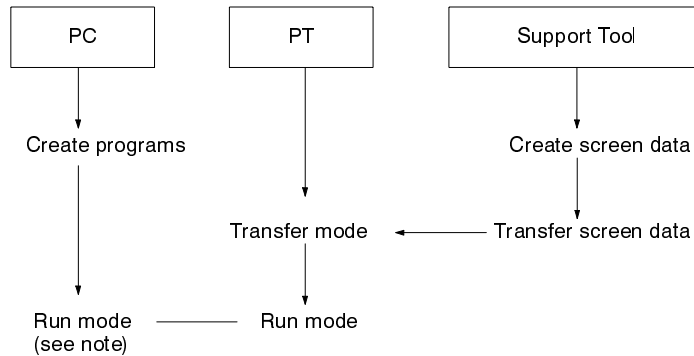

Note The PT reads and writes data to allocated bits and words in the PC even if the PC is not set to Run mode. Control of the PT and reading the status with the Peripheral Tool monitoring functions are also enabled.

Creating Screen Data

The PT switches the display between multiple screens. All screen data for a single PT corresponds to a single file.

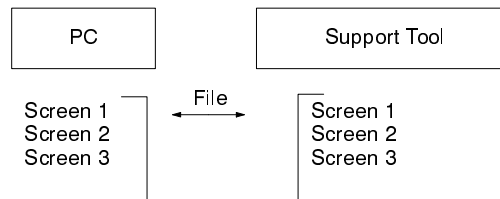

Screen data can be created by one of the following three methods:

- creating a new file;
- editing an existing file;
- reading and editing selected screens from an existing file.

Equipment

The following equipment and settings are used in the examples in this section:
General memory:

PT:

NT600M-DT211 (EL display, touch panel version NT600M)

PC:

OMRON C200H

The memory area used depends on the PC type. Refer to *Appendix B PC Memory Map* for details.

Support Tool

NT20M/NT2000M/NT600M Support Tool Version 4._

Direct Connection

OMRON

Set with the Tool Setting screen on the Support Tool. Refer to *4-1-3 Setting Direct Connection* for details.

4-1-2 Creating Screen Data

Screen data is created with the Support Tool. The basic procedure to create these screens is outlined below along with the relevant page number. The example describes the procedure for creating a new file using Support Tool version NT20M, NT2000M, or NT600M.

Tool Settings

- NTM model setting (PT model)
- Memory capacity setting (screen memory)
- Direct Connection (OFF, OMRON)

Main Menu

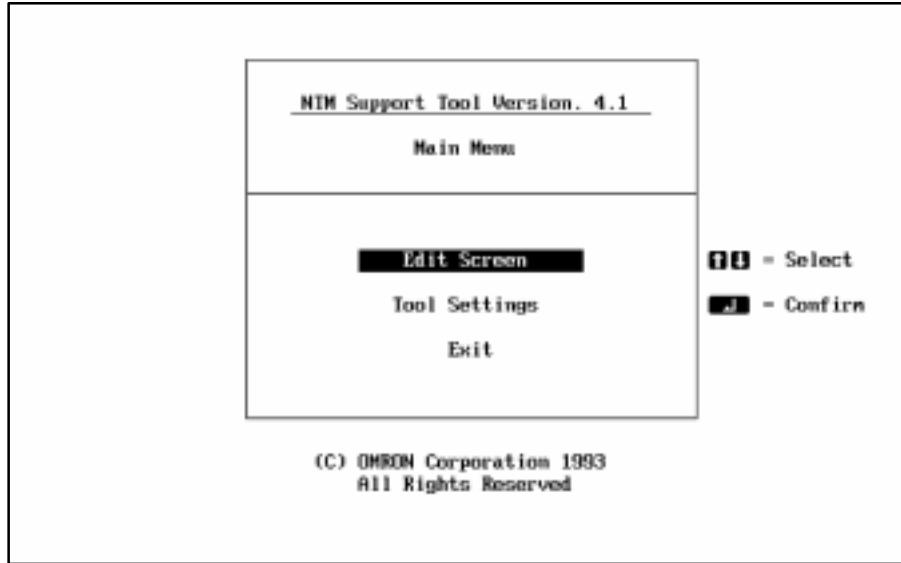

Create Screen

- Create new file: select New File
- Edit existing file: select file to edit

File Selection Menu

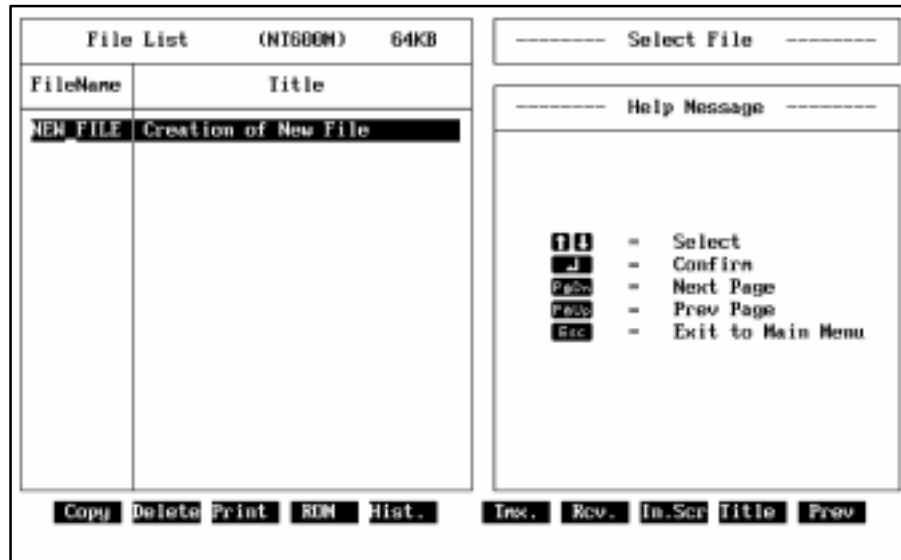

Create New File

Enter filename on completion.

Setting Direct Connection Information

Press the function key Prev followed by function key Direct to set the following data.

- PT Status Control Area (word allocation)
- PT Status Notify Area (word allocation)

- Numeral table (word allocation)
- Character-string memory table (word allocation)
- Reuse existing file: select Read

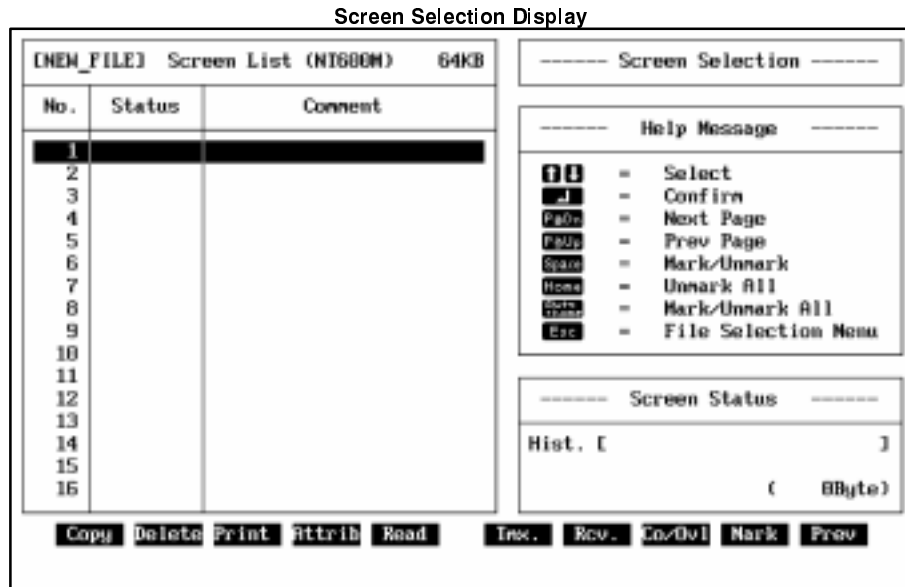

Select Screen

Creating Screen

The following screen will be displayed. Set the following data from this screen.

- Numeral display (numeral table selection)
- Character-string display (character-string memory table selection)
- Lamp (bit allocation)
- Touch switch (bit allocation for control and notification)
- Bar graph (numeral table selection)
- Set numbers (numeral table selection)

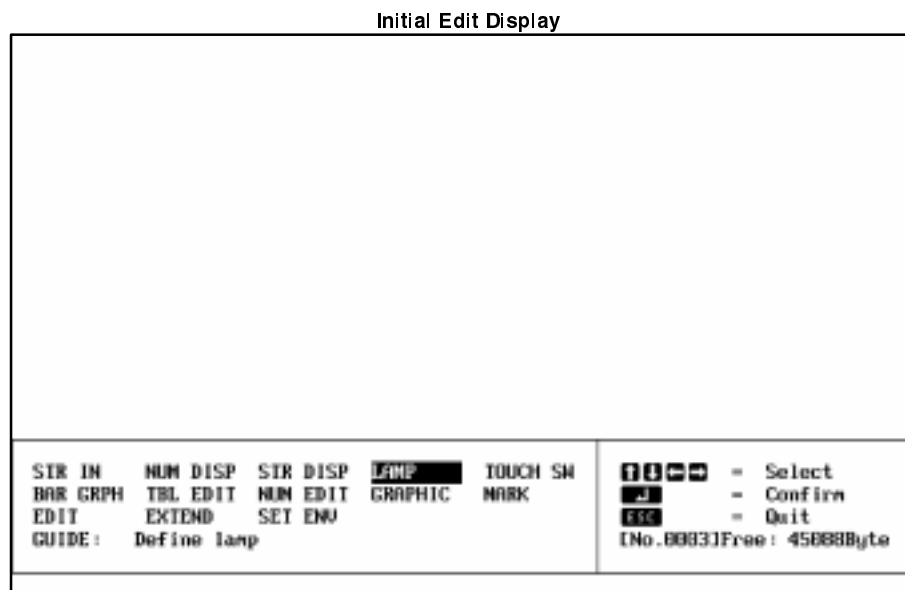

Complete Create Screen

Screen Selection Display

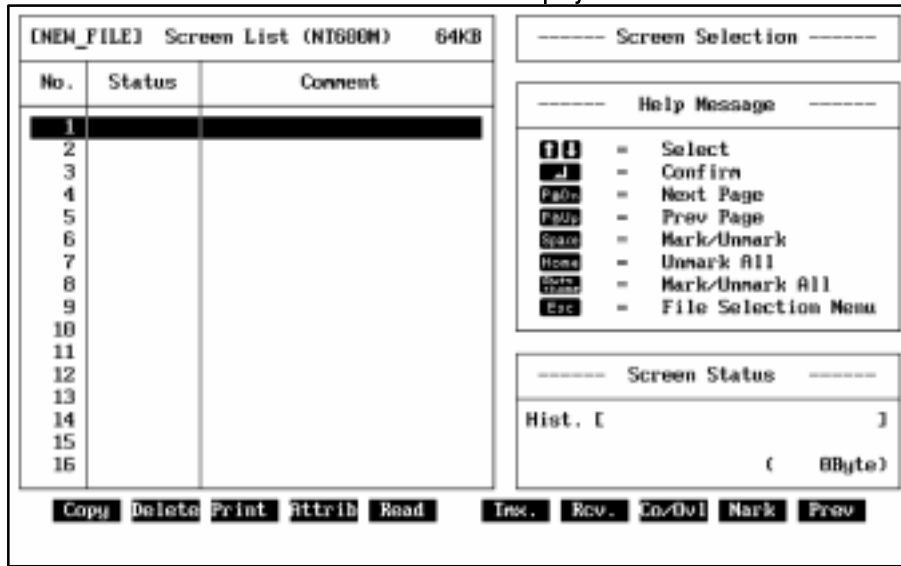

Complete Create File

Specify the filename for the newly created screen.

Set Start-up Screen Number

Press the function key F8: Start-up Screen. The following screen is displayed when the PT is booted up.

Transfer

Press the function key F6: Transfer. Transfer the created screen data to the PT.

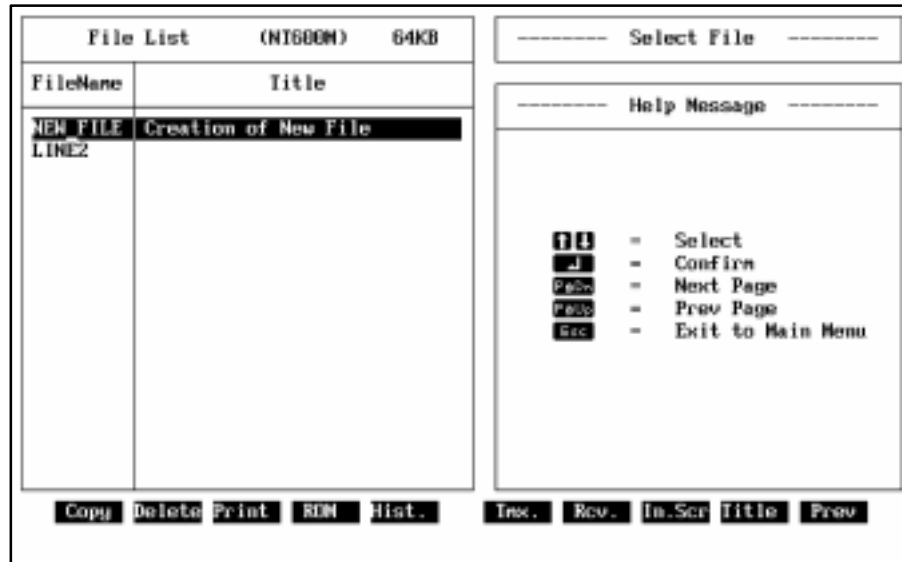

Transferring Data to the PT

To transfer the screen data to the PT, connect the PT and Support Tool together and set the PT in Transfer Mode.

When reusing existing file data with a different Direct Connection setting, change the settings as described in *Section 5 Converting Data*.

4-1-3 Setting Direct Connection

Set Direct Connection with the Support Tool before selecting a file. It is set from the Main Menu of the Tool Setting screen.

To select Direct Connection, set the Direct Connection item to either OMRON or ON (depending on the Support Tool version).

NT20M/NT2000M/NT600M Support Tool Version 4._

Tool Settings				
NT Model	NT20M	NT600M		
Memory Size	32 KB	64 KB	128 KB	256 KB
Direct setting	No	<u>Yes</u>		
Printer	Epson Dot Matrix		HP Laser	
Sheet Feeder	<u>Yes</u>	No		
Auto Refresh	Yes	No		
Display Grid	No	8-dot	16-dot	32-dot TouchSw
Communication Port	<u>COM1</u>	COM2		
Temporary Directory	\			
Data Directory	\			
Help Message	Set NT model		[F1] = Select Item [F2] = Change Setting [Enter] = Confirm [Esc] = Abort	
Confirm NT model				

Connecting to the Support Tool

The following equipment and software is required to create screens with the Support Tool:

Computer: PC/AT compatible computer.

Software:

NT20M/NT2000M/NT600M Support Tool Version 4. _

NT20M-ZASAT-EV4

Connecting cable: CV500-CN228, 2 m cable

Refer to the *NT-series Support Tool Operation Manual* for details on the Support Tool software and connecting cables.

Connections

Connect the computer RS-232C connector to the PT connector with the connecting cable as shown in the diagrams below.

NT20M (Front View)

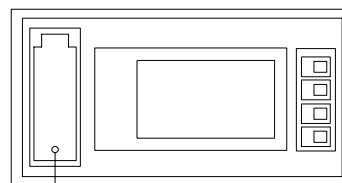

Connector is under the connector cover.

NT600M (Rear View)

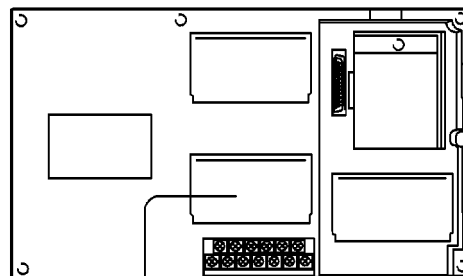

Connector is under the connector cover.

4-2 Switching Displayed Screens

Description

Write the screen number to the Screen Switch setting in the PT Status Control Area to switch the screen displayed on the PT.

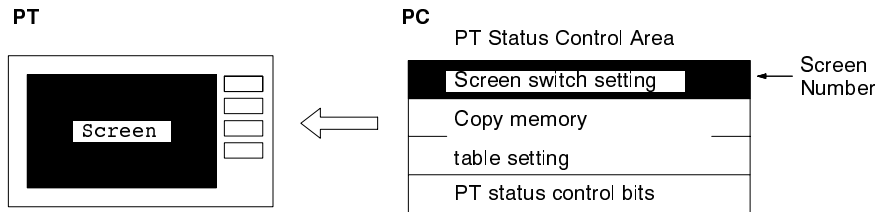

Allocated start address: Word n (set with the Support Tool)

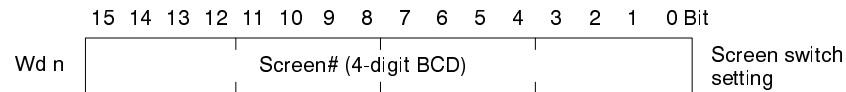

Screen#: 0000 (Screen clear — no display)
 0001 to 0250 (NT20M)
 0001 to 1000 (NT600M)

Restrictions

Allocated Words

The PT Status Control Area can be allocated to the areas listed in the following table.

Symbol	Area	Allocation OK?
DM	Data Memory	OK
I/S	Internal/Special Relay	OK
TIM	Timer	NG
CNT	Counter	NG
HR	Holding Relay	OK
AR	Auxiliary Relay	OK
LR	Link Relay	OK

The range of each memory area differs according to the PC type. Refer to *Appendix B PC Memory Map* for more details.

Procedure

- 1, 2, 3... 1. Use the Support Tool to allocate the PT Status Control Area to the PC memory.
2. Create a PC program to write the number of the displayed screen to the Screen Switch setting word in the PT Status Control Area as a 4-digit BCD (binary coded decimal) value.

Important Points

The displayed screen switches when the contents of the allocated word are changed. To re-specify the number of the currently specified screen, first write the value 0000 to clear the screen before writing the appropriate screen number. As shown in the example, it is also possible to use the function to notify which screen is currently displayed.

Reference

When the displayed screen is switched due to PT Status Control Area operation, the screen number is written to the Currently Displayed Screen word in PT Sta-

tus Notify Area. Refer to 4-9 *Determining the Screen Displayed on the PT* for details.

Continuous or superimposed screens can be displayed by specifying the parent screen. If a child screen is specified, only the child screen is displayed.

Refer to the appropriate *PT Operation Manual* and *NT-series Support Tool Operation Manual* for information about displaying continuous and superimposed screens.

One way to switch screens is to set the screen number to a touch switch with the Support Tool. Refer to the Stand-alone functions (screen switch function) in the appropriate *PT Operation Manual* and *NT-series Support Tool Operation Manual* for details.

Application Example

This example operates the PC switch (bit) to change the PT display screen.

Allocation

Allocate the memory as follows using the Support Tool:

PT Status Control Area: 0100

PT Status Notify Area: 0110

Screens

Create screens numbers 2 and 3 with the Support Tool and transfer them to the PT.

PC Program

Create a PC ladder program, as follows:

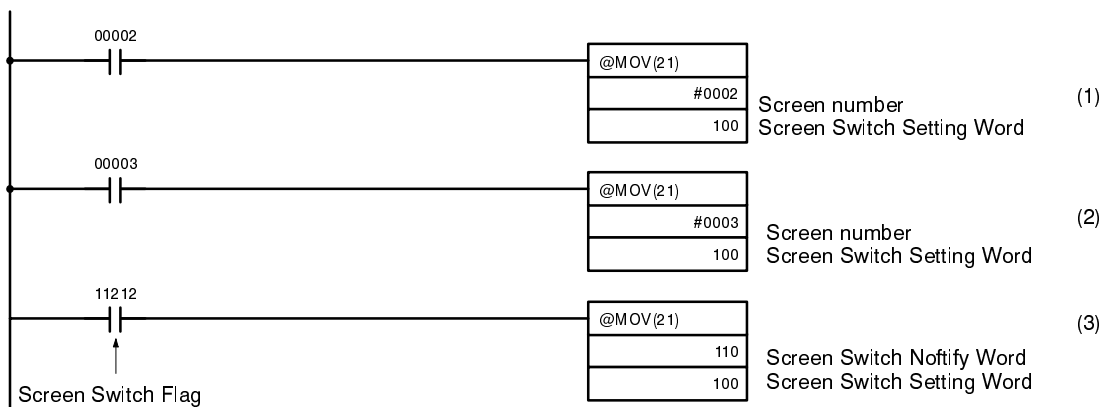

PT operation when the program is run is described below.

- 1, 2, 3...**
1. Screen number 2 is displayed on the PT when bit 00002 turns ON.
 2. Screen number 3 is displayed on the PT when bit 00003 turns ON.
 3. When the Screen Switch Flag turns ON the number of the currently displayed screen is read and written to the Currently Displayed Screen word in PT Status Notify Area. In this case, the same screen need not be written twice.

When a program is created as in (3) above, the screen can also be switched from the PT using the Stand-alone functions (screen switch function) and it is not necessary to input the same screen number twice. The step in (3) is not necessary if the Stand-alone functions are not used.

Refer to 4-9 *Determining the Screen Displayed on the PT* for more information on the Screen Switch Flag and notification of the currently displayed screen.

4-3 Changing Displayed Numerals or Character Strings

Description

The PT display can be changed by editing the contents of the numeral or character-string memory table used for the display.

The method described below for changing the display involves copying the contents of one memory table to another. Writing the source and destination memory table numbers to the Copy Memory Table Setting words of the PT Status Control Area allocated to the PC copies the contents of one memory table to another in the PT, which changes the display.

This is a convenient method to display predetermined numbers of character strings to suit the operating status. The changes are processed extremely rapidly as the PT Status Control Area is used.

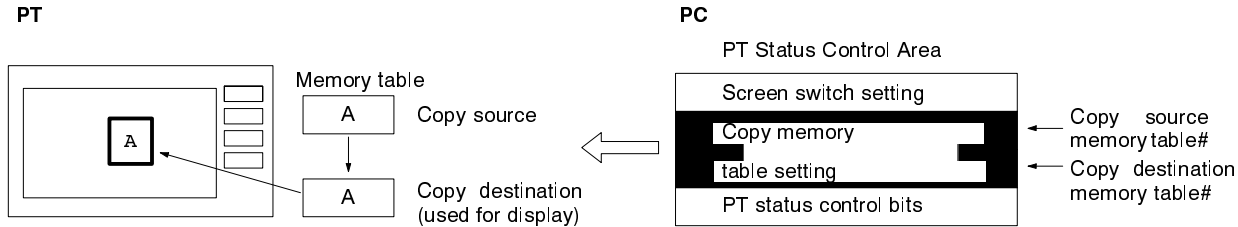

Allocated start address: Word n (set with the Support Tool)

	15	14	13	12	11	10	9	8	7	6	5	4	3	2	1	0	Bit
Word n + 1	0			Copy source memory table# (3-digit BCD)													
Word n + 2	Copy type			Copy destination memory table# (3-digit BCD)													

} Copy memory table setting

Copy Type

- 0: Copy character-string memory table
- 1: Copy numeral table

Character-string Memory Table Numbers

- 000 to 127 (NT20M)
- 000 to 255 (NT600M)

Numeral Table Numbers

- 000 to 127 (NT20M)
- 000 to 511 (NT600M)

Restrictions

Allocated Words

The PT Status Control Area can be allocated to the areas listed in the following table.

Symbol	Area	Allocation OK?
DM	Data Memory	OK
I/S	Internal/Special Relays	OK
TIM	Timer	NG
CNT	Counter	NG
HR	Holding Relay	OK
AR	Auxiliary Relay	OK
LR	Link Relay	OK

The range of each memory area differs according to the PC type. Refer to *Appendix B PC Memory Map* for more details.

Procedure

- 1, 2, 3... 1. Use the Support Tool to allocate the PT Status Control Area to the PC memory.
2. Specify the memory table to be displayed with the Screen Create functions of the Support Tool.
Specify a numeral table for a numeral display.

Specify a character-string memory table for a text display.

3. Use the Table Edit functions to write the contents of the copy source memory table.
4. Create a PC program to write the data described in (2) and (3) above to the Copy Memory Table setting words in the PT Status Control Area.

Important Points

In some cases the PT will read the specified area while the instructions are being written to the PT Status Control Area.

Therefore when using this method, be sure to write the copy destination memory table number word n+2 before writing the copy source memory table number Word n+1. The data may be written to an incorrect memory table if the copy source memory table number is specified first.

The PT reads only the words allocated to the memory tables displayed on the screen. If words are allocated to the copy source memory table, they are used during initialization only.

The display may be incorrect when a numeral table is copied if the display method or number of stored addresses differ.

The copy is not executed if the Copy Type is set to a value other than 0 or 1.

The memory table is copied only when the contents change. To make repeated copies between the same source to destination memory table, set the Copy Type to a value other than 0 or 1 then reset it to the correct value.

Reference

Prepare a number of copy source memory tables in advance and use them to switch the display to suit the operating status.

Application Example

This example switches the displayed screen by copying the character-string memory table.

Allocation

Allocate the memory as follows using the Support Tool:

PT Status Control Area: 0100

Screens

Use the Support Tool to create a screen which displays character-string memory table entry #4 and transfer it to the PT.

Set the initial values of the character-string memory table as shown below. It is not necessary to allocate addresses.

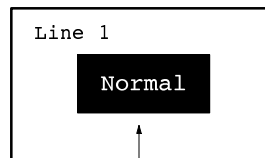

Character-string memory table entry #4

#	Contents	No. of characters
4	Normal	6 chars
10	Error	6 chars
11	Normal	6 chars

PC Program

Create a PC ladder program, as follows:

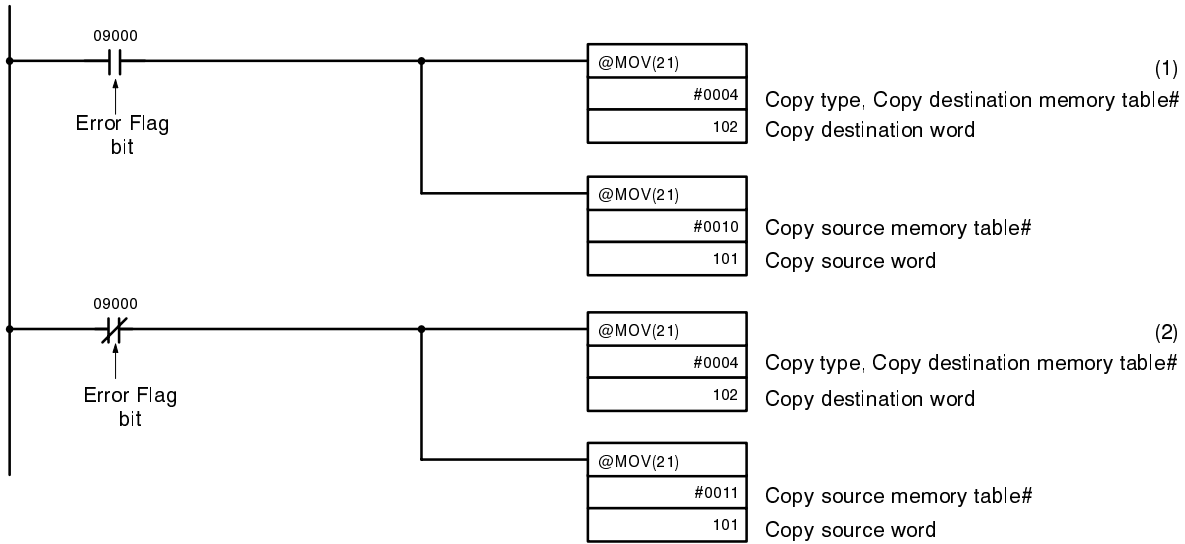

PT operation when the created screen is displayed and the program is run is described below.

- 1, 2, 3... 1. The Error Flag (bit 09000) turns ON and the PT displays the message “Error” when an error occurs.
- 2. The Error Flag (bit 09000) turns OFF and the PT display reverts to “Normal” when the error is cleared.

Note Specify the copy destination memory table before the copy source memory table.

4-4 Editing Displayed Numerals or Character Strings

Description

The PT display can be changed by editing the contents of the numeral or character-string memory table used for the display.

The method described below for changing the display involves editing the contents of the PC memory allocated to the memory table.

This is a convenient method to display changes in memory contents when monitoring the PC memory.

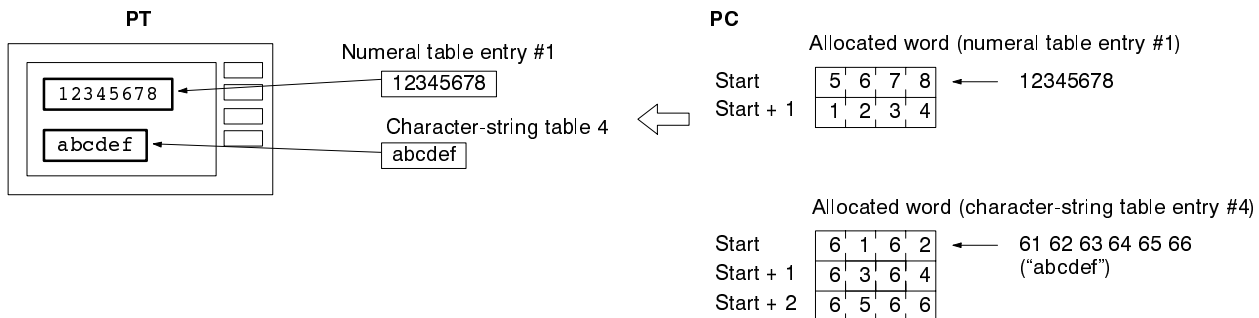

Allocate the words using the Support Tool.

Restrictions

Allocated Words

The number of words which can be allocated is shown in the table below.

Memory table	Words
Numeral	1 or 2 words
Character-string	NT20M: 1 to 16 words (2 to 32 normal characters) NT600M: 1 to 20 words (2 to 40 normal characters)

The memory table can be allocated to the areas listed in the following table.

Symbol	Area	Numeral	Character-string
DM	DM Area	OK (1 or 2 words for numeral tables)	OK (1 or 2 words for numeral tables)
I/S	IR/SR Area	OK (1 or 2 words for numeral tables)	OK (1 or 2 words for numeral tables)
TIM	Timer Area	1 word only	NG
CNT	Counter Area	1 word only	NG
HR	Holding Relay	OK (1 or 2 words for numeral tables)	OK (1 or 2 words for numeral tables)
AR	AR area	OK (1 or 2 words for numeral tables)	OK (1 or 2 words for numeral tables)
LR	Link Area	OK (1 or 2 words for numeral tables)	OK (1 or 2 words for numeral tables)

The range of each memory area differs according to the PC type. Refer to *Appendix B PC Memory Map* for more details.

Contents and Display of Allocated Words

Numerals

Numbers are stored in the allocated words as shown below.

Stored as a single word

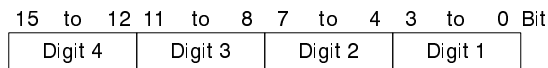

Example: 1234

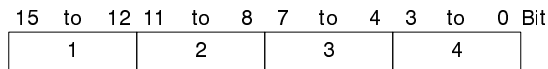

Stored as a double words

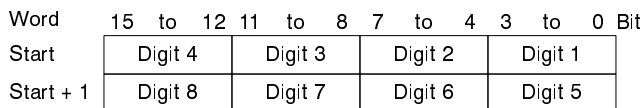

Example: 12345678

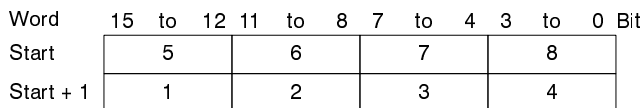

Numbers can be handled in three different ways. The most-significant digit is processed differently according to the type of numeral display, as follows:

Hexadecimal display: display of all digits identical to the contents of the allocated words;

Decimal, no sign: an "F" as the most-significant digit is displayed as "0," any other value as the most-significant digit and all other digits are displayed identical to the contents of the allocated words;

Decimal, with sign: an "F" as the most-significant digit is displayed as a minus sign (-), any other value as the most-significant digit and all other digits are displayed identical to the contents of the allocated words;

Screens

Use the Support Tool to create a screen which displays numeral table numbers 1 and 2 and transfer it to the PT.

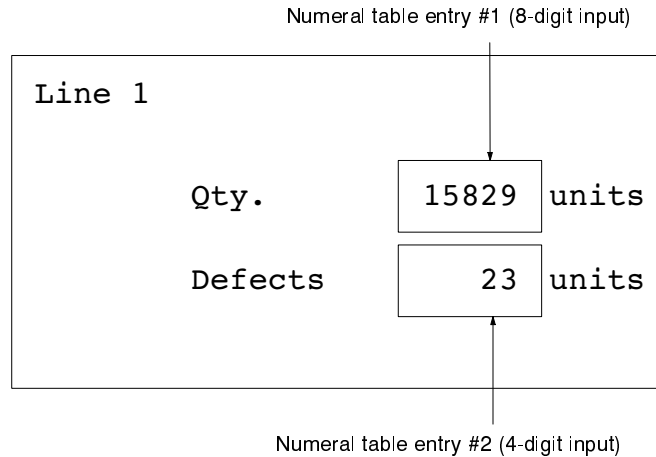

PC Program

Create a PC ladder program, as follows:

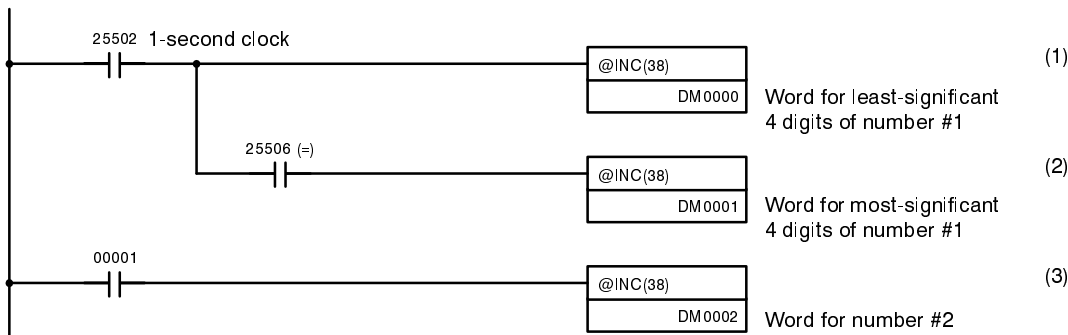

PT operation when the created screen is displayed and the program is run is described below.

- 1, 2, 3...**
1. The contents of word 0000 are incremented by 1 each second. The displayed value in the numeral table entry entry number1 is increased by 1 each second.
 2. When the counter in (1) causes an increase in the most-significant digits, the contents of word 0001 are incremented by 1. The displayed value in the PT numeral table entry number1 most significant digits is increased by 1.
 3. When bit 00001 turns ON the contents of 0002 are incremented by 1. The displayed value in the PT numeral table entry number 2 is increased by 1.

4-5 Changing Allocated Word Contents in Indirect Connection

Description

In the Indirect Connection method, a numeral table is specified to display a value or character-string, and the value of the numeral table will become the memory table number to be used for display. In the following example, 39 is used as the value of the numeral table.

There are two ways to change the display:

- 1, 2, 3...**
1. Change the memory table number to be displayed. In the following example, the contents of numeral memory table 41 is changed. This section provides further details on this method.

- Change the memory table contents used for display. In the following example, the contents of character-string memory table 39 is changed. Refer to 4-3 Changing Displayed Numerals or Character Strings and 4-4 Editing Displayed Numerals or Character Strings for details.

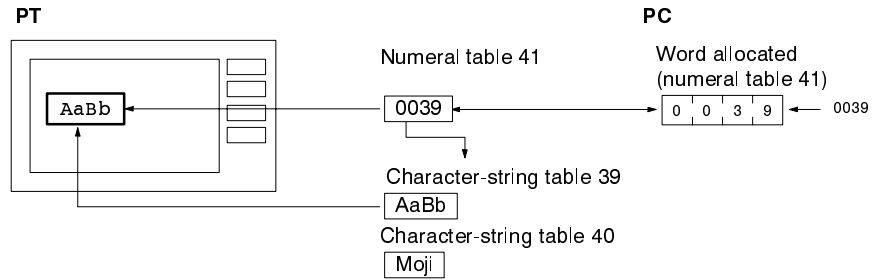

Use the Support Tool for word allocation of the numeral table to be used in the Indirect Connection method when displaying a value or character-string.

Restrictions

Allocated Words

The number of words which can be allocated in the Indirect Connection method is shown in the table below.

Memory table	Words
Numeral	1 or 2 words

The memory table number to be displayed can be selected from the following value ranges. The memory table number consists of four digits maximum so that the user is able to allocate only a single word.

Mode	NT20M	NT600M
Numeral display	000 to 127	000 to 511
Character-string display	000 to 127	000 to 255

The numeral table can be allocated to the following area.

Symbol	Area	Allocation
DM	Data Memory	OK (1 or 2 words for numeral tables)
I/S	Internal/Special Relay	OK (1 or 2 words for numeral tables)
TIM	Timer	1 word only
CNT	Counter	1 word only
HR	Holding Relay	OK (1 or 2 words for numeral tables)
AR	Auxiliary Relay	OK (1 or 2 words for numeral tables)
LR	Link Relay	OK (1 or 2 words for numeral tables)

The range of each memory area varies according to the PC type. Refer to Appendix A PC Memory Map for more details.

Refer to 4-4 Editing Displayed Numerals and Character Strings for information on saving a value and character string to the allocated word of the numeral table or character-string memory table to be used for display, or to the allocated word of the numeral table to be used in the Indirect Connection method.

Procedure

- 1, 2, 3... 1. Use the Support Tool to specify the PC area for the numeral table to be used for numeral and character-string display in the Indirect Connection method.
2. Use the Table Edit function of the Support Tool to write the contents to be displayed to the memory table to be used for display.

- Specify a numeral table for a numeral display.
- or Specify a character-string memory table for a text display.
- 3. Create a program on the PC to change the contents of the allocated word of the numeral table to be used in the Indirect Connection method.

Application

This example changes the displayed character string by adding the contents of the PC word for the numeral table to be used in the Indirect Connection method.

Allocation

Allocate the memory as follows using the Support Tool:
numeral table entry #51: 0000 (number of words: 1)

Screens

Use the Support Tool to create a screen which displays character-string memory table entry #51 in the Indirect Connection method as shown below and transfer it to the PT. Set numeral table number 51 to 100 as the initial value. Set initial values to character-string memory tables 100 and 103 as shown below. There is no need to allocate words.

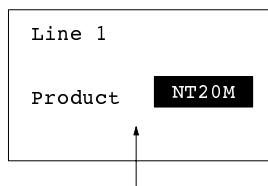

This character-string memory table is indirectly specified with numeral memory table #51.

#	Contents	No. of characters
100	NT20M	7 chars
101	NT600M	7 chars
102	NT10S	7 chars
103	NT2000M	7 chars

PC Program

Create a PC ladder program, as follows:

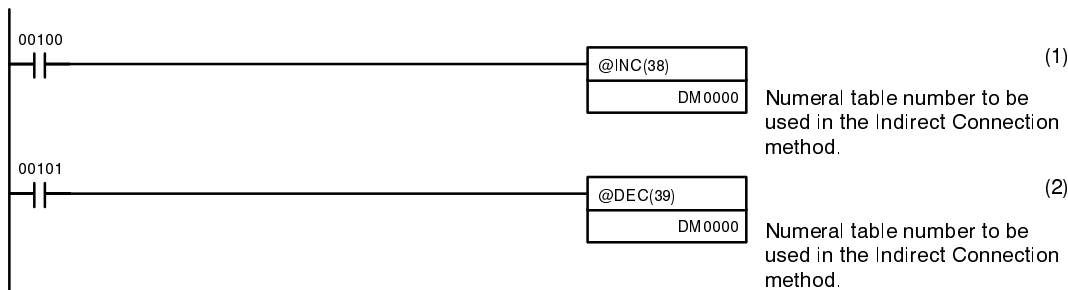

PT operation when the created screen is displayed and the program is run as described below.

- 1, 2, 3...**
1. When bit 00100 is ON, the PT's display changes from NT20M to NT600M, and from NT10S to NT2000M.
 2. When bit 00101 is ON, the PT's display changes from NT2000M to NT10S, and from NT600M to NT20M.

4-6 Upgrading Bar Graphs

Description

The bar graph can be upgraded by editing the contents of the memory table used for the bar graph.

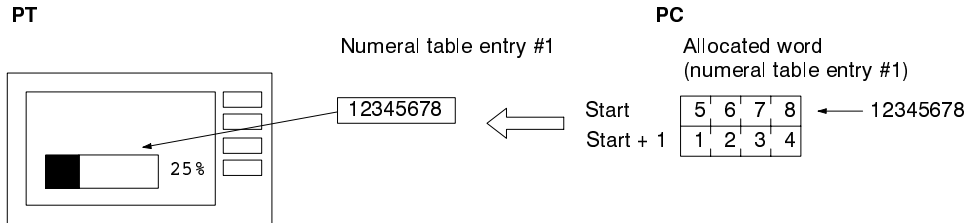

Allocate words using the Support Tool.

Restrictions

Allocated Words

The number of words which can be allocated is shown in the table below.

Memory table	Words
Numeral	1 or 2 words

The memory table can be allocated to the areas listed in the following table.

Symbol	Area	Allocation OK?
DM	Data Memory	OK (1 or 2 words for numeral tables)
I/S	Internal/Special Relay	OK (1 or 2 words for numeral tables)
TIM	Timer	1 word only
CNT	Counter	1 word only
HR	Holding Relay	OK (1 or 2 words for numeral tables)
AR	Auxiliary Relay	OK (1 or 2 words for numeral tables)
LR	Link Relay	OK (1 or 2 words for numeral tables)

The range of each memory area differs according to the PC type. Refer to *Appendix B PC Memory Map* for more details.

Refer to *4-4 Editing Displayed Numerals and Character Strings* for information on saving numbers to allocated words.

- Note**
1. A bar graph cannot be used to display hexadecimal values. The display will not change even if hexadecimal values are specified.
 2. A bar graph cannot be used to specify any numeral table indirectly. Even if a numeral table is specified indirectly, it will be regarded as Direct Connection.
 3. If the value is in decimal, no sign display is selected and an "F" is written to the most-significant digit of the word allocated to the bar graph (which represents a minus sign). The bar graph displays zero and the percent display indicates "0".

4-7 Controlling the PT Status

Description

Write the control data to the PT Status Control bits in the PT Status Control Area allocated in PC memory to control the backlighting, buzzer, etc.

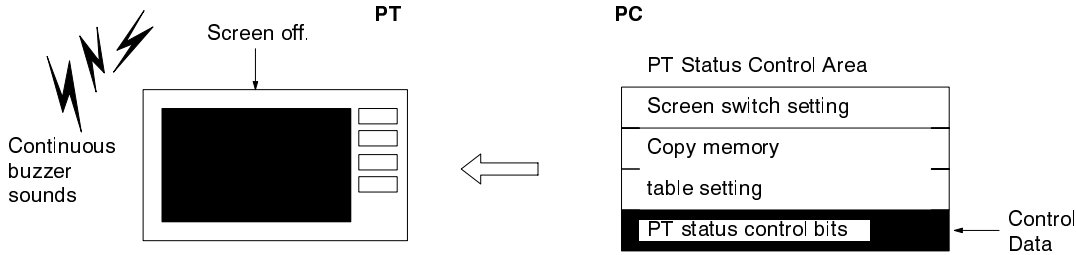

Allocated start address: Word n (set with the Support Tool)

Word	15	14	13	12	11	10	9	8	7	6	5	4	3	2	1	0	Bit
n + 3	PT status control bit										0	0	PT status control bits				

PT Status Control bits:

Word	15	14	13	12	11	10	9	8	Bit
n + 3									

Turn bits 7 to 0 OFF.

Bit	Controlled item	1 (ON)	0 (OFF)
15	Screen display	ON	OFF
14	Alarm output	ON	OFF
13	Continuous buzzer	ON	OFF
12	Intermittent buzzer	ON	OFF
11	Initialize display history	ON	OFF
10	Backlight color	Red	White
8	Backlight mode	Continuous light	Flash

Note Bit 10 (Backlight color) is valid for the NT20M.
 Bit 8 (Backlight mode) is valid for the NT20M.
 Bit 15 (Screen display) when used for a LCD (liquid-crystal display) backlighting turns on if the Screen Display bit is set to ON and turns off if the Screen Display bit is set to OFF. For EL operation, screen display operation is controlled.

Screen Display (Bit 15)

The Screen Display bit is used to display and clear the screen to prevent “burn in” on the CRT.

Set Bit 15 to 0 (OFF) to clear the screen. To restore the screen display, set Bit 15 to 1 (ON) , or press the System key or touch switch. On the LCD display version PT, the bit acts to turn the backlight on and off.

Another method of restoring the screen is to display a screen using the Screen Switch setting bit.

Alarm Output (Bit 14)

The Alarm Output bit turns on and off the ALM OUTPUT terminals at the rear of the PT.

Alarm Output control with Bit 14 is enabled only when the alarm output is turned on with the PT memory switches.

Refer to the appropriate *PT Operation Manual* and the *NT-series Support Tool Operation Manual* for more details.

Continuous (Bit 13) and Intermittent (Bit 12) Buzzers

The continuous buzzer sounds continually without interruption.

The intermittent sounds for 0.5 s at 0.5 s intervals.

If both Bit 13 and Bit 12 are turned ON simultaneously, Bit 13 takes priority and the continuous buzzer is selected.

Buzzer control with these bits is enabled only when the buzzer is turned on with the PT memory switches.

Refer to the appropriate *PT Operation Manual* and the *NT-series Support Tool Operation Manual* for more details.

Initialize Display History (Bit 11)

The Initialize Display History initializes the display history stored in the PT.

The display history is initialized when Bit 11 is set from 0 (OFF) to 1 (ON). Bit 11 reverts to 0 (OFF) after the display history is initialized.

Backlight Color (Bit 10) and Mode (Bit 8)

The NT20M allows backlighting to be controlled as follows using combinations of Bit 10 and Bit 8.

Bit		Backlight status when Bit 15 set 1 (ON)
10	8	
0	0	White flash (white ON – OFF)
0	1	White on
1	0	Red flash (red ON – OFF)
1	1	Red on

When backlighting is turned OFF (Bit 15 is set to 0 (OFF)), the backlight color (red or white) and backlight mode (continuous or flashing) are invalid.

In addition to the PT Status Control Area, the PT status can be controlled by setting the screen attributes with the Support Tool, as follows:

Alarm: Alarm output ON/OFF

Buzzer attribute: Continuous, Intermittent, OFF

Backcolor: White backlighting, Red backlighting

Backlighting: Backlighting ON/OFF

In addition, the display (or backlighting) is turned off if the PT is unused for a certain time if the PT memory switches are set to enable the burn-in prevention feature (EL display version) or the backlight control feature (LCD display version).

Refer to the appropriate *PT Operation Manual* and the *NT-series Support Tool Operation Manual* for more details.

Note The PT Status Control bits remain unchanged if the PT status is changed with the screen attributes or memory switches, so that the status of the PT Status Control bits do not match the actual PT status.

Example: The continuous buzzer may sound if the status of Continuous Buzzer bit 13 is 0 (OFF).

Restrictions

Allocated Words

The PT Status Control Area can be allocated to the areas listed in the following table.

Symbol	Area	Allocation OK?
DM	Data Memory	OK
I/S	Internal/Special Relay	OK
TIM	Timer	NG
CNT	Counter	NG
HR	Holding Relay	OK
AR	Auxiliary Relay	OK
LR	Link Relay	OK

The range of each memory area differs according to the PC type. Refer to *Appendix B PC Memory Map* for more details.

Procedure

- 1, 2, 3...**
1. Use the Support Tool to allocate the PT Status Control Area to the PC memory.
 2. Create a PC program to write the control status to the PT Status Control bits in the PT Status Control Area.

- Note**
1. The PT Status Control Area is not read immediately after the PT is booted up. The PT Status Control Area is read and control executed when the control status is changed.
 2. The control of PT status is executed when the status of a bit is changed. To revert to the control status before the change, set all the PT status control area back to the status it had before the change.
 3. During PT control operations, screen attributes such as a buzzer and alarm have priority.

Application

This example controls the PT status to use the PT as a warning lamp.

Allocation

Allocate the memory as follows using the Support Tool:

PT Status Control Area: 0100

Screens

Not specified.

PC Program

Create a PC ladder program, as follows:

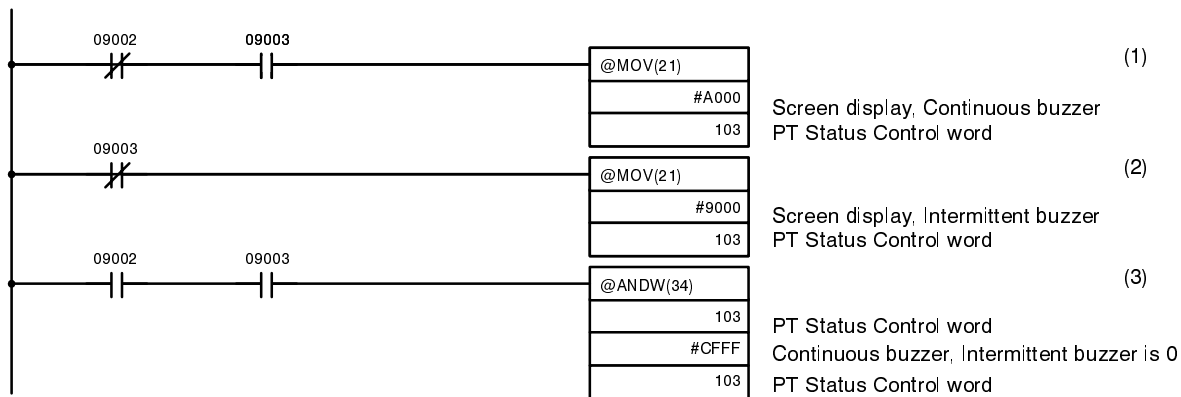

PT operation when the program is run is described below.

- 1, 2, 3...**
1. PT Status Control bits are set as shown below when bit 09002 turns OFF. This command block not executed when bit 09003 is OFF.
 - Screen display (Bit 15): 1 (ON)

- Continuous buzzer (Bit 13): 1 (ON)
The PT continuous buzzer sounds.
- 2. PT Status Control bits are set as shown below when bit 09003 turns OFF.
 - Screen display (Bit 15): 1 (ON)
 - Intermittent buzzer (Bit 12): 1 (ON)
The PT intermittent buzzer sounds.
- 3. PT Status Control bits are set as shown below when both bits 09002 and 09003 turn ON.
 - Continuous buzzer (Bit 13): 0 (OFF)
 - Intermittent buzzer (Bit 12): 0 (OFF)
The PT buzzer stops.

4-8 Turning Lamps and Touch Switches On and Off

Description

The lamps and touch switches are lit (flashed) and extinguished by setting bits allocated in the PC memory as the lamp and touch switch control bits ON (1) or OFF (0).

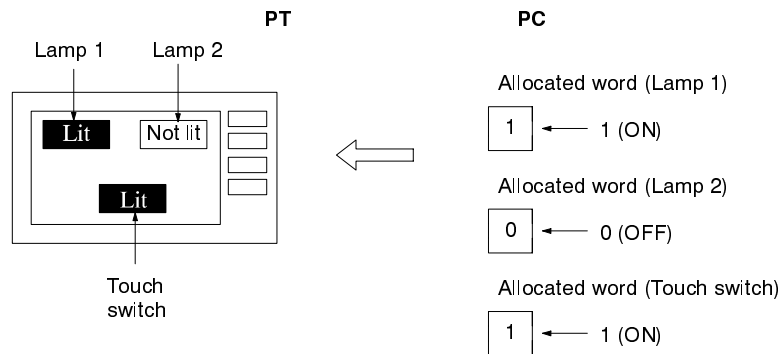

Allocate the control bits with the Support Tool. The control bits control the status of lamps and touch switches as follows:

- 0 (OFF): Not lit
- 1 (ON): Lit or flashing

The lamp and touch switch display attributes are set with the Support Tool to determine if the lamp or touch switch lights continuously or flashes. Refer to the *NT-series Support Tool Operation Manual* for details.

Restrictions

Allocated Bits

The lamp and touch-switch control bits can be allocated to the areas listed in the following table.

Symbol	Area	Allocation OK?
DM	Data Memory	OK
I/S	Internal/Special Relay	OK
TIM	Timer	NG
CNT	Counter	NG
HR	Holding Relay	OK
AR	Auxiliary Relay	OK
LR	Link Relay	OK

The range of each memory area differs according to the PC type. Refer to *Appendix B PC Memory Map* for more details.

Procedure

- 1, 2, 3... 1. Use the Support Tool to allocate the lamp and touch switch Control Bits to the PC memory. Use the display attributes to set if each lamp and touch switch flashes or lights continuously.
2. Create a PC program to set the Control Bits on or off to light (flash) or extinguish each lamp and touch switch.

Reference

Notify bits can be allocated to lamps and touch switches in addition to the control bits. The notify bits inform the PC whether a touch switch has been pressed. Refer to 4-12 *Determining Touch Switch Status*.

A touch switch is “lit” by highlighting the displayed touch switch.

Application Example

This example controls the bits to move a robot arm and turning the lamps on and off.

Allocation

Allocate the memory as follows using the Support Tool:

- Lamp #0: 00200 (output bit to raise robot arm)
- Lamp #1: 00201 (output bit to lower robot arm)
- Lamp #2: 00202 (output bit to rotate robot arm counterclockwise)
- Lamp #3: 00203 (output bit to rotate robot arm clockwise)
- Lamp #4: 00204 (output bit to clamp rotate robot arm)
- Lamp #5: 00205 (output bit to unclamp rotate robot arm)

Screens

Create a screen as shown below to display Lamps #0 to #5 with the Support Tool and transfer it to the PT. Set the display attribute to “Light”.

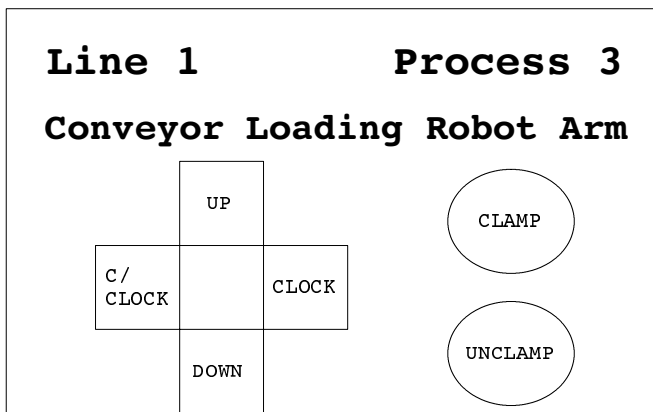

- Raise: Lamp#0
- Lower: Lamp#1
- Counterclockwise: Lamp#2
- Clockwise: Lamp#3
- Clamp: Lamp#4
- Unclamp: Lamp#5

PC Program

No PC ladder program is required to control the PT. Only a program to control the robot arm movement is required.

When the ladder program is executed to control the robot arm, the PT lamps turn on and off in synchronization with the arm movement.

For example, Lamp#0 lights when the robot arm ascends and goes out when it stops ascending.

4-9 Determining the Screen Displayed on the PT

Description

The screen displayed on the PT can be determined by reading the Currently Displayed Screen from the the PT Status Notify Area allocated in the PC memory. When the screen is switched, the PT Status Notify Area is notified as follows:

Switch notification: PT Status Display Switch Flag

New Screen number: Currently Displayed Screen

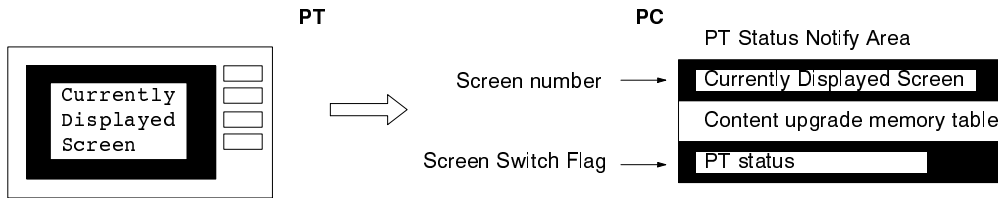

Allocated start address: Word n (set with the Support Tool)

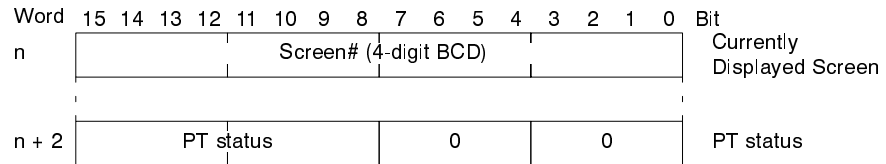

Screen#: 0000 to 0250 (NT20M)
0000 to 1000 (NT600M)

Screen Switch Flag

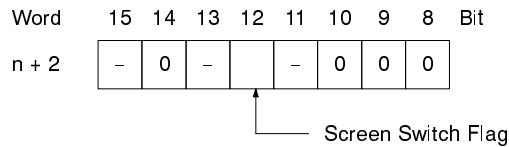

Restrictions

Allocated Words

The PT Status Notify Area can be allocated to the areas listed in the following table.

Symbol	Area	Allocation OK?
DM	Data Memory	OK
I/S	Internal/Special Relay	OK
TIM	Timer	NG
CNT	Counter	NG
HR	Holding Relay	OK
AR	Auxiliary Relay	OK
LR	Link Relay	OK

The range of each memory area differs according to the PC type. Refer to *Appendix B PC Memory Map* for more details.

Procedure

- 1, 2, 3... 1. Use the Support Tool to allocate the PT Status Notify Area to the PC memory.
2. Create a PC program to read the Currently Displayed Screen from PT Status Notify Area.
The screen# is handled as a 4-digit BCD (binary coded decimal) value.

Reference

The Currently Displayed Screen is upgraded when the screen is switched with the stand-alone function. Refer to the Stand-alone functions (screen switch function) in the PT User’s Manuals for details.

The PT Status Display Switch bit turns ON (1) in the PT Status Control Area when the screen display switches. It reverts to OFF (0) when the PC is notified of

the screen switch. The current screen# can be read by reading the Currently Displayed Screen when the PT Status Display Switch bit turns ON (1).

The number of the parent screen is notified if continuous screens or superimposed screens are displayed.

Application Example

This example reads the screen# each time the PT screen display switches.

Allocation

Allocate the memory as follows using the Support Tool:

PT Status Control Area: 0100

PT Status Notify Area: 0110

Screens

Create several screens which can be switched with the Support Tool and transfer them to the PT.

PC Program

Create a PC ladder program, as follows:

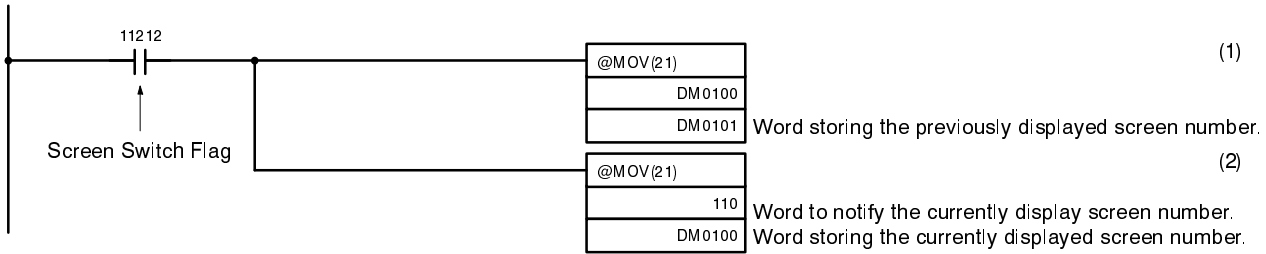

PT operation when the program is run is described below.

- 1, 2, 3...**
1. When the PT screen display switches and the screen switch flag (Bit: 11212) turns ON, the contents of DM 0100 are transferred to DM 0101. The number of the previously displayed screen is stored in word 0101.
 2. The new screen number notified by the PT is read and transferred to DM 0100. The number of the currently displayed screen is stored in DM 0110.

4-10 Determining a Number Input to the PT

Description

The PT can be used as a numeric keypad to write numbers to a numeral table. When a number is written to a numeral table with this so-called “number setting function” an area allocated in PC memory is notified as follows:

Upgrade notify: PT Status Number Setting Flag

Upgraded table entry number: Upgraded memory table

Upgrade details: numeral table allocated word

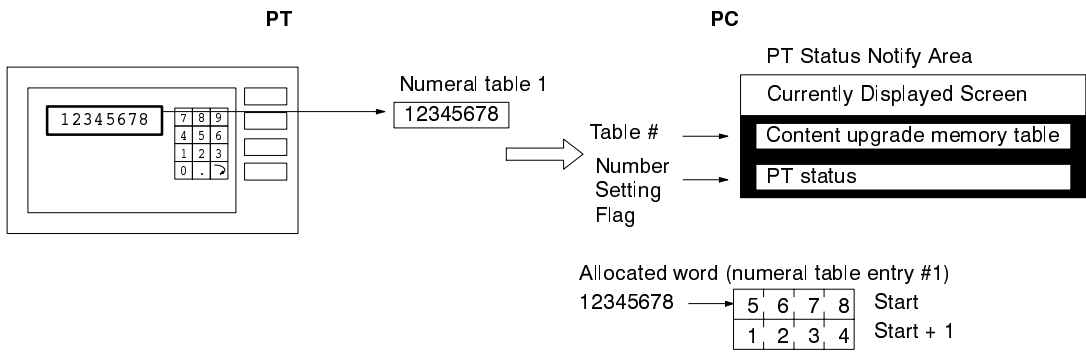

Allocated start address: Word n (set with the Support Tool)

Word	15	14	13	12	11	10	9	8	7	6	5	4	3	2	1	0	Bit
n + 1	0				Numeral table# (3-digit BCD)								Content upgrade memory table				
n + 2	PT status				0				0				PT status				

Screen#: 000 to 127 (NT20M)
 000 to 511 (NT600M)

Number Setting Flag

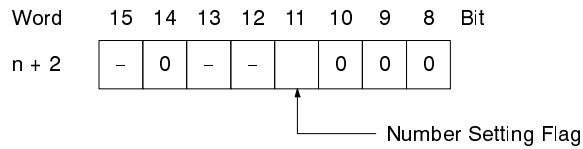

Restrictions

Allocated Words

The PT Status Notify Area can be allocated to the areas listed in the following table.

Symbol	Area	Allocation
DM	Data Memory	OK (1 or 2 words for numeral tables)
I/S	Internal/Special Relay	OK (1 or 2 words for numeral tables)
TIM	Timer	1 word only
CNT	Counter	1 word only
HR	Holding Relay	OK (1 or 2 words for numeral tables)
AR	Auxiliary Relay	OK (1 or 2 words for numeral tables)
LR	Link Relay	OK (1 or 2 words for numeral tables)

The range of each memory area differs according to the PC type. Refer to *Appendix B PC Memory Map* for more details.

Contents and Display of Allocated Words

Numbers are stored in the allocated words as shown below.

Stored as a single word

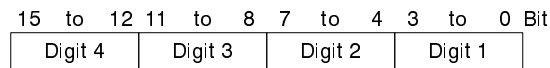

Example: 1234

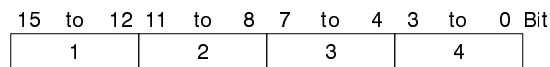

Stored as a double words

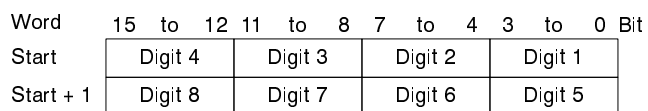

Example: 12345678

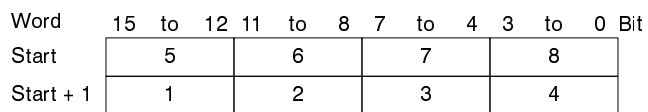

Note The order in which the numbers are stored in the allocated words depends on the original specification of the C200H Host Interface Unit NT20M-SMR02-E or NT600M-SMR02-EV□. Refer to *5-4 Modifying Programs for Conversion*.

Numbers can be handled in the following three different ways:

- Hexadecimal: Cannot be input with the number setting function.
- Decimal, no sign: Stored as entered.

- Decimal, with sign: For a negative number, an “F” is stored as the most-significant digit, all other digits stored as entered. A positive number is stored as entered.

Examples:

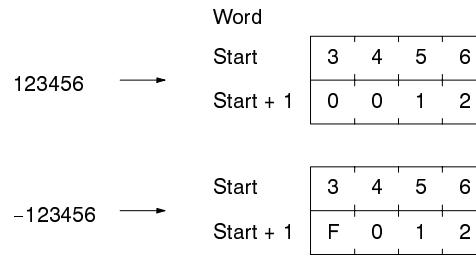

- Note**
1. If a negative values is written when the value is handled as a decimal display with sign, an “F” as the most-significant digit represents the minus sign. Consequently, the number of digits in a negative number is one less than for a positive number.
 2. All numbers are stored as integers. If a decimal point is input, the position of the decimal point is determined by the display method setting. The input number cannot therefore be determined from the contents of the memory word.

Procedure

- 1, 2, 3...**
1. Use the Support Tool to allocate the PT Status Notify Area to the PC memory.
 2. Use the Support Tool to create a number setting screen and allocate a numeral table to the PC memory area.
 3. Create a PC program to read the PT content upgrade memory table when the PT Status Number Setting Flag in the PT Status Notify Area turns ON (1). The contents of the PT content upgrade memory table are handled as 3-digit BCD (binary coded decimal) values.
 4. Read the words allocated to the numeral table allocated at step (3).

Important Points

The Number Setting Flag turns OFF (0) when the PC has been notified. Therefore, always read the PT content upgrade memory table when this flag turns ON (1).

Numbers input to the PT are stored in the words allocated to the numeral table as BCD (binary coded decimal) values. The most-significant digit is treated differently for positive and negative values. Consider these restrictions when creating the PC program to read the contents of the allocated words.

Application Example

This example reads the contents of the numeral table input from the PT

Allocation

Allocate the memory as follows using the Support Tool:

PT Status Control Area: 0110

Numeral table entry number 3: DM 0003 (words: 1)

Numeral table entry number 4: DM 0004 (words: 1)

Screens

Create a number setting screen with the Support Tool to input values into memory tables numbers 3 and 4 and transfer it to the PT. Numbers should be input as 4 digits.

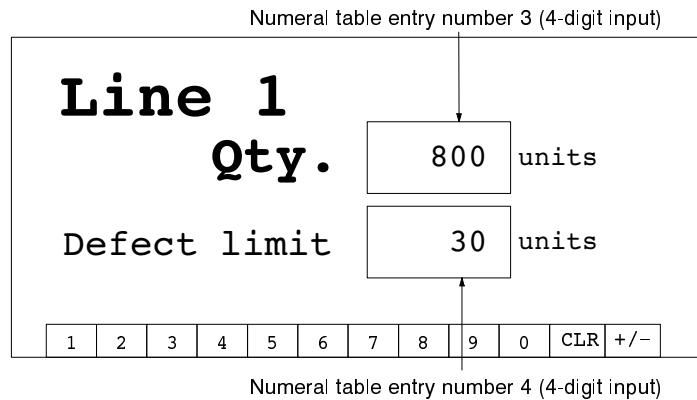

PC Program

Create a PC ladder program, as follows:

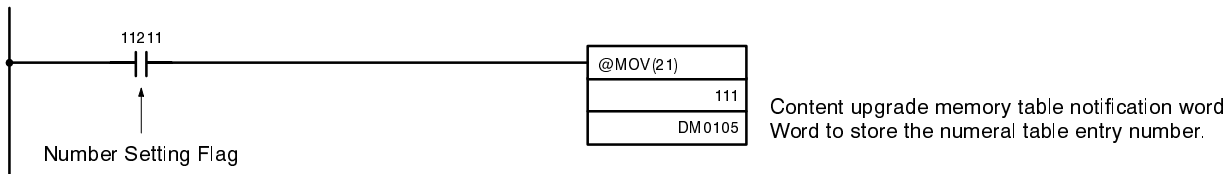

PT operation when the number setting screen is displayed and the program is run as described below.

When the Number Setting Flag (Bit: 11211) turns ON (1) the contents of word 111 are transferred to DM 0105. The number of the numeral table with upgraded contents is stored in DM 0105.

The value input to the numeral table is stored in the word allocated to the numeral table. Numeral table entry number 3 is allocated to DM 0003 and numeral table entry number 4 is allocated to DM 0004.

4-11 Determining PT Operating Status

Description

The PT operating status and the battery level can be determined by reading the PT Status word in the PT Status Notify Area allocated to the PC memory.

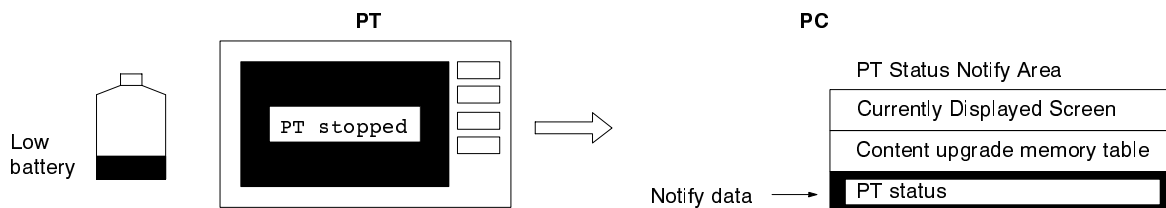

Allocated start address: Word n (set with the Support Tool)

Word	15	14	13	12	11	10	9	8	7	6	5	4	3	2	1	0	Bit
n + 2	PT status											0	0	PT status			

PT Status Notify Bits:

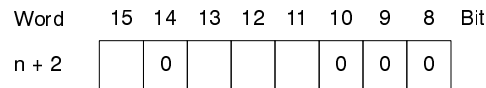

Bit	Notified item	1 (ON)	0 (OFF)
15	PT operating status	Run	Stop
13	Battery	Low	Normal

Bit 12: Screen Switch Flag
 Bit 11: Number Setting Flag

PT Operating Status (Bit 15) This bit is ON (1) when the PT is in Run mode. It is OFF when the PT is not in Run mode and while the System Menu is displayed. Reading and writing the allocated bits and words is disabled when this bit is OFF (0).

Battery (Bit 13) This bit turns ON (1) when the PT internal memory back-up battery is low.

Screen Switch Flag (Bit 12) This bit turns ON (1) when the PT screen display switches due to an instruction from the PC or due to the stand-alone functions. It reverts to OFF (0) when the PC is notified of the screen switch. Refer to 4-9 *Determining the Screen Displayed on the PT* for more details.

Number Setting Flag This bit turns ON (1) when a value is written to a numeral table by the PT number setting function. It reverts to OFF (0) when the PC is notified of the number input. Refer to 4-10 *Determining a Number Input to the PT* for more details.

Restrictions

Allocated Words The PT Status Notify Area can be allocated to the areas listed in the following table.

Symbol	Area	Allocation OK?
DM	Data Memory	OK
I/S	Internal/Special Relay	OK
TIM	Timer	NG
CNT	Counter	NG
HR	Holding Relay	OK
AR	Auxiliary Relay	OK
LR	Link Relay	OK

The range of each memory area differs according to the PC type. Refer to *Appendix B PC Memory Map* for more details.

Procedure

- 1, 2, 3... 1. Use the Support Tool to allocate the PT Status Notify Area to the PC memory.
2. Write a PC program to read the PT Status word from the PT Status Notify Area and check the status of the bits described above.

Important Points

All screen data and other data in the PT is lost when the PT battery becomes flat. Replace the battery with a new one as soon as possible after a low battery voltage is detected. Refer to the appropriate *PT Operation Manual* for details of the battery replacement procedure.

Application Example

This example reads the PT operation status then sounds the buzzer and outputs an alarm if the battery voltage is low.

Allocation

Allocate the memory as follows using the Support Tool:

PT Status Control Area: 0100

PT Status Notify Area: 0110

Screens

Not specified.

PC Program

Create a PC ladder program, as follows:

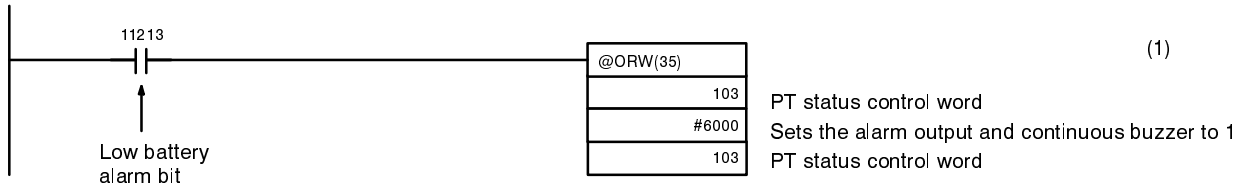

PT operation when the program is run is described below.

If the low-batter notify bit (11213) is ON the following bits in the PT Status Control Area are controlled:

- Alarm output (bit 14): 1 (ON)
- Continuous buzzer (bit 13): ON

The PT continuous buzzer sounds and the alarm output turns ON.

Refer to 4-7 *Controlling the PT Status*.

4-12 Determining Touch Switch Status

Description

A touch switch status (pressed or not) can be determined by checking the ON/OFF status of the notify bit allocated in the PC to the touch switch.

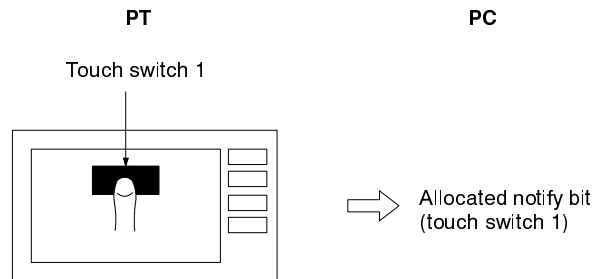

Allocate the notify bits with the Support Tool.

The status of the bit reflects the touch switch status, as follows:

- 0 (OFF): not pressed
- 1 (ON): pressed

Restrictions

Allocated Bits

The PT Status Notify Area can be allocated to the areas listed in the following table.

Symbol	Area	Allocation OK?
DM	Data Memory	OK
I/S	Internal/Special Relay	OK
TIM	Timer	NG
CNT	Counter	NG
HR	Holding Relay	OK
AR	Auxiliary Relay	OK
LR	Link Relay	OK

The range of each memory area differs according to the PC type. Refer to *Appendix B PC Memory Map* for more details.

Procedure

- 1, 2, 3...
1. Use the Support Tool to allocate the touch switch notify bits to the PC memory.
 2. Write a PC program to read and check the allocated notify bits.

Important Point

Be sure to allocate each touch switch on a single screen to different bits.

Reference

Touch switch notification is performed on each bit. In a word allocated with a touch switch notification bit, the touch switch notification bit does not have any influence on any other bit.

The screen attributes are ignored when Direct Connection is used. The attributes are permanently set as a Touch Switch.

In addition to the notification function, the following two other functions can be allocated to touch switches with the Support Tool. When one of these functions is specified, the allocated bits are not notified of the touch switch status.

- a) Screen switch function (stand-alone or screen switch function)
- b) Use as a keypad for number input (number setting function)

Refer to the appropriate *PT Operation Manuals* for details about these functions.

Application

This example uses the touch switches as normal switches for use as a PT operating panel.

Allocation

Allocate the touch switches as follows using the Support Tool:

Touch switch number 10: control bit 05000 (Run lamp), notify bit: 06000

Touch switch number 11: control bit 05001 (Stop lamp), notify bit: 06001

Set the touch switch function to Notify Bit.

Screens

Create a screen which displays touch switches numbers 10 and 11 as shown below and transfer it to the PT. Set the display attribute to "Light".

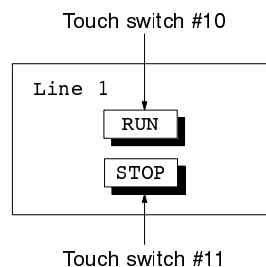

PC Program

Create the following ladder program.

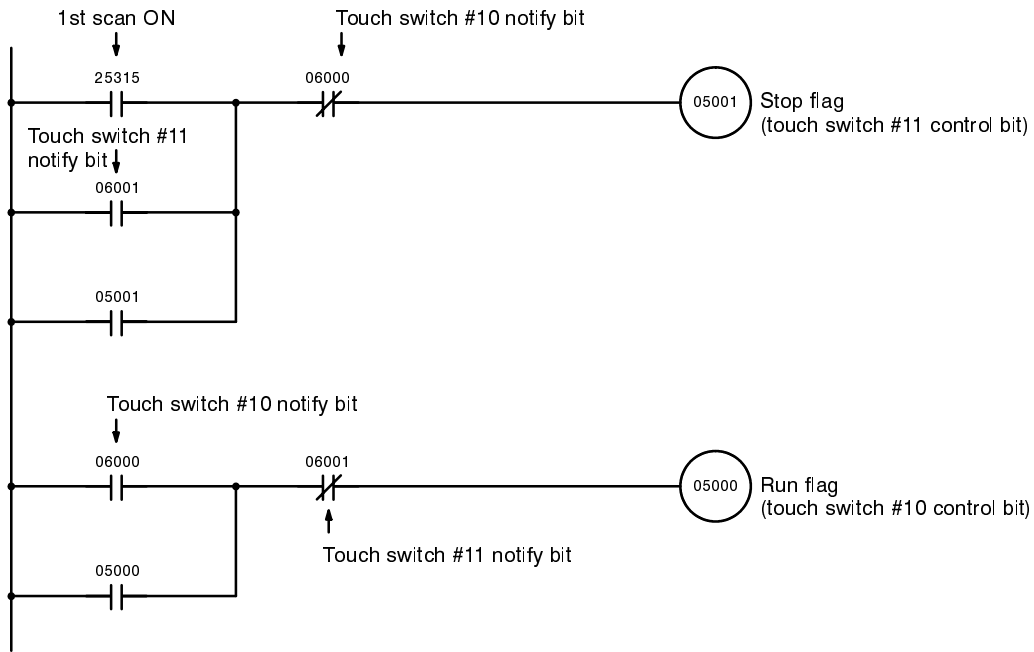

PT operation when the created screen is displayed and the program is run is described below.

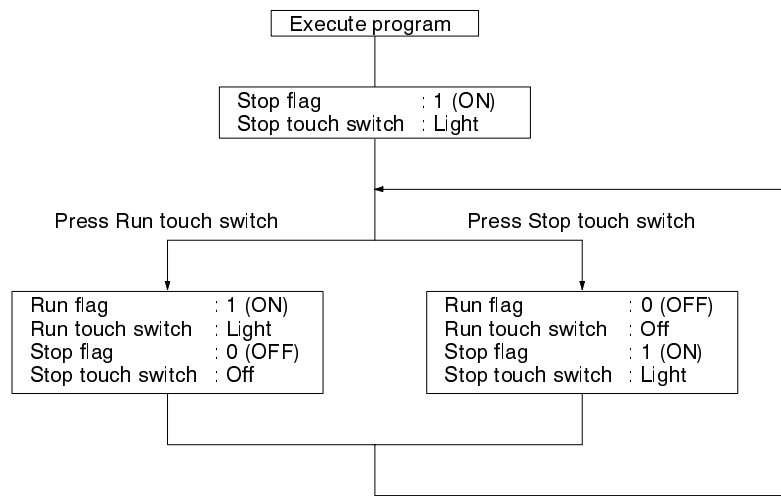

Refer to 4-8 Turning Lamps and Touch Switches On and Off for the method of lighting and turning off touch switches.

SECTION 5

Data Conversion

This section describes how to convert existing screen data for use with Direct Connection and how to convert a PC program written for Direct Connection OFF for use with Direct Connection OMRON.

- 5-1 Summary of Data Conversion 62
 - 5-1-1 Direct Connection Formats 62
 - 5-1-2 Data Conversion Procedure 62
- 5-2 Data Conversion 62
- 5-3 Changing the Allocated Bits and Words for Data Conversion 64
- 5-4 Modifying Programs for Conversion 67
 - 5-4-1 Comparing Conventional and Direct Connection Formats 67
 - 5-4-2 Program Modifications and Setting Areas 69

5-1 Summary of Data Conversion

The new C200H Host Interface Units can handle Direct Connection and conventional C200H Host Interface Unit specification screen data. This section describes the types of Direct Connection format and the procedure to convert existing screen data for use with Direct Connection.

5-1-1 Direct Connection Formats

Direct Connection format is set from the Tool Setting screen on the Support Tool. It can be set in two ways, as follows:

OFF

Direct Connection not used. Conventional C200H Host Interface Unit specification is used. Use this setting to give compatibility between the C200H Host Interface Unit specification and the screen data and PC programs.

OMRON or ON

Enables Direct Connection for the OMRON C-series PCs.

Note “OMRON” is displayed by the NT20M/NT2000M/NT600M Support Tool Version 4.□.

Refer to *2-3 Connection to an OMRON PC* for information on compatible PCs. The “conventional” C200H Host Interface Unit specification refers to a C200H Host Interface Unit using one of the following System ROMs:

NT20M: NT20M-SMR02-E

NT600M: NT600M-SMR02-EV□

Compatibility of Existing Screen Data

Data created with the NT20M/NT600M Support Tool Ver. 3 is compatible with data created with NT20M/NT600M/NT2000M Support Tool Ver. 4.0_ with Direct Connection set OFF.

5-1-2 Data Conversion Procedure

The data conversion procedure is shown below:

- 1, 2, 3...**
1. Convert Data
Read the existing file or screen data and convert to the Direct Connection format set with the Support Tool.
 2. Convert Allocated Bits and Words
Convert the allocated bits and words to match the Direct Connection format.
 3. Modify Programs (Direct Connection OFF to ON or OMRON)
When converting data from Direct Connection OFF to either ON or OMRON, the conventional C200H Host Interface Unit programs can be modified for re-use.

5-2 Data Conversion

The method for converting data between different Direct Connection formats is described below.

Convertible Data

The following data can be converted:

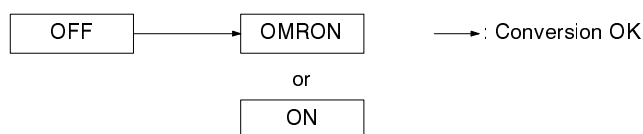

It is not possible to convert data to the Direct Connection OFF format.

How to Covert Data

Data of different Direct Connection formats is converted using the Support Tool. All data in the file is converted.

- 1, 2, 3... 1. Set the Direct Connection format of the data after conversion using "Direct Connection" on the Tool Setting screen of the Support Tool.
2. Select the file to be converted from the File Directory.

Note The contents of the selected file are overwritten. If the contents of the file are needed, use the Copy function to copy the file before converting it.

3. The following prompt is displayed:



4. Press the RETURN KEY to run the data conversion.

Data Communication between the PT and Support Tool

PT to Support Tool (receiving data)

Regardless of the Support Tool settings, data is read from the PT and a file is created in the Direct Connection format set at the PT.

Support Tool to PT (sending data)

Date transmission is not possible if the PT contains data of a different Direct Connection format from the transmitted file. In this case, either transmit data with the same format as the data in the PT or initialize all data in the PT.

Comparing Direct Connection in Units

The Direct Connection format of the C200H Host Interface Unit is the same as that of the Host Interface Unit except for the following, which should be taken into consideration when using the same data for both the C200H Host Link Unit and Host Interface Unit.

- 1, 2, 3... 1. The C200H Host Interface Unit does not incorporate general-purpose memory and also cannot use general-purpose memory. The C200H Host Interface Unit does not exchange data with any PC except by communications with I/O connections, which makes high-speed processing possible.
2. The C200H Host Interface Unit can indirectly specify word allocation, while the Host Interface Unit cannot.
3. The Host Interface Unit can connect to CV- and CVM1-series PCs, while the C200H Host Interface Unit cannot connect.
4. The Host Interface Unit's data transmission path can be extended using RS-422 or optical fiber cable.

Screen data created by the Support Tool can be used by both the C200H Host Interface Unit and Host Interface Unit because there is no difference in Direct Connection format.

5-3 Changing the Allocated Bits and Words for Data Conversion

After data is converted from one Direct Connection format to another, the allocated bits and words are changed as follows:

Items Changed

When data is converted from Direct Connection OFF to Direct Connection OM-RON or ON format, all allocated bits and words revert to an “unallocated” status. Reset the items listed below to match the system and PC program.

PT Status Control Area

Allocated words:

Set the start addresses for the words allocated in the PT Status Control Area.

PT Status Notify Area

Allocated words:

Set the start addresses for the words allocated in the PT Status Notify Area.

Character Strings

Allocated words:

Set the number of words allocated to the character-string memory table (NT20M: 1 to 16 words or NT600M: 1 to 20 words), the start address, initialize/not initialize. Other settings remain unchanged after the conversion.

Numerals

Allocated words:

Set the number of words allocated to the numeral table (1 or 2 words), the start address, initialize/not initialize.

Display method:

Set if the numbers are displayed as a decimal or hexadecimal value. Other settings remain unchanged after the conversion.

Lamps

Allocated control bits:

Set the bit addresses to control the lighting (flashing) of the lamps.

Other settings remain unchanged after the conversion.

Touch Switches

Allocated control bits:

Set the bit addresses to control the lighting (flashing) of the touch switches.

Display attributes:

Set if the touch switch lights continuously or flashes when the control bit turns ON (1).

Notify function:

Set the operation when the touch switch is pressed. If screens are switched using the Stand-alone functions (screen switch function), the setting remains unchanged after conversion.

If the number setting function is used to input numbers from a displayed keypad, the keypad settings must be repeated after data conversion. Set the touch key numbers again.

Allocated notify bits:

Set the bit addresses to notify the PC when each touch switch is pressed.

Other settings remain unchanged after the conversion.

In addition to the items listed above, the words for the numeral table used for bar graph and number settings must be re-allocated.

Allocatable Bits and Words

The following bits and words of the PC memory area can be allocated for OM-
RON PC Direct Connection.

Symbol	Area name	Allocate bit	Allocate word	
			Numeral	Character string
DM	DM Area	OK	OK	OK
IR	IR Area	OK	OK	OK
TIM	Timer Area	NG	1 word only	NG
CNT	Counter Area	NG	1 word only	NG
HR	Holding Area	OK	OK	OK
AR	AR Area	OK	OK	OK
LR	Link Area	OK	OK	OK

The range of each memory area differs according to the PC type. Refer to *Appendix B PC Memory Map* for more details.

Setting Programs for Re-use

The method described below allows a Direct Connection OFF format PC program to be reused with only minor modifications.

The method involves setting up the DM area as shown in the diagram below to match the Direct Connection OFF format bit and word allocation as closely as possible. The setting to initialize the memory table or not should remain unchanged.

5-4 Modifying Programs for Conversion

This section describes the method to modify a program created for a conventional C200H Host Interface Unit (Direct Connection OFF) to use it for Direct Connection.

It is important to understand the differences between the conventional format and Direct Connection format before modifying a program.

The modifications to the program described here are the minimum modifications required. To use the Direct Connection format to most effectively control the PT the programs should be entirely rewritten.

5-4-1 Comparing Conventional and Direct Connection Formats

The differences between the conventional format and Direct Connection format are described below.

Example 1

The memory tables and the bits and words to control and notify the lamp and touch switch status can be allocated almost anywhere in the PC memory. The number of words allocated to a memory table can also be freely allocated (see *Modification and Settings 1*, page 69).

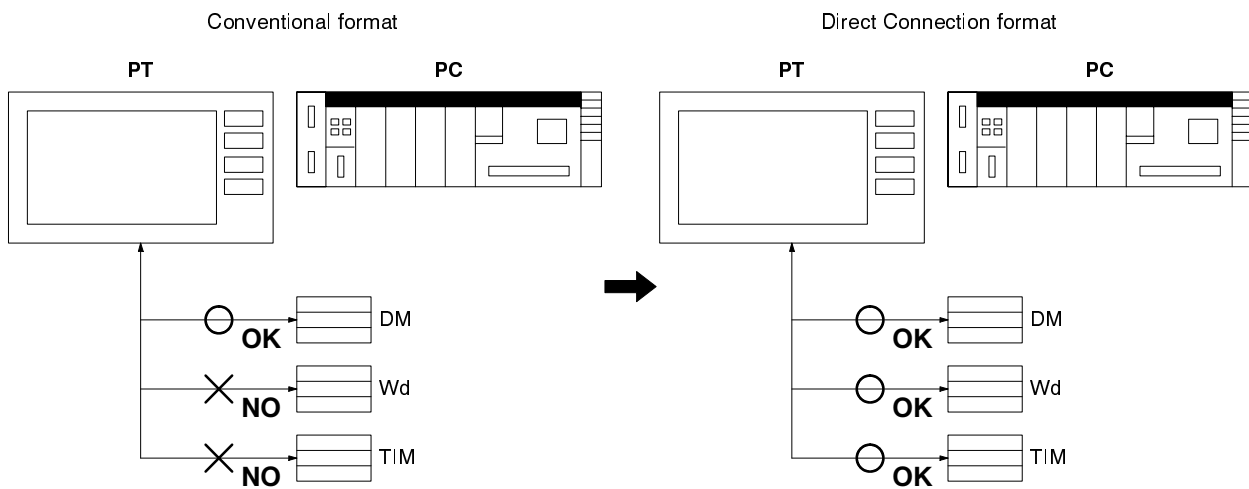

Example 2

No limit on the number of memory tables in the PC memory as memory tables, lamps and touch switches can be independently read or written to the PC memory (see *Modification and Settings 2*, page 69).

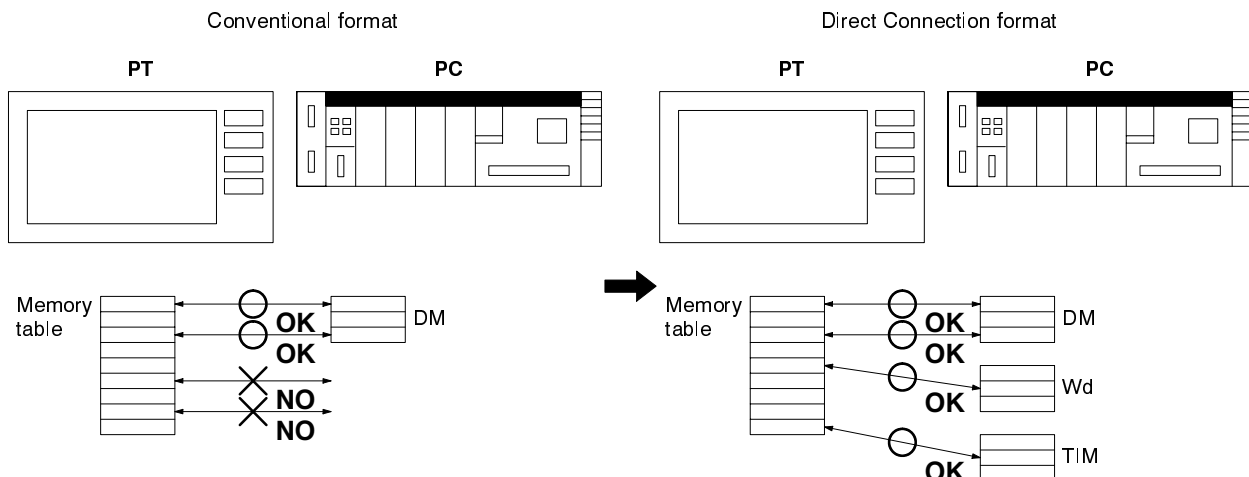

Example 3

All control and notification uses bits instead of lamp and touch switch numbers, so that lamps and touch switches can all be handled by a single process and it is not necessary to change the processing to suit the number (see *Modification and Settings 3*, page 69).

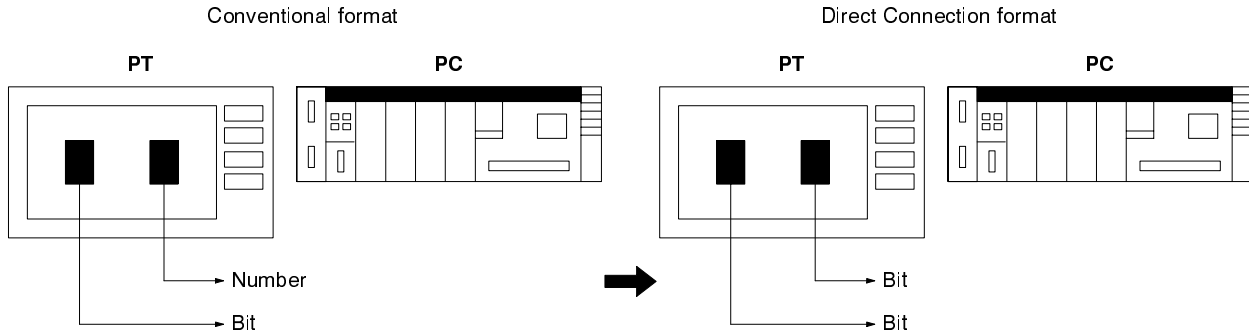

Example 4

The memory table initial values when the PT is booted up can be selected between the values set with the Support Tool and the values in the PC (see *Modification and Settings 4*, page 70).

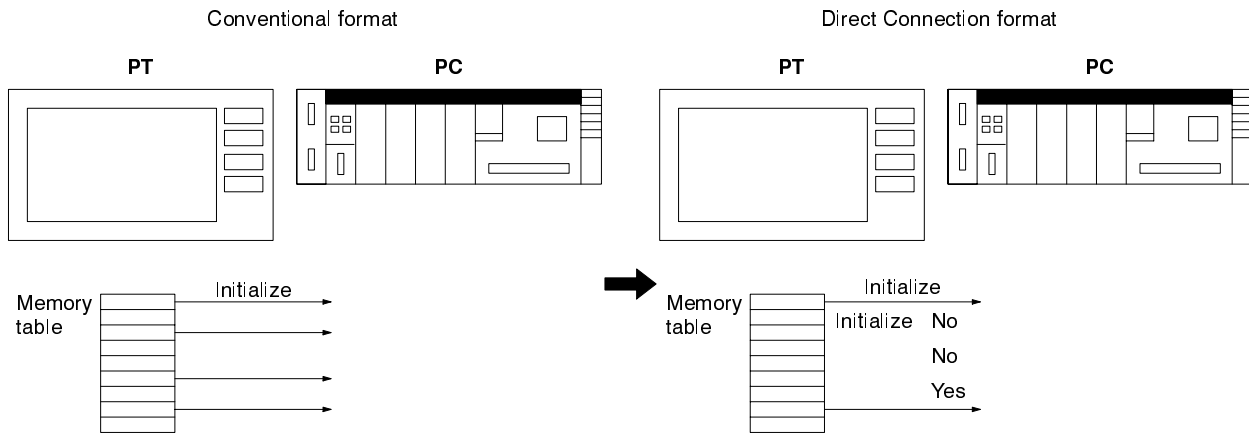

Example 5

The PT control and notification functions have been simplified to use a fixed memory area for each function, thereby eliminating the need for instruction codes and simplifying data preparation and analysis (see *Modification and Settings 5*, page 70).

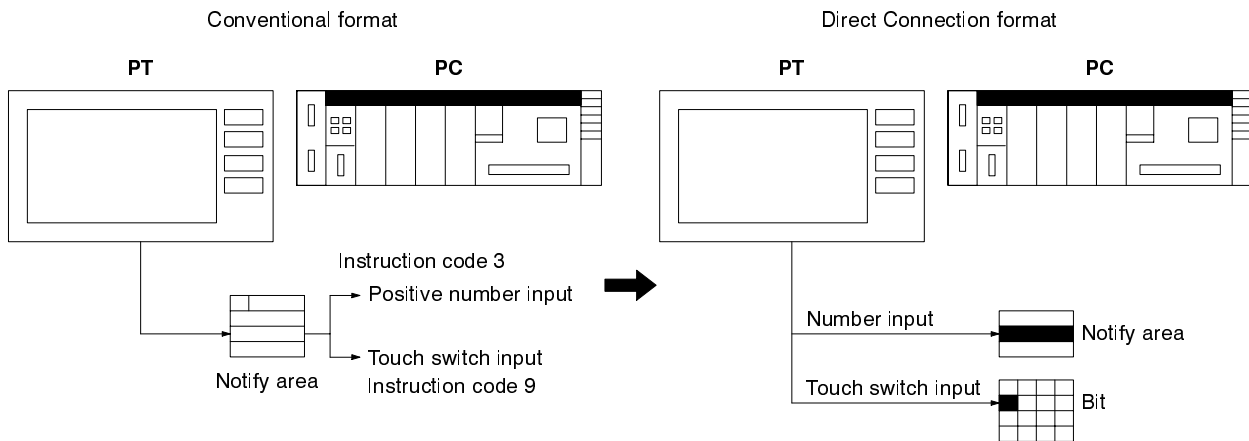

Example 6

Hexadecimal display of number data is possible. The handling of number data has changed such that negative numbers can be expressed as number data. In conventional format, instruction codes were used to differentiate between posi-

tive and negative values and this could not be determined from the number data alone (see *Modification and Settings 6*, page 72).

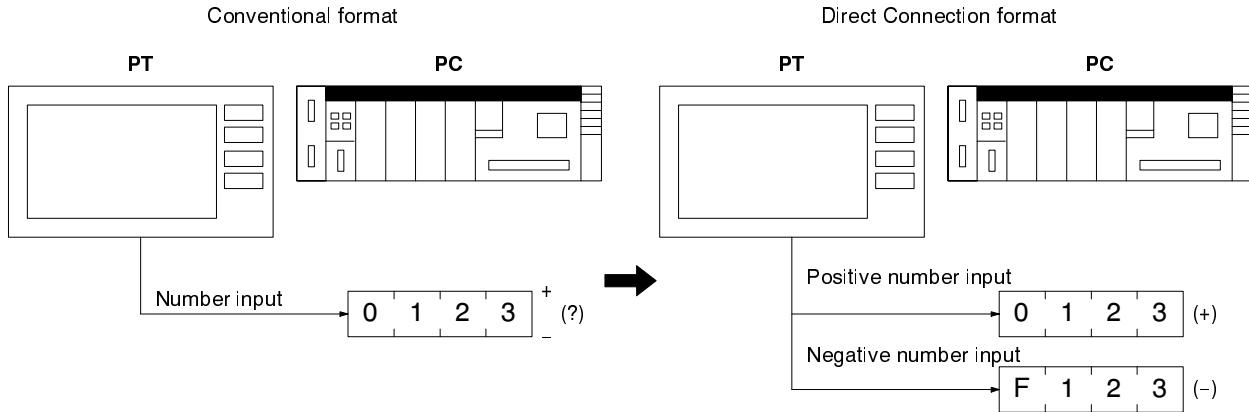

5-4-2 Program Modifications and Setting Areas

If existing programs are re-used, refer to *5-4-1 Comparing Conventional and Direct Connection Formats* for information on program modification and setting memory areas.

This section described how to modify programs. Refer to the following manuals for more information on programs.

- Conventional format programs:
NT-series C200H Host Interface Units Operation Manual
- Direct Connection format programs:
Refer to *Section 3 Direct Connection Operation* and *4 PT Operation*.

- Modification and Settings-1** Allocate the bits and words in the same way as for the conventional format.
- Modification and Settings-2** The number of memory tables allocated to the PC memory should match the C200H Host Interface Unit CIP switch settings in the conventional format.
- Modification and Settings-3** Allocate the same control and notify bits to lamps and touch switch numbers 0 to 63 (or 0 to 111) as were allocated in the conventional format. For lamps and touch switches numbered 64 (or 112) and above, modify the program to allow bit control and notification. Allocate bits for easy handling by the program.

Example: Allocation of lamp #64 to turn the lamp ON when bit 00001 turns ON and to turn it OFF when bit 00002 turns ON.

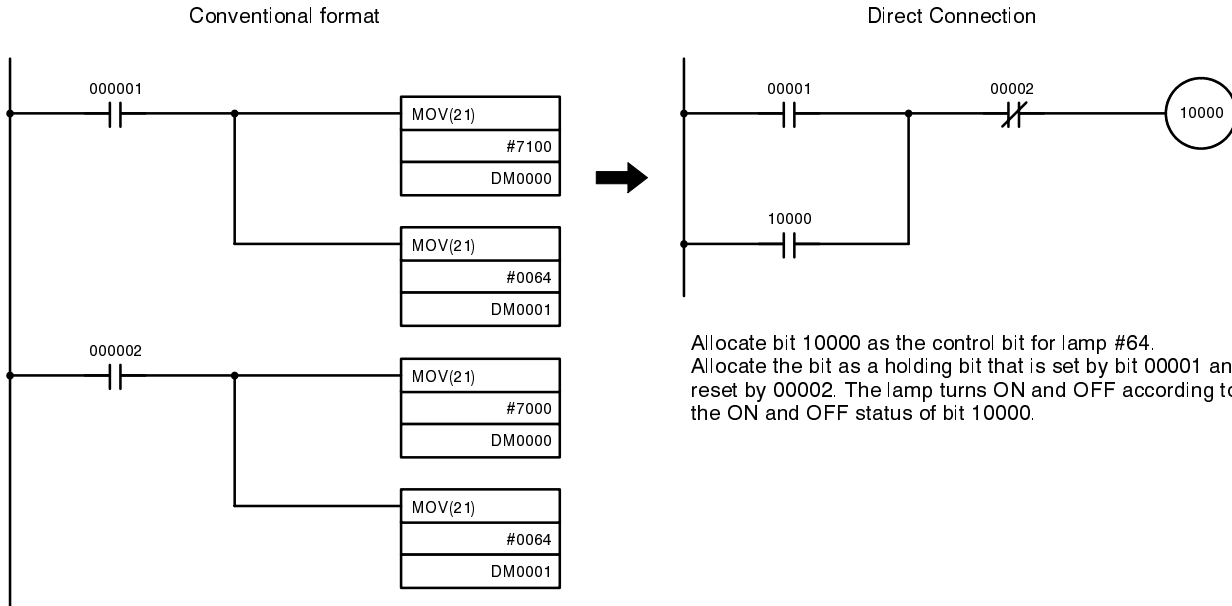

Allocate bit 10000 as the control bit for lamp #64. Allocate the bit as a holding bit that is set by bit 00001 and reset by 00002. The lamp turns ON and OFF according to the ON and OFF status of bit 10000.

When bit 00001 turns ON an instruction lights lamp #64. The lamp turns OFF when bit 00002 turns ON.

- Modification and Settings-4** Set with the DIP switches or Support Tool whether or not the PC memory is initialized with the values set by the Support Tool. This setting must match the C200H Host Interface Unit DIP switch settings in the conventional format. Refer to *2-1 Components and Settings* for information on the DIP switch settings.
- Modification and Settings-5** Modify parts of the program using instruction codes to conduct the same processing with no instruction codes.

Example: To read numbers input with the PT number setting function to numeral table entry number 4.

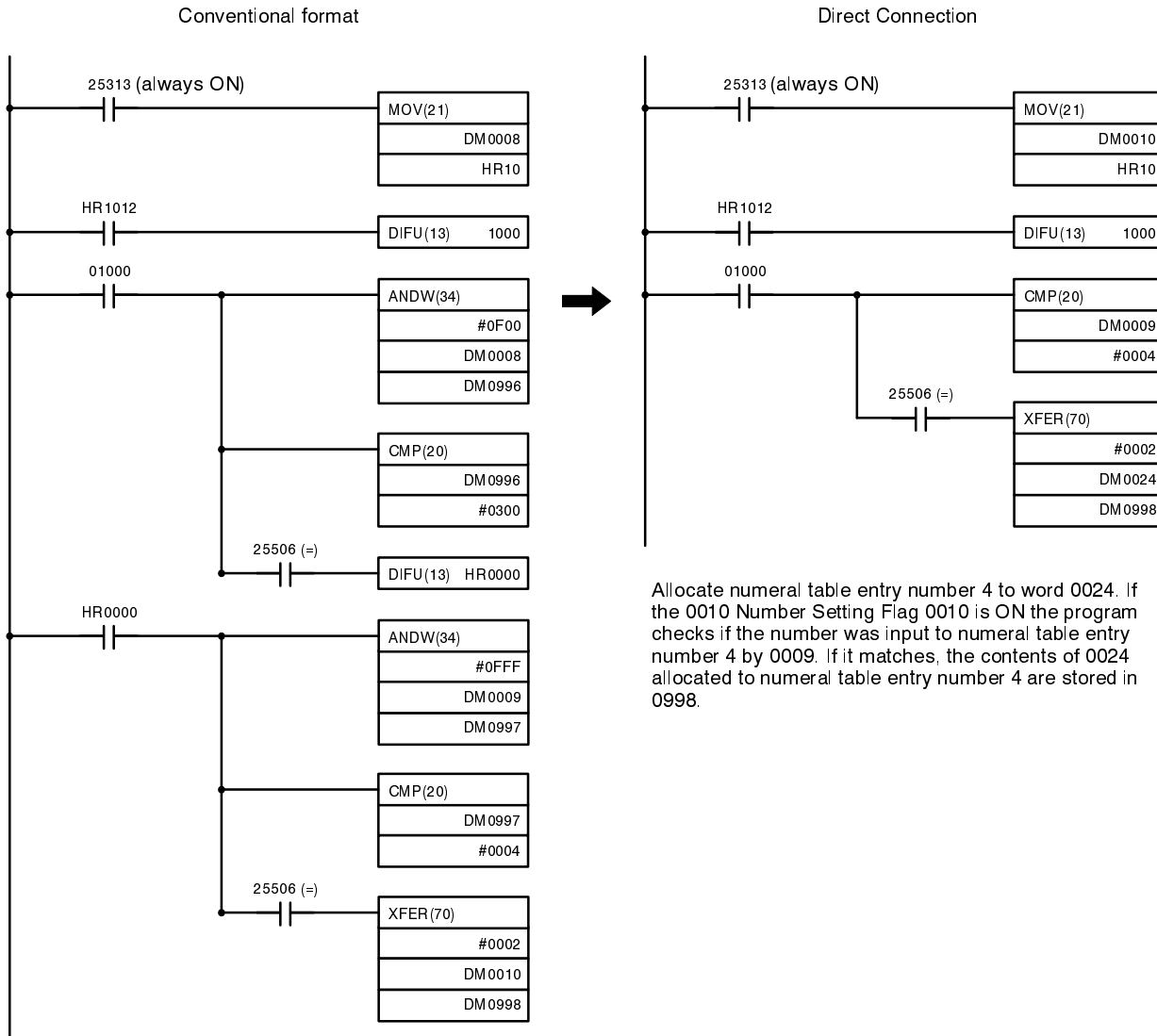

Allocate numeral table entry number 4 to word 0024. If the 0010 Number Setting Flag 0010 is ON the program checks if the number was input to numeral table entry number 4 by 0009. If it matches, the contents of 0024 allocated to numeral table entry number 4 are stored in 0998.

Bit 12 of DM0008 is the flag for data written from the PT. When this flag bit turns ON the program checks if the DM0008 instruction code is code 3 (positive number input). If a positive number is input the program verifies it against DM0009 to determine if it is numeral table entry number 4. If it matches the notified number is stored in word 0010 and 0011.

In this example, the PT Status Notify Area is allocated to the DM Area and the status of the Number Setting Flags is checked using HR bits and work bits. When writing a program for Direct Connection use, initially allocating the PT Status Notify Area to work bits allows the Number Setting Flag bits to be used directly as the input bits.

Modification and Settings-6 Modify the program such that number representation matches the number representation of the Direct Connection format. Refer to *4-4 Editing Displayed Numerals and Character Strings*.

Example: Writing the value -1234567 to numeral table entry number 2 when bit 00001 turns ON.

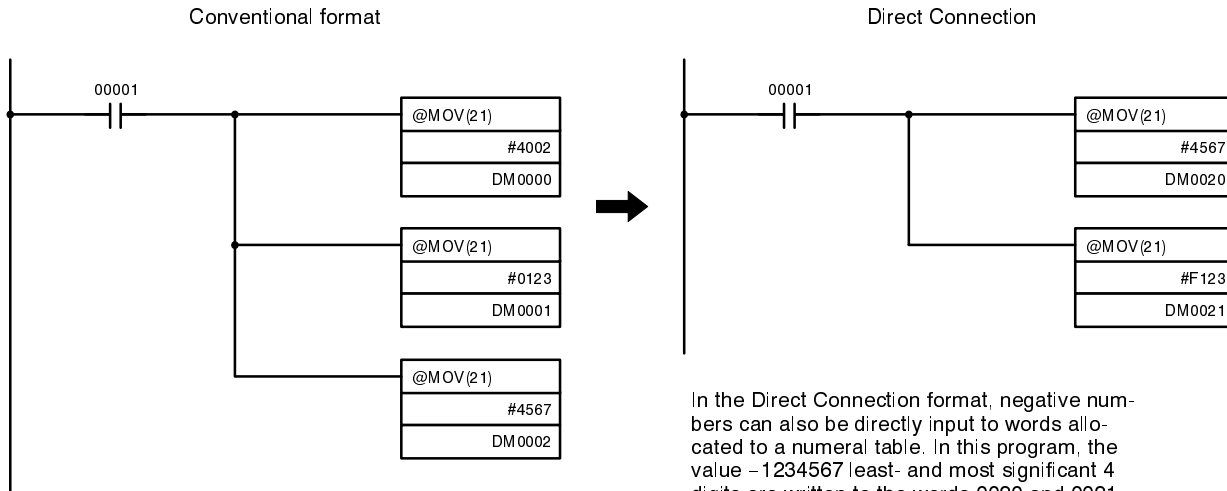

In the Direct Connection format, negative numbers can also be directly input to words allocated to a numeral table. In this program, the value -1234567 least- and most significant 4 digits are written to the words 0020 and 0021 allocated numeral table entry number 2.

If numeral table is allocated to memory, a negative number cannot be directly written to it in the conventional format. Instruction code 4 (negative number input) is used to write -1234567 as the most- and least-significant 4 digits to numeral table entry number 2.

Note The order of the words storing the most-significant 4 digits and least-significant 4 digits is opposite in the conventional format to the Direct Connection format.

SECTION 6

Troubleshooting

This section describes the procedures to follow if the PT does not operate correctly.

6-1	Errors Occurring when the Power is Turned ON	74
6-2	Errors Occurring During Operation	74
6-3	Communication Errors	75

6-1 Errors Occurring when the Power is Turned ON

Refer to the table below for the causes and remedies for errors occurring when the PT power is turned on.

Message	Cause	Remedy
No Host Interface Unit	Host Interface Unit not installed. The System ROM is not compatible with the Host Interface Unit.	Install the Host Interface Unit. Determine the System ROM compatible with the Host Interface Unit and mount the correct type of ROM.
Unformatted memory	Screen data memory board not installed. EEPROM or EPROM not mounted correctly on the the screen data memory board. The screen memory board DIP switch settings do not match the specifications of the memory chip.	Correctly install the screen data memory board. Correctly mount the memory chip on the screen memory board. Correctly set the screen memory board DIP switches.
Screen data destroyed	The screen data is not compatible with the System ROM. The power supply was turned off during transmission of the screen data.	Create the correct screen data with the Support Tool. Transfer the screen data once more with the Support Tool.
Mark data destroyed	The power supply was turned off during transmission of the screen data.	Transfer the screen data once more with the Support Tool.
Host error	If the PT DIP switches are set to enable Host RUN input: The PC power supply is not turned on. The Host RUN input signal voltage is low.	Turn on the PC power supply. Apply the voltage to the Host RUN input.
No Direct information set Set the PT Status Control Area and PT Status Notify Area with the Support Tool.	The PT Status Control Area and PT Status Notify Area are not allocated to memory.	Allocate the PT Status Control Area and PT Status Notify Area to memory with the Support Tool.
Unit error occurred	The C200H Host Interface Unit has an error.	Consult your OMRON representative.

6-2 Errors Occurring During Operation

Refer to the table below for the causes and remedies for errors occurring during PT operation.

Message	Cause	Remedy
Host error	If the PT DIP switches are set to enable Host RUN input: The PC power supply is turned off while the PT is operating. The Host RUN input signal voltage is low.	Check the PC power supply and operating status.
Setting error Simultaneous display of memory type and address.	Bits or words allocated with the Support Tool in the PC memory not found.	Check the memory in the PC used and correct the bit and word allocation.

Status	Cause	Remedy
The memory table setting screen is displayed and the initial screen does not appear. No error message is displayed on the PT or the buzzer does not go off.	The PC has an error.	Check the error by monitoring and restore the condition. Refer to <i>Section 7 Program Monitoring and Execution of the C200H Operation Manual (CPU21-E, etc.) (W217)</i> or of the <i>C200H Operation Manual (CPU01-E, etc.) (W130)</i> for details.
The initial screen is displayed and the screen is locked. No error message is displayed on the PT or the buzzer does not go off.		

6-3 Communication Errors

The remedies for communication errors occurring during operation are described below.

Communication Error Message

A message is displayed on the PT and a buzzer sounds when a communication error occurs. Error messages are displayed if automatic reset after communication error is disabled with the DIP switches.

Procedure

When the buzzer sounds, press the BUZZER or RETURN key to revert the screen display to the operation display.

Error Display

Communication errors are displayed as follows:

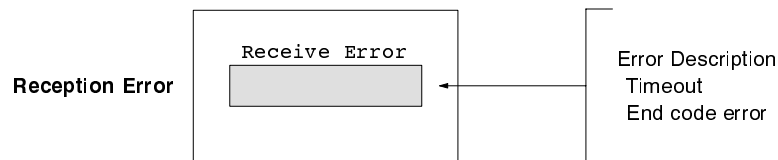

Message	Cause	Remedy
Timeout	Cable connector is disconnected. PC is halted.	Reconnect the cable. Make sure the PC is able to communicate with the PT.
End code error	The PT or the C200H Host Interface Unit has an error	Consult your OMRON representative.

Appendix A

PC Memory Map

OMRON C Series Memory Map

PC	IR Area	HR Area	AR Area	Link Relay Area	Timer/Counter Area	DM Area
C20H	0000 to 0255	0000 to 0099	0000 to 0027	0000 to 0063	0000 to 0511	0000 to 1999
C28H						
C40H						
C60H						
C200H	0000 to 0255	0000 to 0099	0000 to 0027	0000 to 0063	0000 to 0511	0000 to 1999

Note Do not exceed the above ranges when allocating words.

Appendix B

Product Information

C200H Host Interface Unit

Name	Model
C200H Host Interface Unit	NT600M-LB122

PT

Name	Model	Programmable Terminal
Programmable Terminal	NT20M-DT131	Touch-panel version (replaceable backlight model)
	NT20M-DT121-V2	Touch-panel version (monochrome LCD model)
	NT600M-DT122	Touch-panel version (monochrome LCD model)
	NT600M-DT211	Touch-panel version (EL display model)

CPU

Name	Model
C20H	C20H-C□DR-DE-V1 C20H-C□DT-DE-V1
C28H	C28H-C□DR-DE-V1 C28H-C□DT-DE-V1
C40H	C40H-C□DR-DE-V1 C40H-C□DT-DE-V1
C60H	C60H-C□DR-DE-V1 C60H-C□DT-DE-V1
C200H	C200H-CPU□□-E

Related Parts and Equipment for PT

Name		Model	Comments
System ROM		NT20M-SMR32-E NT600M-SMR32-E	NT20M, NT600M
Screen memory board	IC socket type S-RAM 64KB S-RAM 128KB S-RAM 256KB	NT600M-MP251 NT600M-MR641 NT600M-MR151 NT600M-MR251	NT600M
Screen memory	S-RAM 64KB S-RAM 128KB EPROM 64KB EPROM 128KB EEPROM 32KB	RAM22-15 RAM13-10 ROM-KD-B ROM13-12B EER22-20	NT20M
	EPROM 64KB EPROM 128KB EPROM 256KB EEPROM 32KB	ROM-KD-B ROM13-12B ROM23-15B EER22-20	for NT600M IC socket type
Support Tool		NT20M-ZASAT-EV4	3.5-inch (2DD) and 5.25-inch (2HD) disks

Parts and Equipment for Connections

I/O Connecting Cable

Connecting PC	Model	Cable length
C200H	C200H-CN311	30 cm
	NT20M-CNP711 C200H-CN711	70 cm
	NT20M-CNP221 C200H-CN221	2 m
	NT20M-CNP521 C200H-CN521	5 m
	NT20M-CNP131 C200H-CN131	10 m
	C□□H	C200H-CN312
NT20M-CNP712 C20H-CN712		70 cm
NT20M-CNP222 C20H-CN222		2 m

Revision History

A manual revision code appears as a suffix to the catalog number on the front cover of the manual.

Cat. No. V018-E1-1

↑
— Revision code

The following table outlines the changes made to the manual during each revision. Page numbers refer to the previous version.

Revision code	Date	Revised content
1	December 1993	Original production