

CP1L

CPU Units and Expansion Units

When it comes to controllers for compact machines, Omron's new CP1L series offers the compactness of a micro-PLC with the capability of a modular PLC.

But this new and exciting range is not only compact, it is scaleable, has a faster processing speed than other controllers and is in a class of its own when it comes to price/performance. Naturally, it is compatible with all other devices in the Omron PLC line up.

- 4 high-speed encoder inputs and 2 high-speed pulse outputs
- CPUs with AC or DC supply and 14, 20, 30 or 40 I/O built-in
- Instruction set compatible with CP1H-, CJ1-, and CS1 series PLC
- Optional RS232C and RS-422A/485 serial ports
- USB programming port
- Scaleable with a wide range of I/O units (maximum up to 160 I/O points)
- Motion functionality
- One and the same software as other Omron controllers



CPU Unit Specification

Item	Type Model	AC power supply models CP1L-□□□-A	DC power supply models CP1L-□□□-D
Power supply		100 to 240 VAC 50/60 Hz	24 VDC
Operating voltage range		85 to 264 VAC	20.4 to 26.4 VDC
Power consumption		50 VA max. (CP1L-M40/M30DR-A) (See next page.) 30 VA max. (CP1L-L20/L14DR-A)	20 W max. (CP1L-M40/M30□□-D) (See next page.) 13 W max. (CP1L-L20/L14□□-D)
Inrush current (See note.)		100 to 120 VAC inputs: 20 A max. (for cold start at room temperature) 8 ms max. 200 to 240 VAC inputs: 40 A max. (for cold start at room temperature), 8 ms max.	30 A max. (for cold start at room temperature) 20 ms max.
External power supply		300 mA at 24 VDC (CP1L-M30/M40) 200 mA at 24 VDC (CP1L-L14/L20)	None
Insulation resistance		20 MΩ min. (at 500 VDC) between the external AC terminals and GR terminals	No insulation between primary and secondary for DC power supply
Dielectric strength		2,300 VAC at 50/60 Hz for 1 min between the external AC and GR terminals, leakage current: 5 mA max.	No insulation between primary and secondary for DC power supply
Noise immunity		Conforms to IEC 61000-4-4. 2 kV (power supply line)	
Vibration resistance		Conforms to JIS C0040. 10 to 57 Hz, 0.075-mm amplitude, 57 to 150 Hz, acceleration: 9.8 m/s ² in X, Y, and Z directions for 80 minutes each. Sweep time: 8 minutes x 10 sweeps = total time of 80 minutes)	
Shock resistance		Conforms to JIS C0041. 147 m/s ² three times each in X, Y, and Z directions	
Ambient operating temperature		0 to 55°C	
Ambient humidity		10% to 90% (with no condensation)	
Ambient operating environment		No corrosive gas	
Ambient storage temperature		-20 to 75°C (Excluding battery.)	
Power holding time		10 ms min.	2 ms min.

Note: The above values are for a cold start at room temperature for an AC power supply, and for a cold start for a DC power supply.

- A thermistor (with low-temperature current suppression characteristics) is used in the inrush current control circuitry for the AC power supply. The thermistor will not be sufficiently cooled if the ambient temperature is high or if a hot start is performed when the power supply has been OFF for only a short time. In those cases the inrush current values may be higher (as much as two times higher) than those shown above. Always allow for this when selecting fuses and breakers for external circuits.
- A capacitor charge-type delay circuit is used in the inrush current control circuitry for the DC power supply. The capacitor will not be charged if a hot start is performed when the power supply has been OFF for only a short time, so in those cases the inrush current values may be higher (as much as two times higher) than those shown above.

Current Consumption

The power consumption shown on page 1 is the maximum power consumption. To obtain the correct power consumption for the system configuration, calculate the power consumption for the external power supply from the current consumption given below for the CPU Unit, Expansion Units, and Expansion I/O Units.

CPU Units

Model	Current consumption		External power supply
	5 VDC	24 VDC	24 VDC
CP1L-M40DR-A	0.22 A	0.08 A	0.3 A max.
CP1L-M40DR-D	0.22 A	0.08 A	---
CP1L-M40DT-D	0.31 A	0.03 A	---
CP1L-M40DT1-D	0.31 A	0.03 A	---
CP1L-M30DR-A	0.21 A	0.07 A	0.3 A max.
CP1L-M30DR-D	0.21 A	0.07 A	---
CP1L-M30DT-D	0.28 A	0.03 A	---
CP1L-M30DT1-D	0.28 A	0.03 A	---
CP1L-L20DR-A	0.20 A	0.05 A	0.2 A max.
CP1L-L20DR-D	0.20 A	0.05 A	---
CP1L-L20DT-D	0.24 A	0.03 A	---
CP1L-L20DT1-D	0.24 A	0.03 A	---
CP1L-L14DR-A	0.18 A	0.04 A	0.2 A max.
CP1L-L14DR-D	0.18 A	0.04 A	---
CP1L-L14DT-D	0.21 A	0.03 A	---
CP1L-L14DT1-D	0.21 A	0.03 A	---

- Note 1.** The current consumption of the CP1W-ME05M Memory Cassette and the CP1W-CIF01/CIF11 Option Boards are included in the current consumption of the CPU Unit.
- 2.** CPU Units with DC power do not provide an external power supply.
- 3.** The current consumptions given in the following table must be added to the current consumption of the CPU Unit if an Expansion Unit or Expansion I/O Unit is connected.
- 4.** The external power supply cannot be used if an Expansion Unit or Expansion I/O Unit is connected to a CPU Unit with 14 or 20 I/O points.

Expansion Units and Expansion I/O Units

Unit name	Model	Current consumption		
		5 VDC	24 VDC	
Expansion I/O Units	40 I/O points 24 inputs 16 outputs	CP1W-40EDR	0.080 A	0.090 A
		CP1W-40EDT	0.160 A	---
		CP1W-40EDT1		
	20 I/O points 12 inputs 8 outputs	CP1W-20EDR1	0.103 A	0.044 A
		CP1W-20EDT	0.130 A	---
		CP1W-20EDT1		
	16 outputs	CP1W-16ER	0.042 A	0.090 A
	8 inputs	CP1W-8ED	0.018 A	---
	8 outputs	CP1W-8ER	0.026 A	0.044 A
		CP1W-8ET	0.075 A	---
	CP1W-8ET1			
Analog Input Unit	4 inputs	CP1W-AD041	0.080 A	0.120 A
Analog Output Unit	4 outputs	CP1W-DA041	0.080 A	0.120 A
	2 outputs	CP1W-DA021	0.095 A	0.040 A
Analog I/O Unit	2 inputs and 1 output	CP1W-MAD11	0.083 A	0.110 A
Temperature Sensor Units	K or J thermocouple inputs	CP1W-TS001	0.040 A	0.059 A
		CP1W-TS002		
	Pt or JPt platinum resistance thermometer inputs	CP1W-TS101	0.054 A	0.073 A
		CP1W-TS102		
CompoBus/S I/O Link Unit	8 inputs and 8 outputs	CP1W-SRT21	0.029 A	---

CPU Units

Type	CP1L-M40 (40 points)	CP1L-M30 (30 points)	CP1L-L20 (20 points)	CP1L-L14 (14 points)	
Item	Models	CP1L-M40□□-□	CP1L-M30□□-□	CP1L-L20□□-□	CP1L-L14□□-□
Control method	Stored program method				
I/O control method	Cyclic scan with immediate refreshing				
Program language	Ladder diagram				
Function blocks	Maximum number of function block definitions: 128 Maximum number of instances: 256 Languages usable in function block definitions: Ladder diagrams, structured text (ST)				
Instruction length	1 to 7 steps per instruction				
Instructions	Approx. 500 (function codes: 3 digits)				
Instruction execution time	Basic instructions: 0.55 μs min. Special instructions: 4.1 μs min.				
Common processing time	0.4 ms				
Program capacity	10K steps		5K steps		
Number of tasks	288 (32 cyclic tasks and 256 interrupt tasks)				
Scheduled interrupt tasks	1 (interrupt task No. 2, fixed)				
	Input interrupt tasks	6 (interrupt task No. 140 to 145, fixed)		4 (interrupt task No. 140 to 143, fixed)	
(Interrupt tasks can also be specified and executed for high-speed counter interrupts and executed.)					
Maximum subroutine number	256				
Maximum jump number	256				
I/O areas	Input bits	24: CIO 0.00 to CIO 0.11 and CIO 1.00 to CIO 1.11	18: CIO 0.00 to CIO 0.11 and CIO 1.00 to CIO 1.05	12: CIO 0.00 to CIO 0.11	8: CIO 0.00 to CIO 0.07
	Output bits	16: CIO 100.00 to CIO 100.07 and CIO 101.00 to CIO 101.07	12: CIO 100.00 to CIO 100.07 and CIO 101.00 to CIO 101.03	8: CIO 100.00 to CIO 100.07	6: CIO 100.00 to CIO 100.05
	1:1 Link Area	1,024 bits (64 words): CIO 3000.00 to CIO 3063.15 (CIO 3000 to CIO 3063)			
	Serial PLC Link Area	1,440 bits (90 words): CIO 3100.00 to CIO 3189.15 (CIO 3100 to CIO 3189)			
Work bits	8,192 bits (512 words): W000.00 to W511.15 (W0 to W511) CIO Area: 37,504 bits (2,344 words): CIO 3800.00 to CIO 6143.15 (CIO 3800 to CIO 6143)				
TR Area	16 bits: TR0 to TR15				
Holding Area	8,192 bits (512 words): H0.00 to H511.15 (H0 to H511)				
AR Area	Read-only (Write-prohibited): 7168 bits (448 words): A0.00 to A447.15 (A0 to A447) Read/Write: 8192 bits (512 words): A448.00 to A959.15 (A448 to A959)				
Timers	4,096 bits: T0 to T4095				
Counters	4,096 bits: C0 to C4095				
DM Area	32 Kwords: D0 to D32767		10 Kwords: D0 to D9999, D32000 to D32767		
Data Register Area	16 registers (16 bits): DR0 to DR15				
Index Register Area	16 registers (32 bits): IR0 to IR15				
Task Flag Area	32 flags (32 bits): TK0000 to TK0031				
Trace Memory	4,000 words (500 samples for the trace data maximum of 31 bits and 6 words.)				
Memory Cassette	A special Memory Cassette (CP1W-ME05M) can be mounted. Note: Can be used for program backups and auto-booting.				
Clock function	Supported. Accuracy (monthly deviation): -4.5 min to -0.5 min (ambient temperature: 55°C), -2.0 min to +2.0 min (ambient temperature: 25°C), -2.5 min to +1.5 min (ambient temperature: 0°C)				
Communications functions	One built-in peripheral port (USB 1.1): For connecting Support Software only.				
	A maximum of two Serial Communications Option Boards can be mounted.		A maximum of one Serial Communications Option Board can be mounted.		
Memory backup	Flash memory: User programs, parameters (such as the PLC Setup), comment data, and the entire DM Area can be saved to flash memory as initial values. Battery backup: The Holding Area, DM Area, and counter values (flags, PV) are backed up by a battery.				
Battery service life	5 years at 25°C. (Use the replacement battery within two years of manufacture.)				
Built-in input terminals	40 (24 inputs, 16 outputs)	30 (18 inputs, 12 outputs)	20 (12 inputs, 8 outputs)	14 (8 inputs, 6 outputs)	
Number of connectable Expansion Units and Expansion I/O Units	CP-series Expansion Unit and Expansion I/O Units: 3 max.		CP-series Expansion Units and Expansion I/O Units: 1 max.		
Max. number of I/O points	160 (40 built in + 40 per Expansion (I/O) Unit × 3 Units)	150 (30 built in + 40 per Expansion (I/O) Unit × 3 Units)	60 (20 built in + 40 per Expansion (I/O) Unit × 1 Unit)	54 (14 built in + 40 per Expansion (I/O) Unit × 1 Unit)	
Interrupt inputs	6 inputs (Response time: 0.3 ms)			4 inputs (Response time: 0.3 ms)	
Interrupt inputs counter mode	6 inputs (Response frequency: 5 kHz max. for all interrupt inputs), 16 bits Up or down counters			4 inputs (Response frequency: 5 kHz max. for all interrupt inputs), 16 bits Up or down counters	
Quick-response inputs	6 points (Min. input pulse width: 50 μs max.)			4 points (Min. input pulse width: 50 μs max.)	
Scheduled interrupts	1				
High-speed counters	4 counters, 2 axes (24-VDC input) 4 inputs: Differential phases (4x), 50 kHz or Single-phase (pulse plus direction, up/down, increment), 100 kHz Value range: 32 bits, Linear mode or ring mode Interrupts: Target value comparison or range comparison				
Pulse outputs (models with transistor outputs only)	Pulse outputs	Trapezoidal or S-curve acceleration and deceleration (Duty ratio: 50% fixed) 2 outputs, 1 Hz to 100 kHz (CCW/CW or pulse plus direction)			
	PWM outputs	Duty ratio: 0.0% to 100.0% (specified in increments of 0.1% or 1%) 2 outputs, 0.1 to 6553.5 Hz or 1 to 32,800 Hz (Accuracy: ±5% at 1 kHz)			
Analog control	1 (Setting range: 0 to 255)				
External analog input	1 input (Resolution: 1/256, Input range: 0 to 10 V). Not isolated.				

Input Terminal Block Arrangement (Top Block)

CP1L-M40

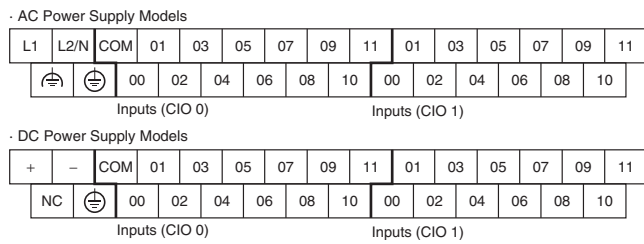

CP1L-L20

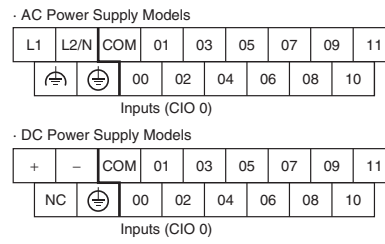

CP1L-M30

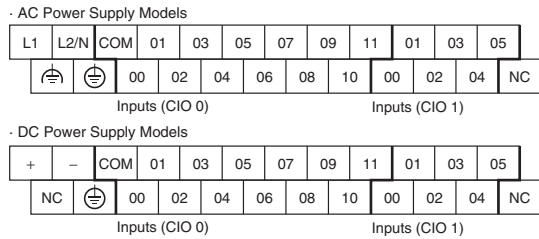

CP1L-L14

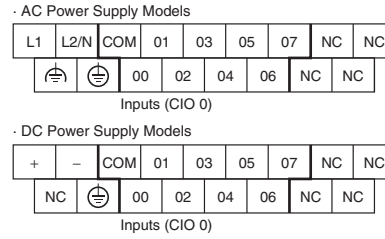

Built-in Input Area

CPU Units

Number of inputs	Input terminal block		Input operation			High-speed counter operation		Origin search		
	Word	Bit	Normal inputs	Interrupt inputs	Quick-response inputs	Operation settings • High-speed counters enabled • Phase-Z signal reset	Single-phase (increment pulse input)	Two-phase (differential phase x4, up/down, or pulse plus direction)	Origin searches enabled for pulse outputs 0 and 1	
14	CIO 0	00	Normal input 0	---	---	---	High-speed counter 0 (increment)	High-speed counter 0 (phase-A, increment, or count input)	---	
		01	Normal input 1	---	---	---	High-speed counter 1 (increment)	High-speed counter 0 (phase-B, decrement, or count input)	---	
		02	Normal input 2	---	---	---	High-speed counter 2 (increment)	High-speed counter 1 (phase-A, increment, or count input)	Pulse output 0: Origin proximity input signal (See note 1.)	
		03	Normal input 3	---	---	---	High-speed counter 3 (increment)	High-speed counter 1 (phase-B, decrement, or count input)	Pulse output 01 Origin proximity input signal (See note 1.)	
		04	Normal input 4	Interrupt input 0	Quick-response input 0	Counter 0, phase-Z/reset input	High-speed counter 0 (phase-Z/reset)	---		
		05	Normal input 5	Interrupt input 1	Quick-response input 1	Counter 1, phase-Z/reset input	High-speed counter 1 (phase-Z/reset)	---		
		06	Normal input 6	Interrupt input 2	Quick-response input 2	Counter 2, phase-Z/reset input		Pulse output 0: Origin input signal		
		07	Normal input 7	Interrupt input 3	Quick-response input 3	Counter 3, phase-Z/reset input		Pulse output 1: Origin input signal		
		20	CIO 0	08	Normal input 8	Interrupt input 4	Quick-response input 4	---		---
				09	Normal input 9	Interrupt input 5	Quick-response input 5	---		---
				10	Normal input 10	---	---	---		Pulse output 0: Origin proximity input signal (See note 2.)
11	Normal input 11			---	---	---		Pulse output 1: Origin proximity input signal (See note 2.)		
30	CIO 1	00	Normal input 12	---	---	---		---		
		01	Normal input 13	---	---	---		---		
		02	Normal input 14	---	---	---		---		
		03	Normal input 15	---	---	---		---		
		04	Normal input 16	---	---	---		---		
		05	Normal input 17	---	---	---		---		
40	CIO 1	06	Normal input 18	---	---	---		---		
		07	Normal input 19	---	---	---		---		
		08	Normal input 20	---	---	---		---		
		09	Normal input 21	---	---	---		---		
		10	Normal input 22	---	---	---		---		
		11	Normal input 23	---	---	---		---		

Note 1. The origin proximity input signals for CPU Units with 14 points are bits 02 and 03 of CIO 0.
 2. The origin proximity input signals for CPU Units with 20 points are bits 10 and 11 of CIO 0.

Output Terminal Block Arrangement (Bottom Block)

CP1L-M40

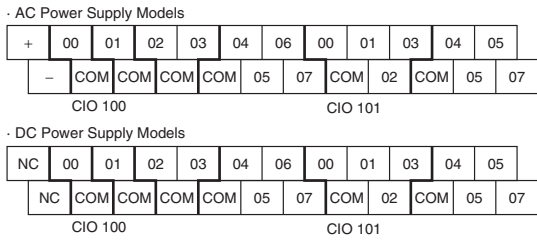

CP1L-L20

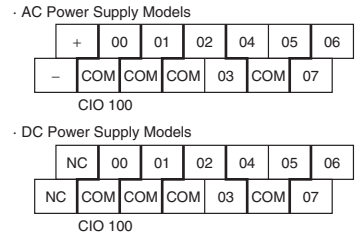

CP1L-M30

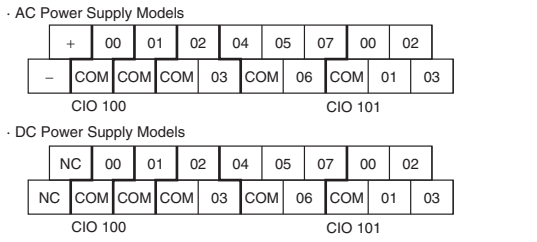

CP1L-L14

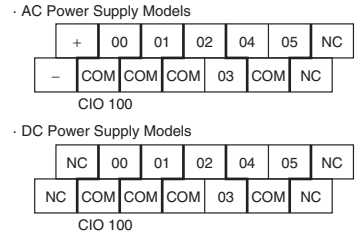

Built-in Output Area

CPU Units

Number of outputs	Output Terminal Block		When the instructions to the right are not executed	When a pulse output instruction (SPED, ACC, PLS2, or ORG) is executed		When the origin search function is set to be used in the PLC Setup, and an origin search is executed by the ORG instruction	When the PWM instruction is executed	
	Word	Bit	Normal output	Fixed duty ratio pulse output			Variable duty ratio pulse output	
				CW/CCW	Pulse plus direction	When the origin search function is used		PWM output
14	CIO 100	00	Normal output 0	Pulse output 0 (CW)	Pulse output 0 (pulse)	---	---	
		01	Normal output 1	Pulse output 0 (CCW)	Pulse output 0 (direction)	---	PWM output 0	
		02	Normal output 2	Pulse output 1 (CW)	Pulse output 1 (pulse)	---	---	
		03	Normal output 3	Pulse output 1 (CCW)	Pulse output 1 (direction)	---	PWM output 1	
		04	Normal output 4	---	---	---	Origin search 0 (Error counter reset output)	---
		05	Normal output 5	---	---	---	Origin search 1 (Error counter reset output)	---
		06	Normal output 6	---	---	---	---	---
20	CIO 100	07	Normal output 7	---	---	---	---	
		08	Normal output 8	---	---	---	---	
30	CIO 101	01	Normal output 9	---	---	---	---	
		02	Normal output 10	---	---	---	---	
		03	Normal output 11	---	---	---	---	
		04	Normal output 12	---	---	---	---	
		05	Normal output 13	---	---	---	---	
		06	Normal output 14	---	---	---	---	
		07	Normal output 15	---	---	---	---	
40	CIO 101	09	Normal output 16	---	---	---	---	
		10	Normal output 17	---	---	---	---	
		11	Normal output 18	---	---	---	---	
		12	Normal output 19	---	---	---	---	
		13	Normal output 20	---	---	---	---	
		14	Normal output 21	---	---	---	---	
		15	Normal output 22	---	---	---	---	

Input Specifications

ITEM	Specifications		
	High-speed counter inputs (phases A and B)	Interrupt inputs and quick-response inputs	Normal inputs
CP1L	CIO 0.00 to CIO 0.03	CIO 0.04 to CIO 0.09	CIO 0.10, CIO 0.11 and CIO 1.00 to CIO 1.11
Input voltage	24 VDC +10%/-15%		
Applicable sensors	2-wire sensors		
Input impedance	3.0 kΩ		4.7 kΩ
Input current	7.5 mA typical		5 mA typical
ON voltage	17.0 VDC min.		14.4 VDC min.
OFF voltage/current	1 mA max. at 5.0 VDC		
ON delay	2.5 μs max.	50 μs max.	1 ms max.
OFF delay	2.5 μs max.	50 μs max.	1 ms max.
Circuit configuration			

High-speed Counter Function Input Specifications

Input bits: CIO 0.00 to CIO 0.03

Item	Specifications
ON/OFF delay	<ul style="list-style-type: none"> Pulse plus direction input mode Increment mode Up/down input mode <ul style="list-style-type: none"> Differential phase input mode

Interrupt Input Counter Mode

Input bits: CIO 0.04 to CIO 0.09

Item	Specifications
ON/OFF delay	

Output Specifications

CPU Units with Relay Outputs

Item	Specifications	
Max. switching capacity	2 A, 250 VAC ($\cos\phi = 1$), 2 A, 24 VDC 4 A/common	
Min. switching capacity	5 VDC, 10 mA	
Service life of relay	Elec-trical	Resistive load: 100,000 operations (24 VDC)
		Inductive load: 48,000 operations (250 VAC, $\cos\phi = 0.4$)
	Mechanical	20,000,000 operations
ON delay	15 ms max.	
OFF delay	15 ms max.	
Circuit configuration		

Note: Under the worst conditions, the service life of output contacts is as shown on the left.

The service life of relays is as shown in the following diagram as a guideline.

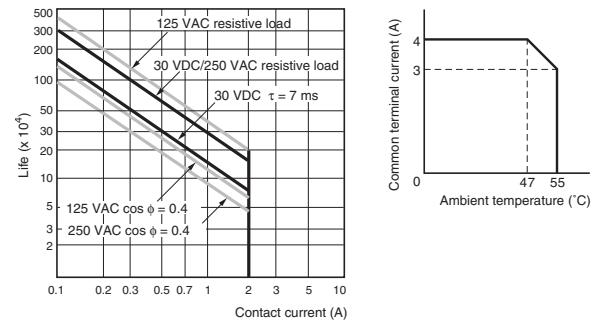

CPU Units with Transistor Outputs (Sinking/Sourcing)

Item	Specifications
CP1L CPU Units	CIO 100.00 to CIO 100.03 --- CIO 100.04 to CIO 101.07
Max. switching capacity	4.5 to 30 VDC: 300 mA/point, 0.9 A/common, 3.6 A/Unit (See notes 3 and 4.)
Min. switching capacity	4.5 to 30 VDC, 1 mA
Leakage current	0.1 mA max.
Residual voltage	0.6 V max. 1.5 V max.
ON delay	0.1 ms max.
OFF delay	0.1 ms max. 1 ms max.
Fuse	1/common (See note 2.)
Circuit configuration	

- Note 1. Do not apply a voltage or connect a load to an output terminal exceeding the maximum switching capacity.
 2. Fuses cannot be replaced by the user.
 3. Do not use more than 0.9 A total for CIO 100.00 to CIO 100.03.
 4. A maximum of 0.9 A per common can be switched at an ambient temperature of 50°C.

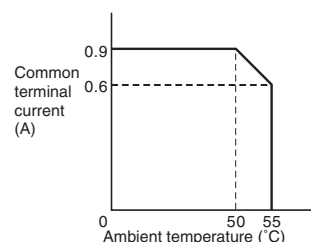

Pulse outputs

Output bits CIO 100.00 to CIO 100.03

Item	Specifications
Max. switching capacity	30 mA at 4.75 to 26.4 VDC
Min. switching capacity	7 mA at 4.75 to 26.4 VDC
Max. output frequency	100 kHz
Output waveform	

- Note 1.** The above values assume a resistive load and do not consider the impedance of the cable connecting the load.
- 2.** The pulse widths during actual use may be smaller than the ones shown above due to pulse distortion caused by connecting cable impedance.



Pulse outputs

Output bits CIO 100.01, CIO 100.03

Item	Specifications
Max. switching capacity	30 mA at 4.75 to 26.4 VDC
Max. output frequency	CP1L: 32.8 kHz
PWM output precision	ON duty +5%, -0% at output frequency of 1 kHz
Output waveform	

- Note 1.** The above values assume a resistive load and do not consider the impedance of the cable connecting the load.
- 2.** The pulse widths during actual use may be smaller than the ones shown above due to pulse distortion caused by connecting cable impedance.

Serial Communications Specifications

Item	Function	Interface
Peripheral USB port	For connecting Peripheral Device.	Conforms to USB 1.1, B-type connector
Serial port 1	Host Link, No-protocol, NT Link (1: N), Serial PLC Link (See note.), Serial Gateway (CompoWay/F master, Modbus-RTU master), Modbus-RTU easy master function	The following can be used for either port. CP1W-CIF01 RS-232C Option Board  CP1W-CIF11 RS-422A/485 Option Board  Can be used with either port.
Serial port 2 (CP1L-M30/M40 only)		

Note: Serial PLC Link can be used with either serial port 1 or serial port 2.

Connecting Expansion Units and Expansion I/O Units

CP-series and CPM1A-series Expansion Units and Expansion I/O Units can be connected to the CP1L. Up to three Expansion Units or Expansion I/O Units can be connected to a CPU Unit with 30 or 40 I/O points and one Expansion Unit or Expansion I/O Unit can be connected to a CPU Unit with 20 or 14 I/O points.

The functionality and performance of CP-series Expansion units and Expansion I/O Units is the same as the functionality and performance of CPM1A-series Expansion Units and Expansion I/O Units. CP-series Units are black, and CPM1A-series units are ivory.

Unit name	Output Method	Inputs	Outputs	Model		
				CP1W	CPM1A	
Expansion I/O Units	8-point Input Unit		8	-	CP1W-8ED	CPM1A-8ED
	8-point Output Unit	Relay	-	8	CP1W-8ER	CPM1A-8ER
		Transistor (sinking)			CP1W-8ET	CPM1A-8ET
		Transistor (sourcing)			CP1W-8ET1	CPM1A-8ET1
	16-point Output Unit	Relay	-	16	CP1W-16ER	-
	20-point I/O Unit	Relay	12	8	CP1W-20EDR1	CPM1A-20EDR1
		Transistor (sinking)			CP1W-20EDT	CPM1A-20EDT
		Transistor (sourcing)			CP1W-20EDT1	CPM1A-20EDT1
	40-point I/O Unit	Relay	24	16	CP1W-40EDR	CPM1A-40EDR
		Transistor (sinking)			CP1W-40EDT	CPM1A-40EDT
Transistor (sourcing)				CP1W-40EDT1	CPM1A-40EDT1	
Expansion Units	Analog I/O Unit	Analog (resolution 1/256)	2	1	-	CPM1A-MAD01
		Analog (resolution 1/6000)			CP1W-MAD11	CPM1A-MAD11
	Analog Input Unit	Analog (resolution 1/6000)	4	-	CP1W-AD041	CPM1A-AD041
	Analog Output Unit	Analog (resolution 1/6000)	-	4	CP1W-DA041	CPM1A-DA041
			-	2	CP1W-DA021	-
	Temperature Sensor Unit	Thermocouple input	2	-	CP1W-TS001	CPM1A-TS001
			4	-	CP1W-TS002	CPM1A-TS002
		Platinum resistance input	2	-	CP1W-TS101	CPM1A-TS101
			4	-	CP1W-TS102	CPM1A-TS102
	Platinum resistance input and voltage/current output	2	1	-	CPM1A-TS101-DA	
	DeviceNet I/O Link Unit	-	I/O link of 32 input bits and 32 output bits	-	-	CPM1A-DRT21
Profibus-DP I/O Link Unit	-	I/O link of 16 input bits and 16 output bits	-	-	CPM1A-PRT21	
CompoBus I/O Link Unit	-	I/O link of 8 input bits and 8 output bits	CP1W-SRT21	CPM1A-SRT21		

CP1W-40EDR/40EDT/40EDT1/20EDR1/20EDT/20EDT1/16ER/8ED/8ER/8ET/8ET1 Expansion I/O Units

Expansion I/O Units can be connected to the CPU Unit to configure the required number of I/O points.

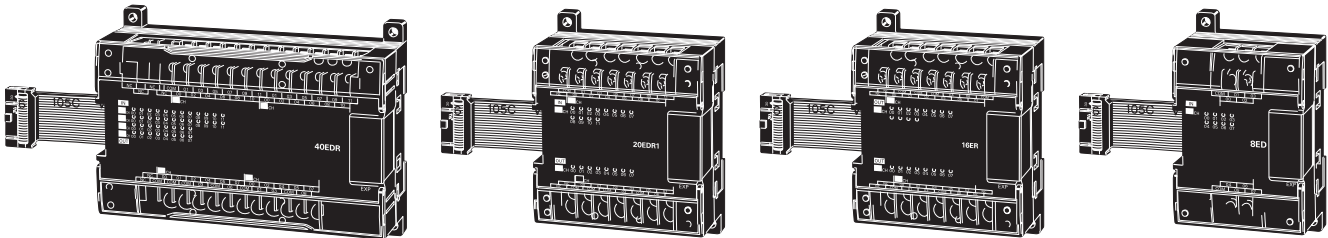

Input Specifications of Expansion I/O Units

DC Inputs
(CP1W-40EDR/40EDT/40EDT1/20EDR1/20EDT/20EDT1/8ED)

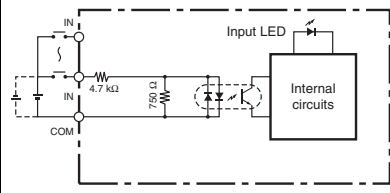
Item	Specifications
Input voltage	24 VDC +10%/-15%
Input impedance	4.7 kΩ
Input current	5 mA typical
ON voltage	14.4 VDC min.
OFF voltage	5.0 VDC max.
ON delay	0 to 32 ms max. (Default: 8 ms) (See note 1.)
OFF delay	0 to 32 ms max. (Default: 8 ms) (See note 1.)
Circuit configuration	

Note 1. Do not apply a voltage exceeding the rated voltage to an input terminal.
 2. Can be set in the PLC Setup to 0, 0.5, 1, 2, 4, 8, 16 or 32 ms.
 The CP1W-40EDR/EDT/EDT1 are fixed at 16 ms.

Relay Outputs
(CP1W-40EDR/20EDR1/16ER/8ER)

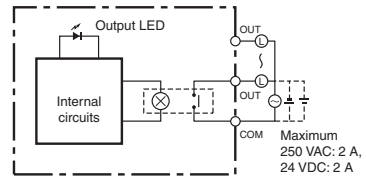
Item	Specifications	
Max. switching capacity	2 A, 250 VAC (cosφ = 1), 24 VDC 4 A/common	
Min. switching capacity	5 VDC, 10 mA	
Service life of relay	Electrical	Resistive load: 150,000 operations (24 VDC)
		Inductive load: 100,000 operations (24 VAC cos φ = 0.4)
	Mechanical	20,000,000 operations
ON delay	15 ms max.	
OFF delay	15 ms max.	
Circuit configuration		

Note: Under the worst conditions, the service life of output contacts is as shown on the left. The service life of relays is as shown in the following diagram as a guideline.

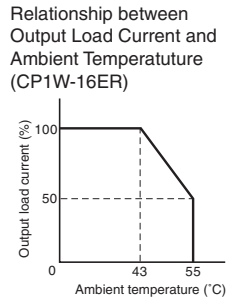
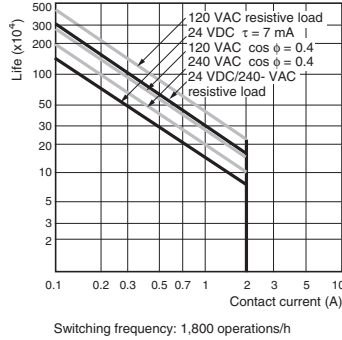

Transistor Outputs (Sinking/Sourcing)

Item	Specifications		
	CP1W-40EDT CP1W-40EDT1	CP1W-20EDT CP1W-20EDT1	CP1W-8ET CP1W-8ET1
Max. switching capacity (See note 3.)	4.5 to 30 VDC: 0.3 A/point 0.9 A/common 3.6 A/common	24 VAC +10%/-5%: 0.3 A/point 0.9 A/common 1.8 A/common	OUT00/OUT01: 0.2 A/point at 4.5 to 30 VDC OUT02 to OUT07: 0.3 A/point at 4.5 to 30 VDC 0.9 A/common 1.8 A/common
Leakage current	0.1 mA max.	0.1 mA max.	0.1 mA max.
Residual voltage	1.5 V max.	1.5 V max.	1.5 V max.
ON delay	0.1 ms max.	0.1 ms max.	0.1 ms max.
OFF delay	1 ms max. at 24 VDC +10%/-5%, 5 to 300 mA	1 ms max. at 24 VDC +10%/-5%, 5 to 300 mA	1 ms max. at 24 VDC +10%/-5%, 5 to 300 mA
Fuse (See note 2.)	None	1/common	
Circuit configuration			

Note 1. Do not apply a voltage or connect a load to an output terminal exceeding the maximum switching capacity.
 2. The fuses cannot be replaced by the user.

3. A maximum of 0.9 A per common can be switched at an ambient temperature of 50°C.

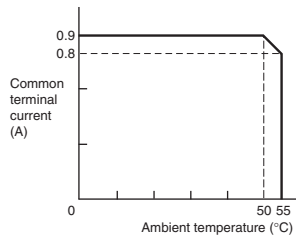

CP1W-AD041/DA041/DA021/MAD11 Analog Units

Analog values that are input are converted to binary data and stored in the input area, or binary data is output as analog values.

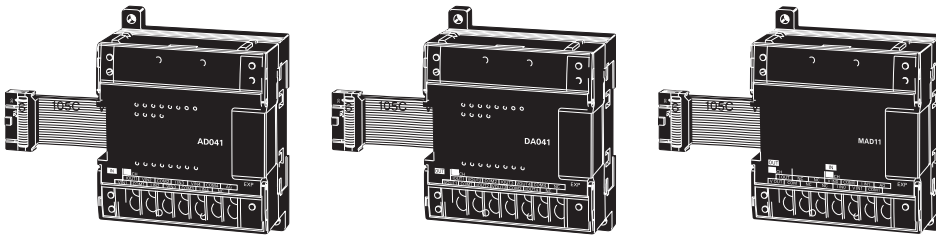

Analog Input Unit: CP1W-AD041

Model		CP1W-AD041	
Item		Input voltage	Input current
Number of inputs		4	
Input signal range		0 to 5 V, 1 to 5 V, 0 to 10 V, -10 to 10 V	0 to 20 mA, 4 to 20 mA
Max. rated input		±15 V	±30 mA
External input impedance		1 MΩ min.	Approx. 250 Ω
Resolution		6000	
Overall accuracy	25°C	±0.3% of full scale	±0.4% of full scale
	0 to 55°C	±0.6% of full scale	±0.8% of full scale
Conversion time		2.0 ms/point	
A/D conversion data		Binary data with resolution of 6,000 Full scale for -10 to 10 V: F448 to 0BB8 hex Full scale for other ranges: 0000 to 1770 hex	
Averaging		Supported.	
Open-circuit detection		Supported.	
Insulation resistance		20 MΩ min. (at 250 VDC, between isolated circuits)	
Dielectric strength		500 VAC for 1 min (between isolated circuits)	
Isolation method		Photocoupler isolation (between analog inputs and secondary internal circuits). No isolation between input signals.	

Analog Output Unit: CP1W-DA041/DA021

Model		CP1W-DA041/DA021	
Item		Output voltage	Output current
Number of outputs		DA041: 4, DA021: 2	
Output signal range		0 to 5 V, 0 to 10 V, or -10 to 10 V	0 to 20 mA or 4 to 20 mA
Allowable external output load resistance		2 kΩ min.	350 Ω max.
External output impedance		0.5 Ω max.	---
Resolution		6000	
Overall accuracy	25°C	±0.4% of full scale	
	0 to 55°C	±0.8% of full scale	
Conversion time		2.0 ms/point	
D/A conversion data		Binary data with resolution of 6,000 Full scale for -10 to 10 V: F448 to 0BB8 hex Full scale for other ranges: 0000 to 1770 hex	
Insulation resistance		20 MΩ min. (at 250 VDC between isolated circuits)	
Dielectric strength		500 VAC for 1 min between isolated circuits	
Isolation method		Photocoupler isolation between analog inputs and secondary internal circuits. No isolation between analog input signals.	

Analog I/O Unit: CP1W-MAD11

Model		CP1W-MAD11		
Item		Voltage I/O	Current I/O	
Analog Input Section	Number of inputs	2 inputs		
	Input signal range	0 to 5 V, 1 to 5V, 0 to 10 V, or -10 to 10V		
	Max. rated input	±15 V		
	External input impedance	1 MΩ min.		
	Resolution	1/6000 (full scale)		
	Overall accuracy	25°C	±0.3% of full scale	±0.4% of full scale
		0 to 55°C	±0.6% of full scale	±0.8% of full scale
A/D conversion data	Binary data (hexadecimal, 4 digits) -10 to 10 V: F448 to 0BB8 hex Full scale for other ranges: 0000 to 1770 hex			
Analog Output Section (See note 1.)	Averaging	Supported (Set for each input using a DIP switch.)		
	Disconnection detection	Supported		
	Number of outputs	1 output		
	Output signal range	1 to 5 V, 0 to 10 V, -10 to 10 V	0 to 20 mA, 4 to 20 mA	
	External output max. current	---		
	Allowable external output load resistance	1 kΩ min.	600 Ω max.	
	External input impedance	0.5 Ω max.	---	
	Resolution	1/6000 (full scale)		
	Overall accuracy	25°C	±0.4% of full scale	±0.8% of full scale
		0 to 55°C	±0.8% of full scale	
	Data setting	---		
D/A conversion data	Binary data (hexadecimal, 4 digits) -10 to 10 V: F448 to 0BB8 hex Full scale for other ranges: 0000 to 1770 hex			
Conversion time (See note 2.)	2 ms/point (6 ms for all points)			
Isolation method	Photocoupler isolation between analog I/O and internal circuits (There is no isolation between the analog I/O signals.)			

Note 1. The voltage output and current output can be used at the same time for analog outputs, but the total output current must not exceed 21 mA.

Note 2. The conversion time is the total time for 2 analog inputs and 1 analog output.

Temperature Sensor Units: CP1W-TS001/TS002/TS101/TS102

By mounting a Temperature Sensor Unit to the PLC, inputs can be obtained from thermocouples or platinum resistance thermometers, and temperature measurements can be converted to binary data (4-digit hexadecimal) and stored in the input area of the CPU Unit.

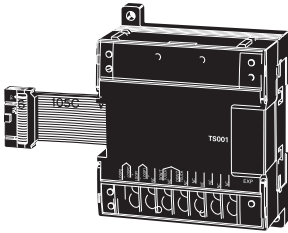

Specifications

Item	Model	CP1W-TS001/002	CP1W-TS101/102
Number of inputs		2 (TS001), 4 (TS002)	2 (TS101), 4 (TS102)
Input types		K, J switchable (Note: Same for all inputs.)	Pt100, JPt100 switchable (Note: Same for all inputs.)
Indication accuracy		(The larger of the indicated value: $\pm 0.5\%$ and $\pm 2^\circ\text{C}$ (See note.)) ± 1 digit max.	(The larger of the indicated value: $\pm 0.5\%$ and $\pm 1^\circ\text{C}$) ± 1 digit max.
Conversion time		250 ms/2 points (TS001, TS101); 250 ms/4 points (TS002, TS102)	
Converted temperature data		Binary (4-digit hexadecimal)	
Isolation method		Photocoupler isolation between the temperature input signals.	

Note: The indication accuracy when using a K-type thermocouple for temperature less than -100°C is $\pm 4^\circ\text{C} \pm 1$ digit max.

Input Temperature Ranges for CP1W-TS001/002
(The rotary switch can be used to make the following range and input type settings.)

Input type	Range ($^\circ\text{C}$)	Range ($^\circ\text{F}$)
K	-200 to 1300	-300 to 2300
	0.0 to 500.0	0.0 to 900.0
J	-100 to 850	-100 to 1500
	0.0 to 400.0	0.0 to 750.0

Input Temperature Ranges for CP1W-TS101/102
(The rotary switch can be used to make the following range and input type settings.)

Input type	Range ($^\circ\text{C}$)	Range ($^\circ\text{F}$)
Pt100	-200.0 to 650.0	-300 to 1200.0
JPt100	-200.0 to 650.0	-300 to 1200.0

CP1W-SRT21 CompoBus/S I/O Link Unit

The CompoBus/S I/O Link Unit functions as a slave for a CompoBus/S Master Unit (or an SRM1 CompoBus/S Master Control Unit) to form an I/O Link with 8 inputs and 8 outputs between the CompoBus/S I/O Link Unit and the Master Unit.

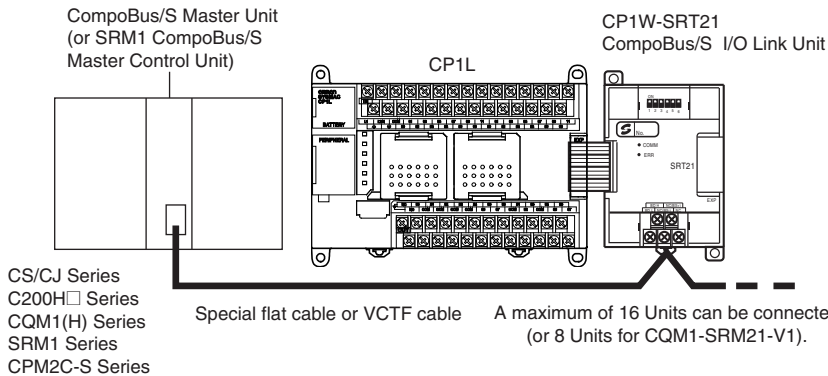
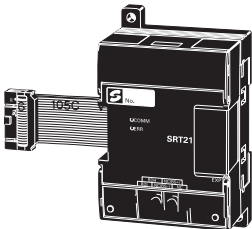

Specifications

Item	Model	CP1W-SRT21
Master/Slave		CompoBus/S Slave
Number of I/O bits		8 input bits, 8 output bits
Number of words occupied in CP1L I/O memory		1 input word, 1 output word (Allocated in the same way as for other Expansion Units)
Node number setting		Set using the DIP switch (before the CPU Unit is turned ON.)

Dimensions

(Unit: mm)

CP1L CPU Units with 40 I/O Points

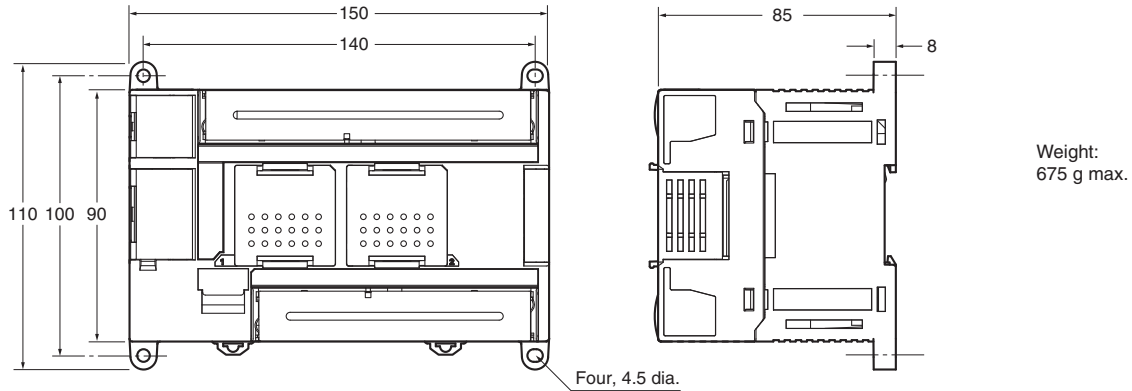

CP1L CPU Units with 30 I/O Points

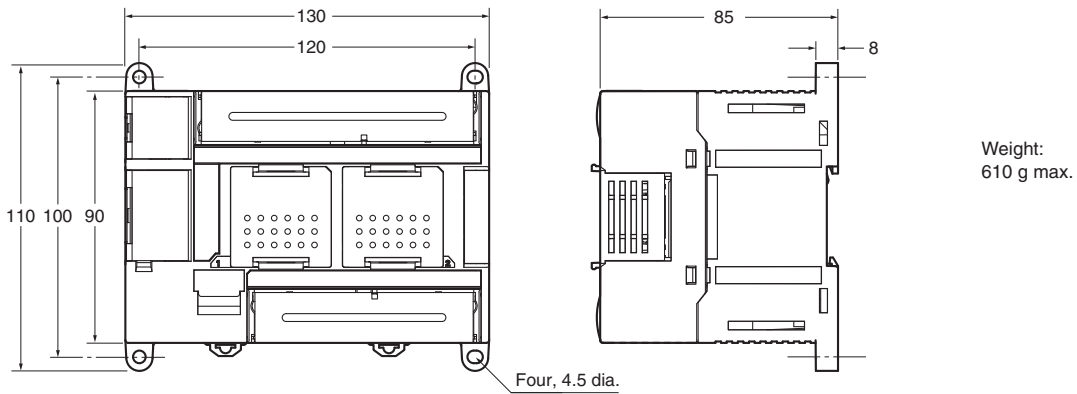

CP1L CPU Units with 14 or 20 I/O Points

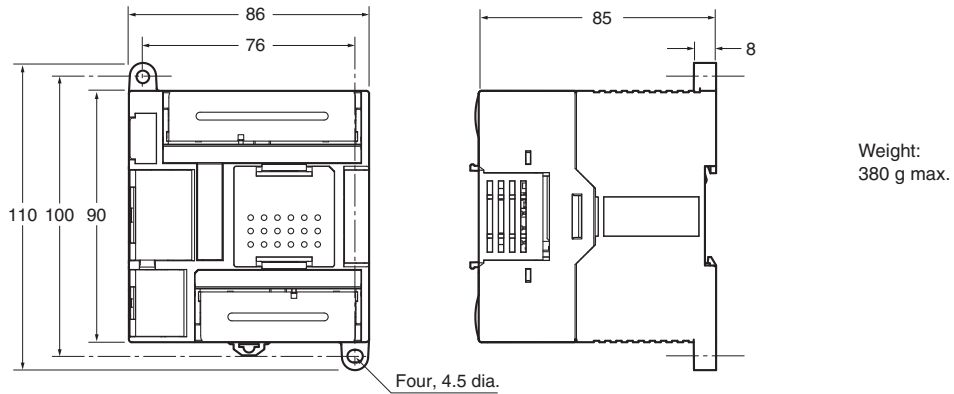

Expansion Units and Expansion I/O Units

CP1W-20ED□

CP1W-16ER

CP1W-AD041/CP1W-DA041/CP1W-DA021

CP1W-MAD11/CP1W-TS□□□

CP1W-8E□□

CP1W-SRT21

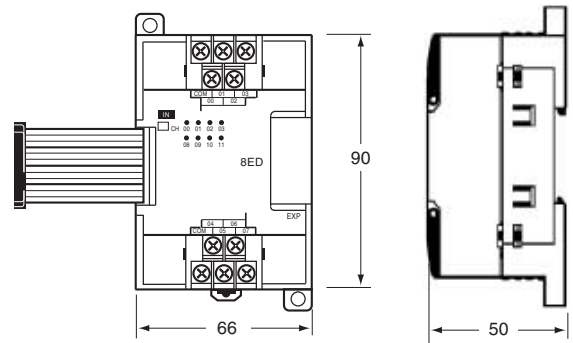
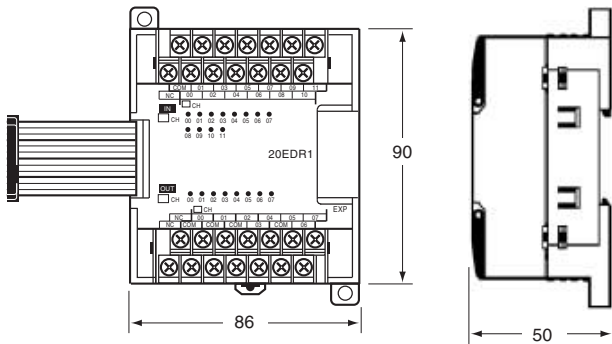

CP1W-40ED□

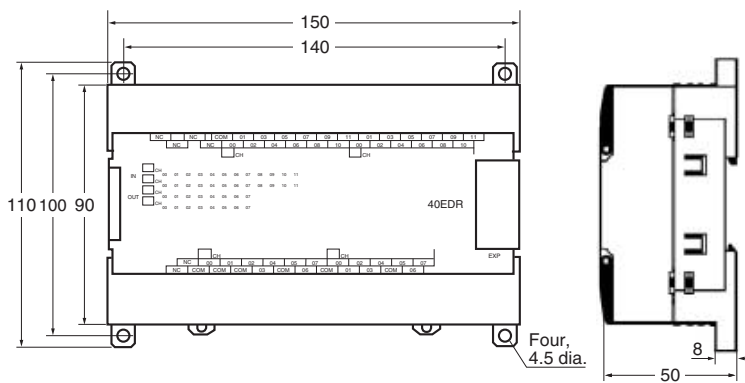

Unit name	Model number	Weight
Expansion I/O Units	CP1W-40EDR	380 g
	CP1W-40EDT/-40EDT1	320 g
	CP1W-20EDR1/-20EDT/-20EDT1	300 g
	CP1W-16ER	280 g
	CP1W-8ED	200 g
	CP1W-8ER/-8ET/-8ET1	250 g
Analog Units	CP1W-AD041/-DA041/-DA021	200 g
	CP1W-MAD11	150 g
Temperature Sensor Units	CP1W-TS001/-TS002/-TS101/-TS102	250 g
CompoBus/S I/O Link Unit	CP1W-SRT21	200 g



Ordering Information

CPU Units

International Standards

The standards indicated in the "Standards" column are those current for UL, CSA, cULus, NK, and Lloyd standards and EC Directives as of the end of April 2007. The standards are abbreviated as follows: U: UL, U1: UL (Class I Division 2 Products for Hazardous Locations), C: CSA, UC: cULus, UC1: cULus (Class I Division 2 Products for Hazardous Locations), CU: cUL, N: NK, L: Lloyd, and CE: EC Directives
 Ask your OMRON representative for the conditions under which the standards were met.

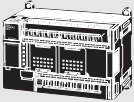
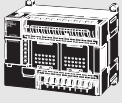
CP1L CPU Units

CPU Unit	Specifications				Model	Standards	
	Power supply	Output method	Inputs	Outputs			
CP1L-M CPU Units with 40 Points 	AC power supply	Relay output	24	16	CP1L-M40DR-A	UC1, N, L, CE	
	DC power supply				Transistor output (sinking)		CP1L-M40DR-D
					Transistor output (sourcing)		CP1L-M40DT-D
							CP1L-M40DT1-D
CP1L-M CPU Units with 30 Points 	AC power supply	Relay output	18	12	CP1L-M30DR-A	UC1, N, L, CE	
	DC power supply				Transistor output (sinking)		CP1L-M30DR-D
					Transistor output (sourcing)		CP1L-M30DT-D
							CP1L-M30DT1-D
CP1L-L CPU Units with 20 Points 	AC power supply	Relay output	12	8	CP1L-L20DR-A	UC1, N, L, CE	
	DC power supply				Transistor output (sinking)		CP1L-L20DR-D
					Transistor output (sourcing)		CP1L-L20DT-D
							CP1L-L20DT1-D
CP1L-L CPU Units with 14 Points 	AC power supply	Relay output	8	6	CP1L-L14DR-A	UC1, N, L, CE	
	DC power supply				Transistor output (sinking)		CP1L-L14DR-D
					Transistor output (sourcing)		CP1L-L14DT-D
							CP1L-L14DT1-D

Options for CPU Units







Name	Specifications	Model	Standards
RS-232C Option Board	For CPU Unit option port.	CP1W-CIF01	UC1, N, L, CE
RS-422A/485 Option Board	For CPU Unit option port.	CP1W-CIF11	
Memory Cassette	Can be used for backing up programs or auto-booting.	CP1W-ME05M	

Programming Devices

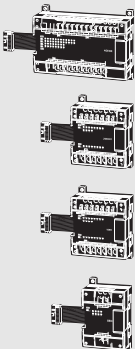
Name	Specifications	Model	Standards	
CX-One FA Integrated Tool Package Ver. 2.0	CX-One is a package that integrates the Support Software for OMRON PLCs and components. CX-One runs on the following OS. OS: Windows 98SE, Me, NT 4.0 (Service Pack 6a), 2000 (Service Pack 3 or higher), or XP *CX-Thermo runs only on Windows 2000 (Service Pack 3 or higher) or XP. CX-One Ver. 2.0 includes CX-Programmer Ver. 7.□. For details, refer to the CX-One catalog (Cat. No. R134). *The software is provided on CDs for the CXONE-AL□□□□-□EV2 and on DVD for the CXONE-AL□□□□D-□EV2. *Site licenses are available for users who must run the CX-One on many computers. Ask your OMRON representative for details.	1 license	CXONE-AL01C-EV2 CXONE-AL01D-EV2	---
		3 licenses	CXONE-AL03C-EV2 CXONE-AL03D-EV2	
		10 licenses	CXONE-AL10C-EV2 CXONE-AL10D-EV2	
		50 licenses	CXONE-AL50C-EV2 CXONE-AL50D-EV2	
USB Programming cable	A-type male to B-type male (Length: 1.8 m)	CP1W-CN221	---	
Programming Device Connecting Cable for CP1W-CIF01 RS-232C Option Board	Connects DOS computers, D-Sub 9-pin (Length: 2.0 m)	For anti-static connectors	XW2Z-200S-CV	---
	Connects DOS computers, D-Sub 9-pin (Length: 5.0 m)		XW2Z-500S-CV	
	Connects DOS computers, D-Sub 9-pin (Length: 2.0 m)		XW2Z-200S-V	
	Connects DOS computers, D-Sub 9-pin (Length: 5.0 m)		XW2Z-500S-V	
USB-Serial Conversion Cable (See note)	USB-RS-232C Conversion Cable (Length: 0.5 m) and PC driver (on a CD-ROM disc) are included. Complies with USB Specification 1.1 On personal computer side: USB (A plug connector, male) On PLC side: RS-232C (D-sub 9-pin, male) Driver: Supported by Windows 98, Me, 2000, and XP	CS1W-CIF31		

- Note:** 1. Cannot be used with a peripheral USB port.
 2. CP1L PLCs are supported by CX-Programmer version 7.1 or higher.

Expansion Units

Name	Output method	Inputs	Outputs	Model	Standards	
Expansion I/O Units 	Relay	24	16	CP1W-40EDR	N, L, CE	
	Transistor (sinking)			CP1W-40EDT		
	Transistor output (sourcing)			CP1W-40EDT1		
	Relay	12	8	CP1W-20EDR1	U, C, L, CE	
	Transistor (sinking)			CP1W-20EDT	U, C, N, L, CE	
	Transistor output (sourcing)			CP1W-20EDT1		
	Relay	---	8	16	CP1W-16ER	CE
	---	---		---	CP1W-8ED	U, C, N, L, CE
	Relay	---	---	8	CP1W-8ER	
	Transistor (sinking)	---		8	CP1W-8ET	
	Transistor output (sourcing)	---		---	CP1W-8ET1	
	Analog Input Unit 	Analog (resolution: 1/6000)	4	---	CP1W-AD041	UC1, CE
Analog Output Unit 	Analog (resolution: 1/6000)	---	4	CP1W-DA041	UC1, CE	
		---	2	CP1W-DA021	UC1, CE	
Analog I/O Unit 	Analog (resolution: 1/6000)	2	1	CP1W-MAD11	U, C, N, CE	
CompoBus/S I/O Link Unit 	---	8 (I/O link input bits)	8 (I/O link input bits)	CP1W-SRT21	U, C, N, L, CE	
Temperature Sensor Unit 	2 thermocouple inputs			CP1W-TS001	U, C, N, L, CE	
	4 thermocouple inputs			CP1W-TS002		
	2 platinum resistance thermometer inputs			CP1W-TS101		
	4 platinum resistance thermometer inputs			CP1W-TS102		

Optional Products, Maintenance Products and DIN Track Accessories

Name	Specifications	Model	Standards
Battery Set	For CP1L CPU Units (Use batteries within two years of manufacture.)	CJ1W-BAT01	CE
DIN Track	Length: 0.5 m; Height: 7.3 mm	PFP-50N	---
	Length: 1 m; Height: 7.3 mm	PFP-100N	
	Length: 1 m; Height: 16 mm	PFP-100N2	
End Plate	There are 2 stoppers provided with CPU Units and I/O Interface Units as standard accessories to secure the Units on the DIN Track.	PFP-M	

Read and Understand this Catalog

Please read and understand this catalog before purchasing the product. Please consult your OMRON representative if you have any questions or comments.

Warranty and Limitations of Liability**WARRANTY**

OMRON's exclusive warranty is that the products are free from defects in materials and workmanship for a period of one year (or other period if specified) from date of sale by OMRON.

OMRON MAKES NO WARRANTY OR REPRESENTATION, EXPRESS OR IMPLIED, REGARDING NON-INFRINGEMENT, MERCHANTABILITY, OR FITNESS FOR PARTICULAR PURPOSE OF THE PRODUCTS. ANY BUYER OR USER ACKNOWLEDGES THAT THE BUYER OR USER ALONE HAS DETERMINED THAT THE PRODUCTS WILL SUITABLY MEET THE REQUIREMENTS OF THEIR INTENDED USE. OMRON DISCLAIMS ALL OTHER WARRANTIES, EXPRESS OR IMPLIED.

LIMITATIONS OF LIABILITY

OMRON SHALL NOT BE RESPONSIBLE FOR SPECIAL, INDIRECT, OR CONSEQUENTIAL DAMAGES, LOSS OF PROFITS OR COMMERCIAL LOSS IN ANY WAY CONNECTED WITH THE PRODUCTS, WHETHER SUCH CLAIM IS BASED ON CONTRACT, WARRANTY, NEGLIGENCE, OR STRICT LIABILITY.

In no event shall the responsibility of OMRON for any act exceed the individual price of the product on which liability is asserted.

IN NO EVENT SHALL OMRON BE RESPONSIBLE FOR WARRANTY, REPAIR, OR OTHER CLAIMS REGARDING THE PRODUCTS UNLESS OMRON'S ANALYSIS CONFIRMS THAT THE PRODUCTS WERE PROPERLY HANDLED, STORED, INSTALLED, AND MAINTAINED AND NOT SUBJECT TO CONTAMINATION, ABUSE, MISUSE, OR INAPPROPRIATE MODIFICATION OR REPAIR.

Application Considerations**SUITABILITY FOR USE**

OMRON shall not be responsible for conformity with any standards, codes, or regulations that apply to the combination of the product in the customer's application or use of the product.

Take all necessary steps to determine the suitability of the product for the systems, machines, and equipment with which it will be used.

Know and observe all prohibitions of use applicable to this product.

NEVER USE THE PRODUCT FOR AN APPLICATION INVOLVING SERIOUS RISK TO LIFE OR PROPERTY WITHOUT ENSURING THAT THE SYSTEM AS A WHOLE HAS BEEN DESIGNED TO ADDRESS THE RISKS, AND THAT THE OMRON PRODUCT IS PROPERLY RATED AND INSTALLED FOR THE INTENDED USE WITHIN THE OVERALL EQUIPMENT OR SYSTEM.

PROGRAMMABLE PRODUCTS

OMRON shall not be responsible for the user's programming of a programmable product, or any consequence thereof.

Disclaimers**CHANGE IN SPECIFICATIONS**

Product specifications and accessories may be changed at any time based on improvements and other reasons. Consult with your OMRON representative at any time to confirm actual specifications of purchased product.

DIMENSIONS AND WEIGHTS

Dimensions and weights are nominal and are not to be used for manufacturing purposes, even when tolerances are shown.

PERFORMANCE DATA

Performance data given in this catalog is provided as a guide for the user in determining suitability and does not constitute a warranty. It may represent the result of OMRON's test conditions, and the users must correlate it to actual application requirements. Actual performance is subject to the OMRON Warranty and Limitations of Liability.

OMRON EUROPE B.V.

Wegalaan 67-69,
NL-2132 JD, Hoofddorp,
The Netherlands
Phone: +31 23 568 13 00
Fax: +31 23 568 13 88
www.industrial.omron.eu