

### 72 x72 mm Timer with Easy-to-use Functions

- Nine output modes accommodate a wide variety of applications.
- All parameters set by scroll-through menus accessed from the front panel.
- Field-selectable time ranges from 0.001 second to 9999 hours.
- High visibility LCD display with built-in backlight.
- Batch counting Function records the number of completed cycles.
- Contact and solid-state outputs available simultaneously.
- Precision control possible to 0.001 second.
- Four levels of key protection provided.
- Selectable elapsed time (UP) and remaining time (DOWN) display.
- Conforms to EMC standards.
- Six-language instruction manual provided.



### Ordering Information

|                       |           |   |
|-----------------------|-----------|---|
| <b>Functions</b>      |           | 9 field selectable  |
| <b>Contact type</b>   |           | One SPDT relay and two NPN open collector transfer output |
| <b>Terminal form</b>  |           | 18 terminal screws on rear of case                        |
| <b>Part number</b>    |           | H5BR-B  |
| <b>Supply voltage</b> | <b>AC</b> | 24/100 to 240 V, 50/60 Hz                                 |
|                       | <b>DC</b> | 12 to 24 V  |

**Note:** Specify both the model and control power supply when ordering.

#### Model Legend

H5BR -

└── Type classifier

**B: Standard**

#### Accessories (Order Separately)

|                         |           |
|-------------------------|-----------|
| Soft cover              | Y92A-72F1 |
| Shock prevention cover* | Y92A-72T  |

**Note:** Models with a shock prevention cover can be ordered by adding "-500" to the end of the model number. e.g., H5BR-B-500 (100 to 240 VAC, 50/60 Hz)  
The cover provides finger protection conforming to VDE0106/P100.

Soft cover

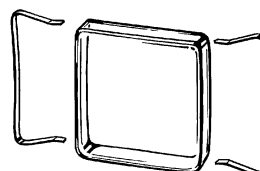

Y92A-72F1

Shock Prevention Cover

(conforming to VDE0106/P100)

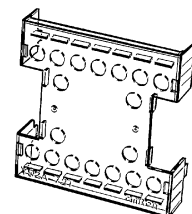

Y92A-72T



## ■ Ratings

|   |   |
|---|---|
| Rated supply voltage                          | 100 to 240 VAC, 50/60 Hz<br>24 VAC/12 to 24 VDC (permissible ripple: 20% max.)  |
| Operating voltage range                       | 85% to 110% of rated voltage  |
| Power consumption                             | Approx. 8 VA at 50 Hz, 240 VAC; approx. 5 W at 24 VDC   |
| Reset and control signals                     | Min. pulse width 1 ms/20ms selectable   |
| Batch count reset and gate                    | Min. pulse width: Approx. 20 ms   |
| Key protect                                   | Response time: 1 s  |
| One-shot time                                 | 0.1 to 99.9 s or hold   |
| Power reset (except A-3, b-1, and F mode)     | Min. power opening time: 0.5 s  |
| Signal, reset, gate, batch count reset inputs | No-voltage input<br>ON impedance: 1 k $\Omega$ max. (Approx. 2 mA when 0 $\Omega$ )<br>ON residual voltage: 2 V max.<br>OFF impedance: 100 k $\Omega$ min.      |
| Key protect input                             | No-voltage input<br>ON impedance: 1 k $\Omega$ max. (Approx. 2 mA when 0 $\Omega$ )<br>ON residual voltage: 1 V max.<br>OFF impedance: 100 k $\Omega$ min.      |
| Control outputs                               | Contacts: 5 A at 250 VAC, resistance load ( $\cos \phi = 1$ )<br>Transistor output: Open collector 100mA at 30 VDC max. residual voltage 2 V max. (Approx. 1 V) |
| External power supply                         | 80 mA, 12 VDC $\pm 10\%$ (5% ripple max.)   |
| Ambient temperature                           | -10°C to 55°C (with no icing)   |
| Storage temperature                           | -25°C to 65°C (with no icing)   |
| Ambient humidity                              | 35% to 85%  |
| Case  | Light gray  |

## ■ Characteristics

|  |   |  |
|--|---|--|
| Repeat accuracy, setting error (including temperature and voltage effects) | Power start: $\pm 0.01\%$ $\pm 0.05$ s max.<br>Control signal start: $\pm 0.005\%$ $\pm 0.03$ s max. *(rate for set value)  |  |
| Insulation resistance  | 100 M $\Omega$ min. (at 500 VDC) (between current-carrying terminal and exposed non-current-carrying metal parts, and between non-continuous contacts)  |  |
| Dielectric strength  | 2,000 VAC, 50/60 Hz for 1 min (between current-carrying terminal and exposed non-current-carrying metal parts) for 100 to 240 VAC type<br>1,000 VAC for 24VAC/12 to 24 VDC type   |  |
| Impulse withstand voltage  | 3 kV (between power terminals) for 100 to 240 VAC type, 1 kV for 24 VAC/12 to 24 VDC type<br>4.5 kV (between current-carrying terminal and exposed non-current-carrying metal parts) for 100 to 240 VAC type, 1.5 kV for 24 VAC/12 to 24 VDC type |  |
| Noise immunity   | $\pm 2$ kV (between power terminals) and $\pm 600$ V (between input terminals), square-wave noise by noise simulator (pulse width: 100 ns/1 $\mu$ s, 1-ns rise)   |  |
| Static immunity  | Malfunction: 8 kV; destruction: 15 kV   |  |
| Vibration  | <b>Destruction</b>  | 10 to 55 Hz with 0.75-mm single amplitude each in three directions |
|  | <b>Malfunction</b>  | 10 to 55 Hz with 0.5-mm single amplitude each in three directions  |
| Shock  | <b>Destruction</b>  | 294 m/s <sup>2</sup> (30G) each in three directions                |
|  | <b>Malfunction</b>  | 98 m/s <sup>2</sup> (10G) each in three directions                 |
| Life expectancy  | <b>Mechanical</b>   | 10 million operations min.   |
|  | <b>Electrical</b>   | 100,000 operations min. (5 A at 250 VAC in load resistance)        |
| Weight   | Approx. 270 g (9.6 oz)  |  |

# Nomenclature

## Display

1. Power indicator
2. Signal input indicator
3. Reset indicator
4. Gate indicator
5. Key protection indicator
6. Control output indicator
7. Batch output indicator
8. Present value  
(character height: 12mm) (Non significant zeroes suppressed)
9. Set value  
(character height: 8 mm)  
(Indicates value in set function mode)
10. Mode indicator
11. Timing indicator
12. Elapsed time indicator  
(Indicates the fraction of a unit which has elapsed. Displayed for timing ranges of 999.9 min. or greater.)

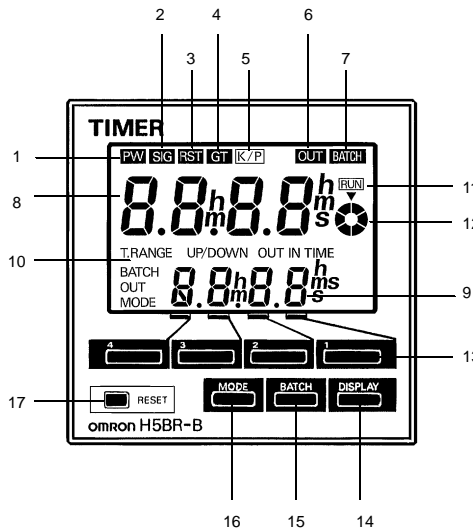

## Operation key

13. Increment keys (1 to 4)  
(Used to change the corresponding digit of the set value. Used to change data in the setting mode.)
14. Display key  
(Switches to the present value display.)
15. Batch key  
(Switches to the batch display.)
16. Mode key  
(Switches from run mode to setting mode. Changes items in the setting mode.)
17. Reset key  
(Resets timing and outputs.)

## ■ Factory Settings

The following table shows the timer settings when it is shipped. Please change the settings as necessary to suit the system before operation. Settings and the display receive power from the internal battery and are therefore unaffected by external power interruptions.

|                            |                        |
|----------------------------|------------------------|
| <b>Model</b>               | H5BR-B (Standard)      |
| <b>Time range</b>          | - - - -s               |
| <b>Present value</b>       | 0.00 s                 |
| <b>Presets</b>             | 0.00 s                 |
| <b>Batch present count</b> | 0                      |
| <b>Batch setting count</b> | 0                      |
| <b>UP/DOWN mode</b>        | UP                     |
| <b>Output mode</b>         | A: Signal on delay (I) |
| <b>Output time</b>         | Hold                   |
| <b>Input signal time</b>   | 20 ms                  |
| <b>Key protect level</b>   | KP-1                   |

**Note:** With the initial settings, there will be no output even if the power supply is connected. External inputs and outputs cannot be used without a power supply.

# Operation

## ■ Block Diagram

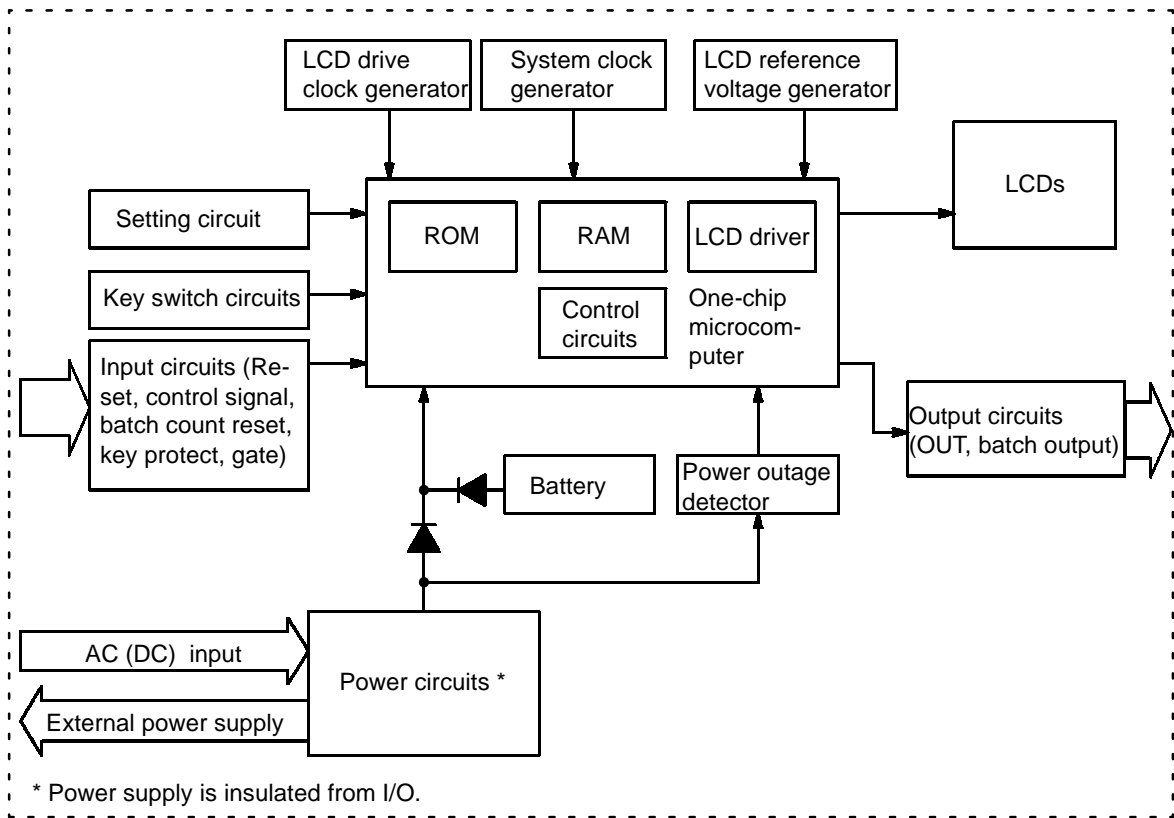

## ■ I/O Functions



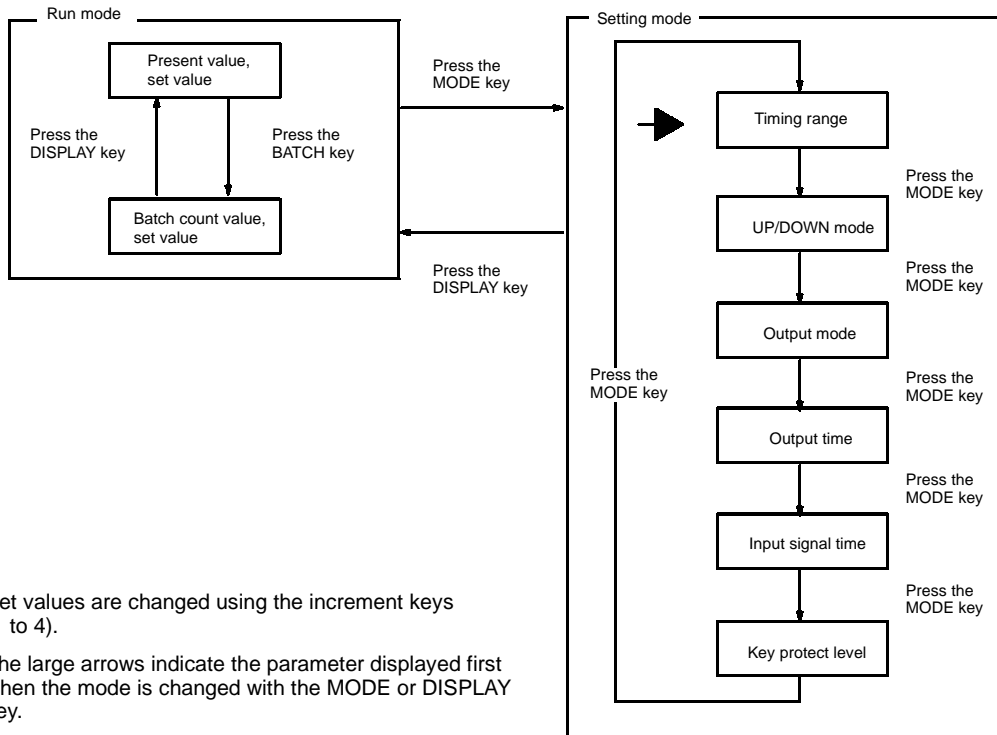

|                |                             |  |
|----------------|-----------------------------|--|
| <b>Inputs</b>  | <b>Start signal</b>         | Stops timing in A-2 and A-3 (power on delay) modes. Starts timing in other modes.  |
|                | <b>Reset</b>                | Resets present value. (to zero in UP modes, to preset in DOWN mode. Count inputs are not accepted while reset input is ON. Reset indicator lit while reset input is ON.  |
|                | <b>Gate</b>                 | Inhibits timer operation.  |
|                | <b>Batch count reset</b>    | Resets batch count to zero and batch output turns OFF on leading edge. Batch count signals are not accepted while batch count reset is ON.   |
|                | <b>Key protect</b>          | Makes keys inoperative according to key protect level. Key protected indicator lit while key protect input is ON. Effective when power supply is turned off. Effective when protect terminals are shorted.                         |
| <b>Outputs</b> | <b>Control output (OUT)</b> | Outputs made according to designated output mode when corresponding preset is reached.   |
|                | <b>Batch output</b>         | Outputs made when batch count equals the preset number of batches. Batch output remains ON until batch count reset goes ON. When the number of batches is set to zero, batch counting is performed but batch outputs are not made. |

### Operational Overview

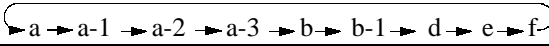

- Note: 1. Set values are changed using the increment keys (1 to 4).
2. The large arrows indicate the parameter displayed first when the mode is changed with the MODE or DISPLAY key.

■ Setting Item Table

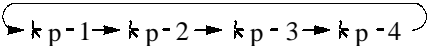
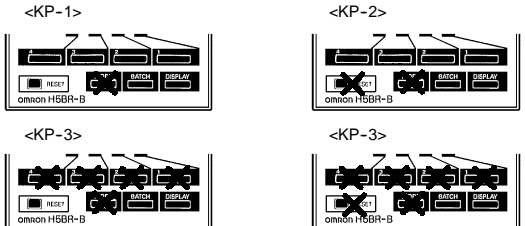
| Mode         | Setting item          | Description  | Setting procedure  |
|--------------|-----------------------|--|--|
| Run mode     | Set value             | Compared to the present value. Determines the timing of the control output according to the output mode.   | Sequence when changing a digit using the increment keys (1 to 4).<br>  |
|              | Batch count set value | Turns ON the batch output when the preset number of cycles have been completed.  | Sequence when changing a digit using the increment keys (1 to 4).<br>  |
| Setting mode | Time range*           | Determines the timing range.   | Change the timing range with the increment keys (1 to 4).  |
|              | UP/DOWN mode          | Selects  | Select UP/DOWN with the increment keys (1 to 4).<br><br>(UP) u ↔ d (DOWN)  |
|              | Output mode           | Determines the form of the control output. (Refer to the present value vs. output diagrams on page 10 to 12.)  | Sequence when changing the mode using the increment keys (1 to 4).<br>   |
|              | Output time           | Determines the duration of the control output. Will be displayed when the output mode is A, A-1, A-2, A-3, b, or b-1. Will not be displayed when the output mode is d, E, or F.  | Use keys 1 to 3 to change the value.<br>Key1 adjusts the first digit (0.1's digit).<br>Key2 adjusts the second digit (1's digit).<br>Key3 adjusts the third digit (10's digit).<br><br>Key4 selects either hold output or one-shot output.<br>hold ↔ 0.0 s |
|              | Input signal time     | Changes the duration of the control and reset input signals.   | Change the duration with the increment keys (1 to 4).<br><br>(1 ms) 1 ↔ 20 (20 ms)   |
|              | Key protect level     | Locks certain keys to prevent accidental operation. The key protection level, kP-1 to kP-4, determines which keys are locked when the key protection input is ON. The locked keys are crossed out in the diagram on the right. | Sequence when changing the key protect level using the increment keys (1 to 4).<br><br>  |

**Note:** 1. Changes made in setting mode become effective when run mode is entered.  
 2. The time range setting appears first when setting mode is entered.

## ■ Examples

### Run Mode

#### Changing the Set Value

To change the set value from 3 hr 5 min to 4 hr 5 min, press the 3 key so that the number 4 appears in the hour's place.

- Pressing keys 1 through 4 increments the corresponding column by 1.
- The columns can be changed in any order, but the output will be turned ON if the set value is less than the present value.
- Nonsignificant zeros are normally not shown on the set value display.

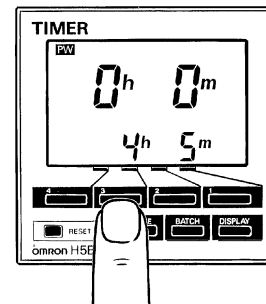

**Note:** Read *Changing Set Values* in the *Precautions* section, pg. 15, before changing the Timer set value during operation.

#### Changing the Batch Count Set Value

1. Press the BATCH key to switch from the present value display to the batch count display.

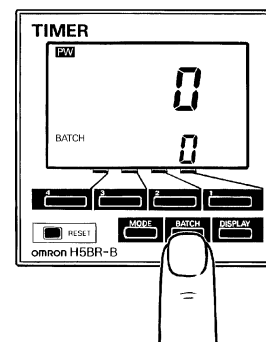

2. Change the set value when the Timer is set to the batch count display.
  - Nonsignificant zeros are normally suppressed on the batch count set value display.
  - Press the DISPLAY key to switch back from the batch count display to the present value display.

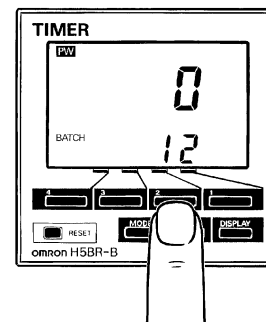



## Setting Mode

### Changing Settings in the Setting Mode

- Press the MODE key to switch from run mode to setting mode.
  - The Timer will continue operation if switched from run mode to setting mode during operation.
  - The MODE key will be locked if the key protection function is enabled.
  - Settings changed in the setting mode are not effective until run mode is entered. As the operating conditions will change in this case, always reset operation with the RESET key or a reset input.

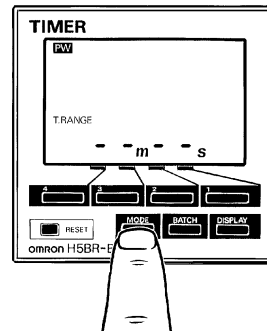

- Press the MODE key to scroll successively through the items that can be set.

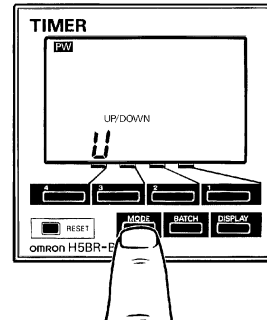

- Changing the selected item
  - Press the MODE key until the desired item appears.

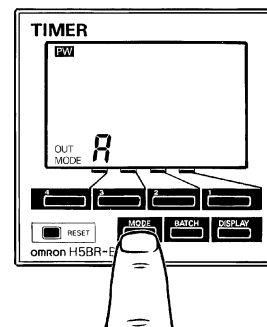

- Change the item setting by pressing keys 1 through 4. (Press the DISPLAY key to switch back from setting mode to run mode.)

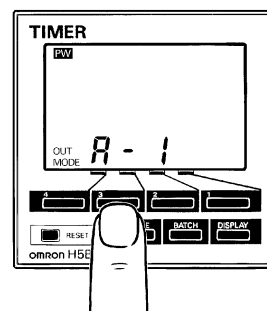

■ Timing Charts

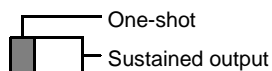
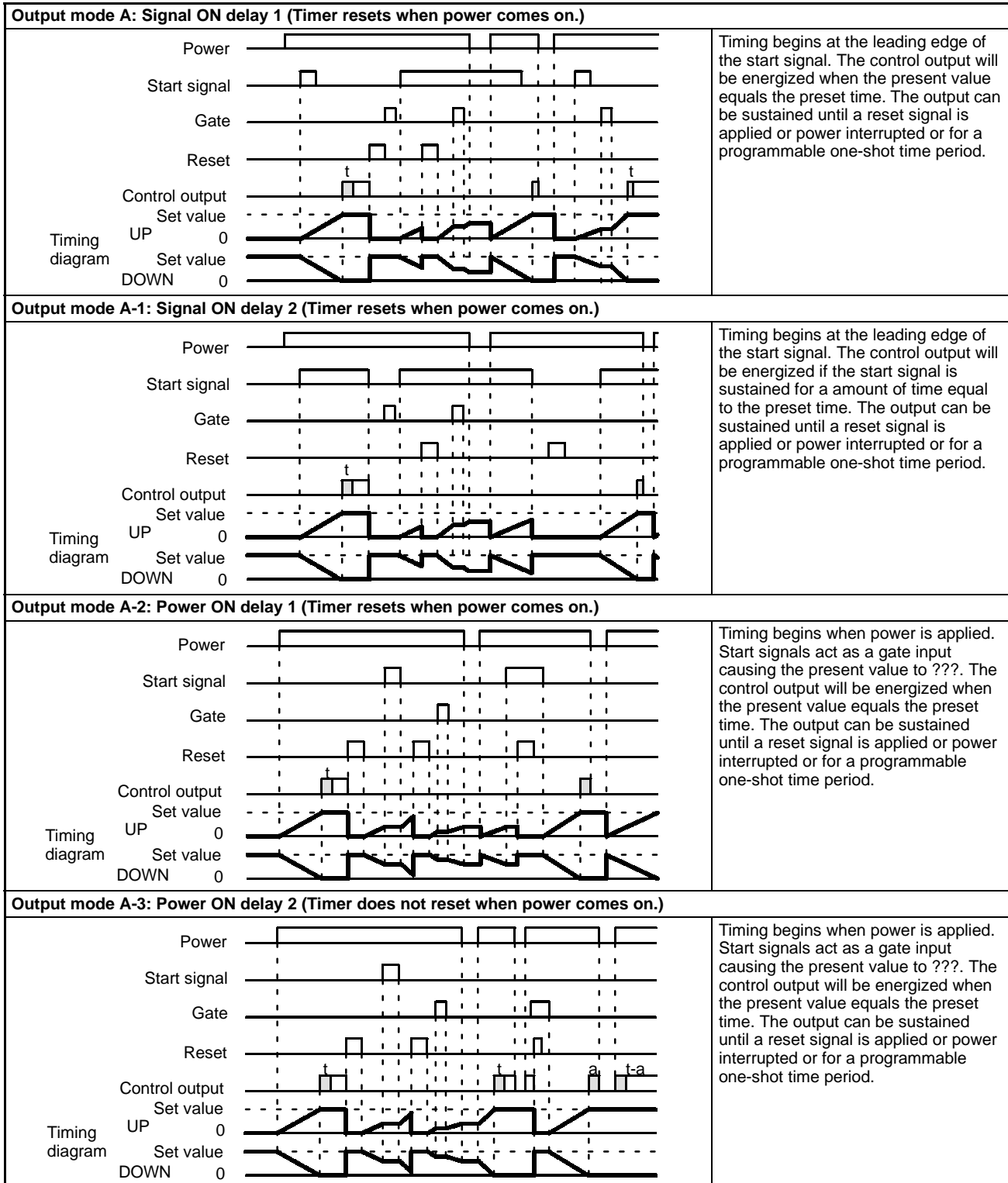

One-shot outputs can be set from 0.1 s to 99.9 s.

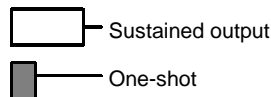
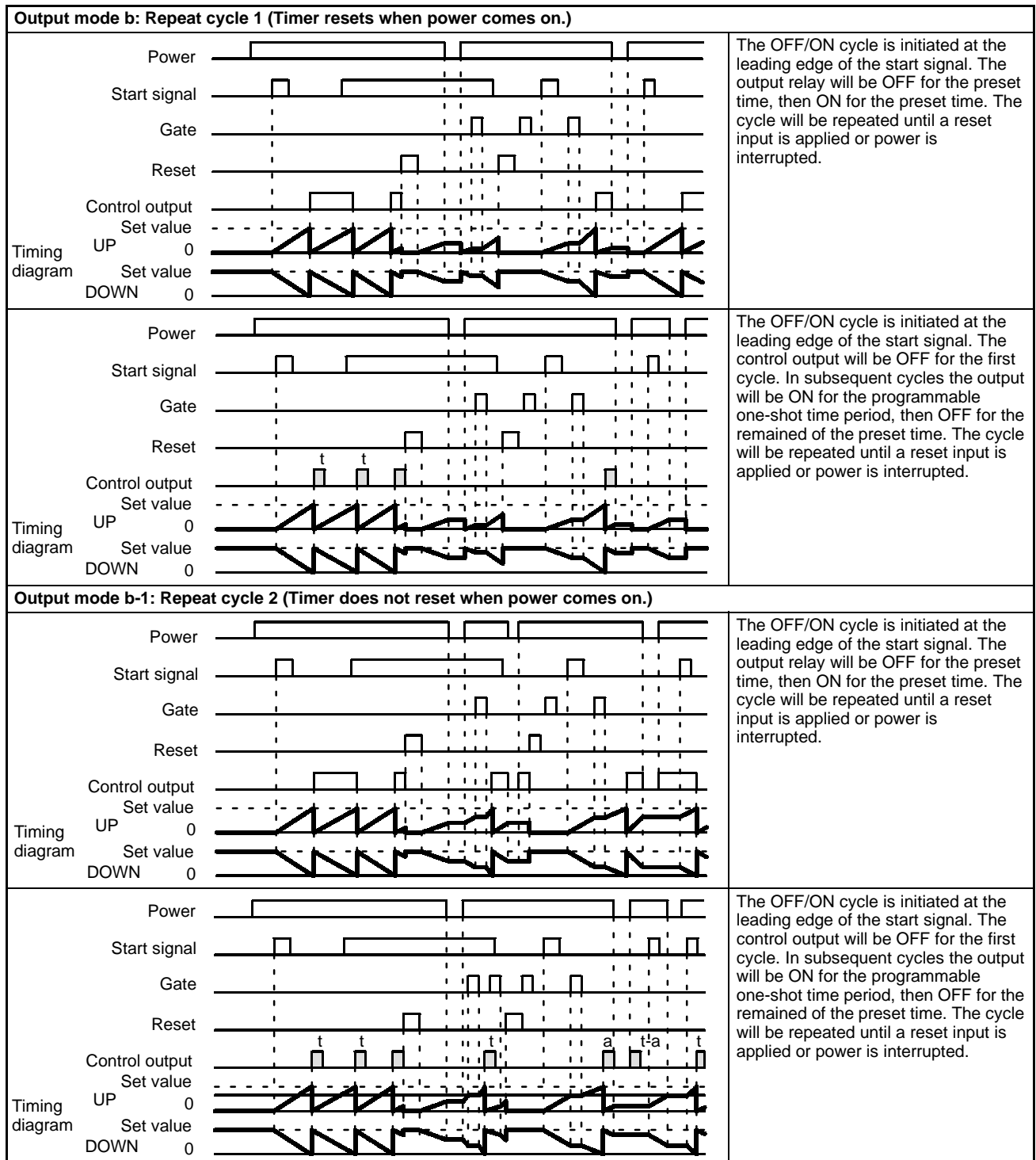

One-shot outputs can be set from 0.1 s to 99.9 s.

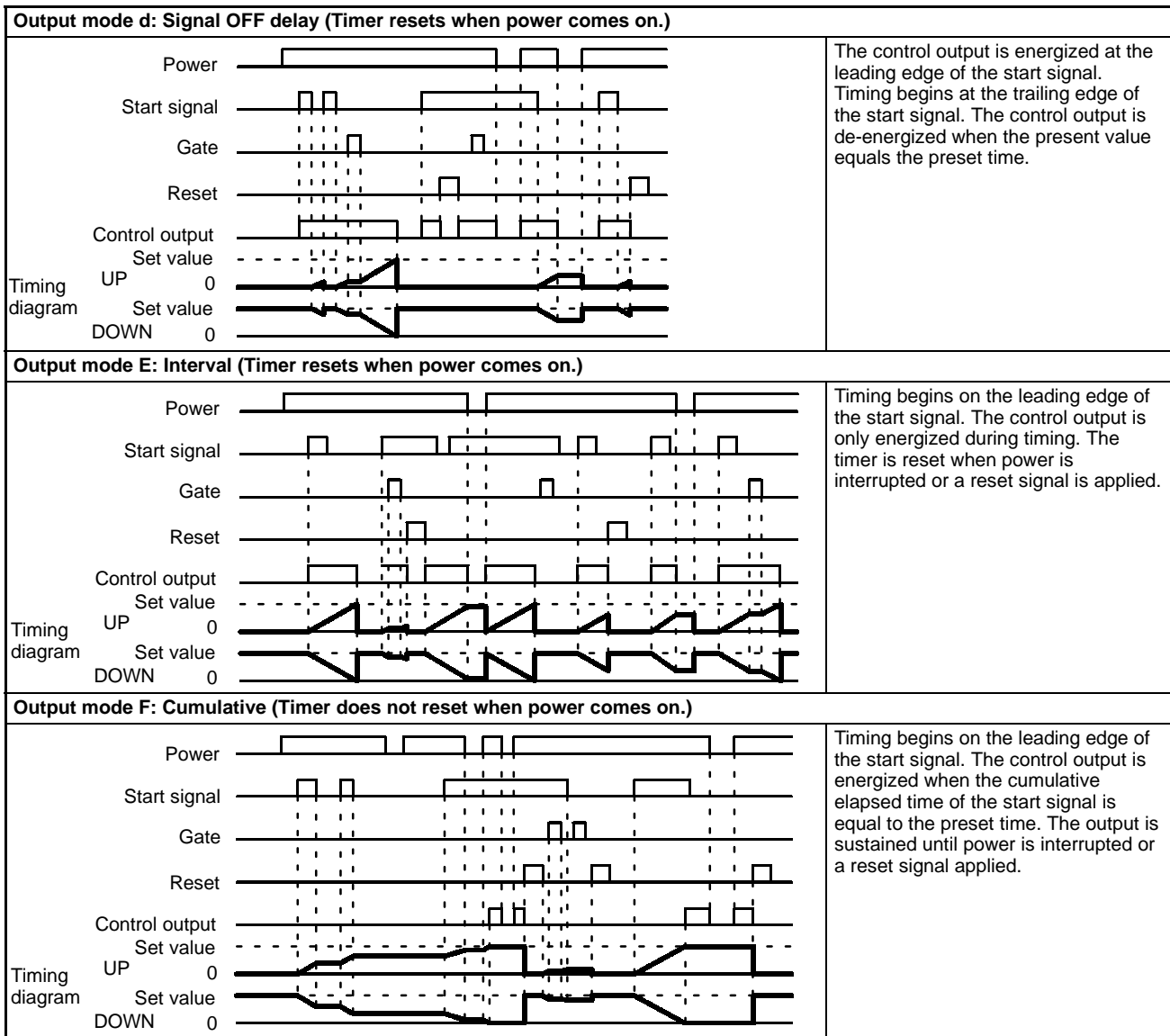

■ Batch Counter Operation

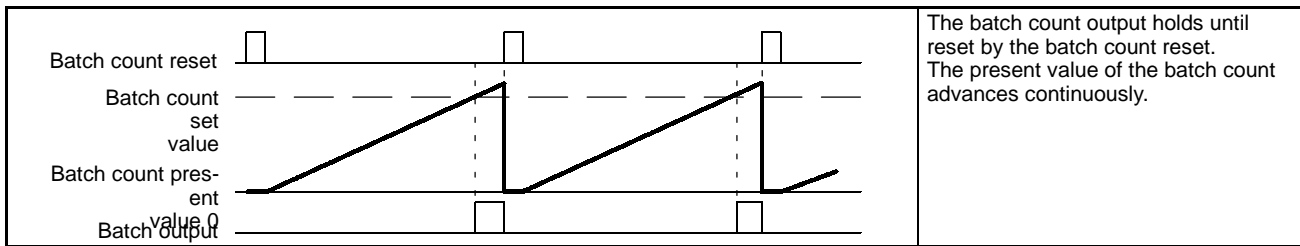

1. The batch count present value remains at 0 while the batch count reset is ON.
2. When the batch count set value is 0, the batch count will proceed, but there will be no output.
3. When the batch count present value exceeds 9999, it returns to 0.
4. The batch count present value and output are not affected by RESET key or reset input.
5. When power is interrupted and the batch count output is ON, the output will be ON when power returns.
6. When a batch count set value which is greater than the present value is changed to a set value which is less than the present value, the output will go ON.
7. If, after the output has gone ON, the set value is changed to a set value which is greater than the present value, the output will remain ON.
8. In the Flicker 1, 2 output hold modes, the number of completed timing is double the number of outputs. To control the number of outputs, set the batch count set value at double the desired number of outputs.

# Dimensions

**Note:** All units are in millimeters unless otherwise indicated.

## H5BR

### Flush Mounting

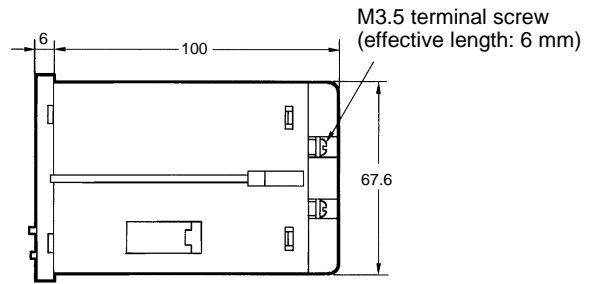
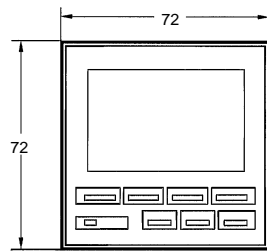
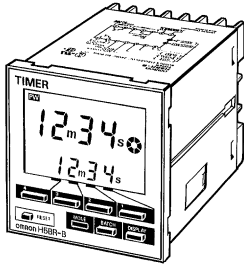

### Flush Mounting Adaptor

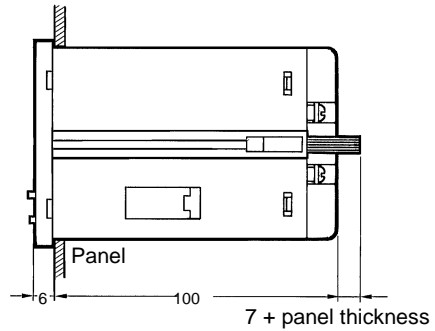
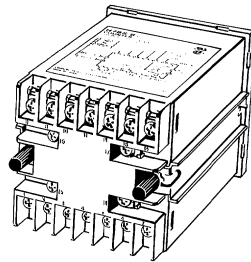
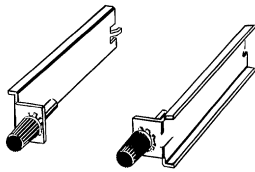

### Panel Cutouts

Panel cutouts are as shown at right. (according to DIN43700).

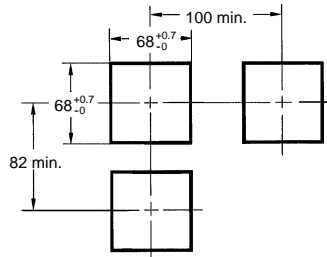

# Installation

## Terminal Arrangement

**H5BR-B (Standard)  
Contact and  
Transistor outputs**

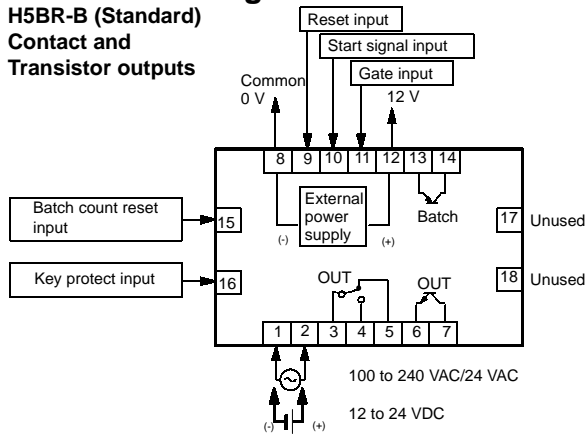

**Note:** Do not connect unused terminals.

## Connections

The inputs of the H5BR are no-voltage (short circuit or open) inputs.

### No-contact Input (NPN Transistor)

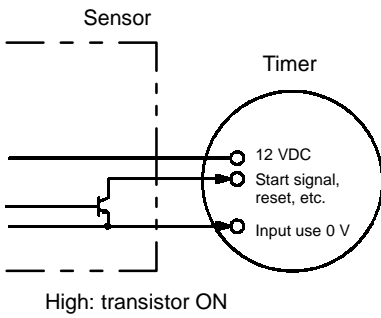

### Contact Input

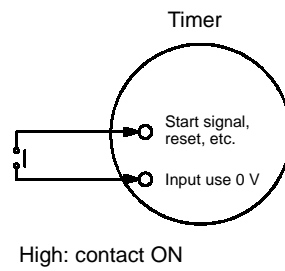

### No-contact Input

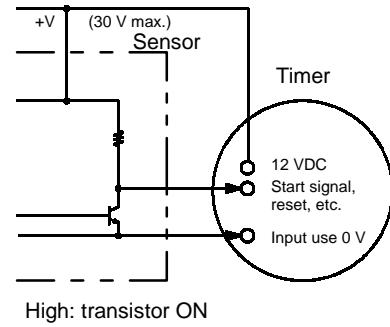

### No-voltage Input Signal Levels

|                  |  |
|------------------|--|
| No-contact input | 1. High level<br>Transistor ON<br>Residual voltage: 2 V max.<br>Impedance when ON: 1 kΩ max. |
|                  | 2. Low level<br>Transistor OFF<br>Impedance when OFF: 100 kΩ min.                            |
| Contact input    | Use contacts which can adequately switch 2 mA at 5 V   |

## Precautions

### External Power Supply

- The capacity of the external power supply is 80 mA at 12 VDC. When using a 24 VAC/12 to 24 VDC power supply, reduce the load with the power supply voltage, as shown in the following diagram (DC power supplies only).

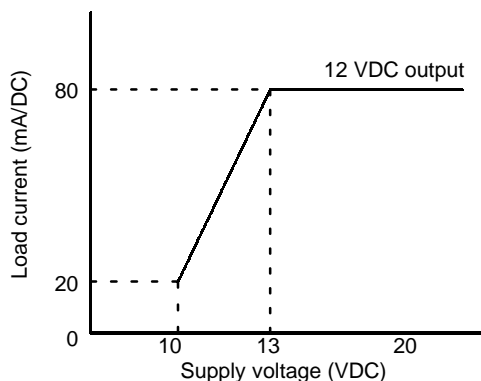

### Power Supplies

- If power is interrupted for less than 10 ms, operation will continue normally. If power is interrupted for between 10 and 500 ms, operation will be inconsistent, and timing may stop or reset, depending on the mode.
- Connect the power supply voltage through a relay or switch in such a way that the voltage reaches a fixed value immediately.
- Depending on switching frequency, current surges may degrade relay contacts; relays with a capacity greater than 10 A are recommended.
- Be sure that the capacity of the external power supply is adequate, because the power supply may not provide a surge current sufficient to start the Timer due to the switching regulator contained in the Timer's internal circuitry.

### Input and Output

- Do not use external sources to increase the voltage of input signals (control signal, reset, gate, and key protection).
- Be sure that the load of the control output (contact, transistor) is less than the maximum values indicated in the specifications. If the output load exceeds the recommended value, the lifespan of the contact output type will be shortened dramatically, and the transistor of the transistor output type will be damaged.
- The transistor output is insulated from the internal circuitry by a photocoupler, so either NPN or PNP transistors can be used.

### Self-diagnostic Function

- The following displays will appear if an error occurs. The present value and output enter the same status as after pressing the RESET key.

| Display | Error  | Output status | Correction         | Setting            |
|---------|--------|---------------|--------------------|--------------------|
| e1      | CPU    | OFF           | Press RESET key    | No change          |
| e2      | Memory |               | (batch count to 0) | Set at the factory |

### Changing Set Values

- The Timer set value can be changed while the timer is operating, so a high value can be set temporarily to inactivate the timer, or a low value can be set to activate the timer more quickly. (If the set value is changed accidentally during operation, the timer might be activated. Therefore, turn the key protection input ON unless the set value is being changed.)
- To avoid changing the output when changing the set value, it is recommended to begin changing the set value by entering a large number in the higher digit.

### Operating Environment

- When using the Timer in an area with much electronic noise, separate the Timer, wiring, and the equipment which generates the input signals as far as possible from the noise sources. It is also recommended to shield the input signal wiring to prevent electronic interference.
- Organic solvents (such as paint thinner), as well as very acidic or basic solutions might damage the outer casing of the Timer.

### Other

- When the timer is installed in a control box and tests are conducted which may damage the Timer's internal circuitry (for example, a test measuring the maximum voltage difference between the control circuit and metal components), remove the Timer from the control box or short circuit the terminals.



#### Caution

This product contains a lithium battery. Lithium batteries explode if incinerated. Dispose of the Digital Timer as a non-combustible item.

**ALL DIMENSIONS SHOWN ARE IN MILLIMETERS.**

To convert millimeters into inches, multiply by 0.03937. To convert grams into ounces, multiply by 0.03527.

Cat. No. L034-E1-2B In the interest of product improvement, specifications are subject to change without notice

## OMRON Corporation

Systems Components Division  
28th Fl., Crystal Tower Bldg.  
1-2-27, Shiromi, Chuo-ku,  
Osaka 540 Japan  
Phone: 06-949-6012 Fax: 06-949-6021

Printed in Japan  
0697-0.5M (0696) a