

New!

OMRON

F210 Vision Sensor

New Application Software Package
Flow Menus and Macro Capability

F210

Reduce the overhead involved
in system planning and introduction.

realizing



New Application Software Package

The Flow Menus and Macros of the F500-UM3FE/UM3ME greatly reduce the design and technical work involved in creating applications.

Application requirements in the production process for inspections, dimension measurements, and positioning have been becoming more varied and complex every year. OMRON has developed a software package to reduce the design and technical work required in creating image-processing applications. With this software package, applications can now be created quickly and simply.



**Use image processing to
create applications.**

**Expanding the limits
of sensing
technology.
Select from a library
of processing items.**

**Flexible combinations
with external device
controls.**

**Design and creation
of processing
algorithms.**

**Easier operation at
the production site.
Reduced learning
time for operations.**

**Original and
specialized menus.
GUI design and
creation.**

**Easier revisions to
specifications added
after introduction.**

This new software package is compatible with the newly released F210, as well as with the high-performance F250 Vision Sensor. The know-how and assets from previously created software can be passed on and developed for other models as well.

The Three Features of Flow Menus and Macros

Flow Menus

Flow Menus select the required processing items from the library, combining and linking them for you.

Ideal for the following:

- Stabilize measurement images by filtering the required number of times.
- Perform measurements according to workpiece tolerance by changing the measurement area based on measurement results.
- Periodically check for data variations by outputting the maximum and minimum values for each 10 measurements.

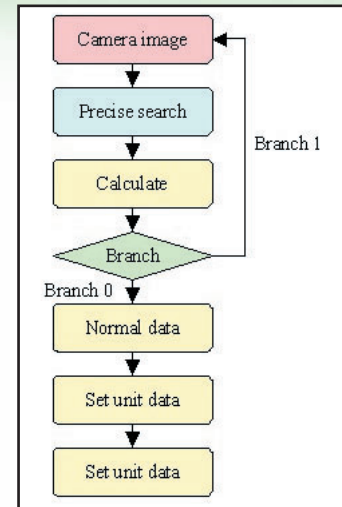
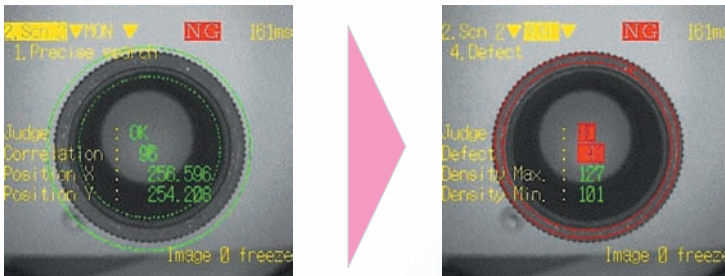

Macros

Augment Flow Menus using a PC text editor. The software package can be edited using text commands to customize I/O controls, displays, and a GUI.

Programs can be created using only a text editor, with no need for any special development environment.

Ideal for the following:

- Creating special menus.
- Displaying and outputting the date and time of NG measurements.
- Automatically saving NG images to a Memory Card.
- Changing the number of registered product types.

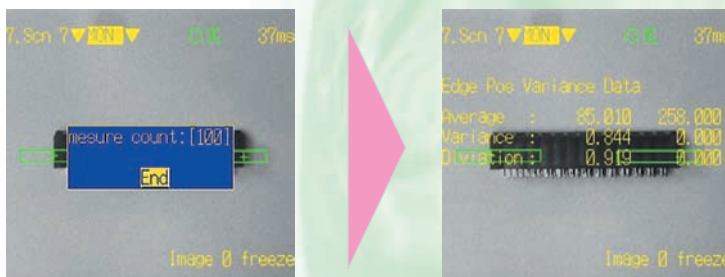

Special menus using macros

Customization Manual

The know-how from the past is incorporated in a manual so that Reverse Customization can be used to determine the best method to execute the desired process.

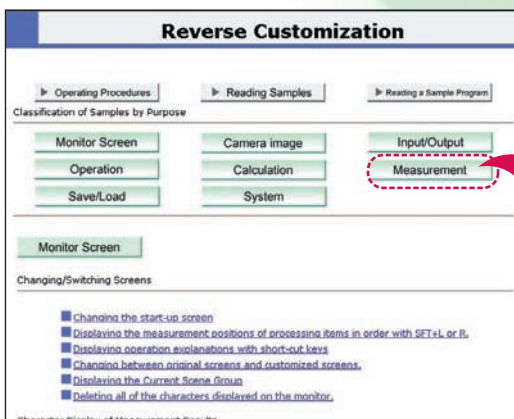

● Building Flow Menus and Using Macros

When an item is selected for operation, a sample program and explanation are displayed. Multiple samples can be easily combined.

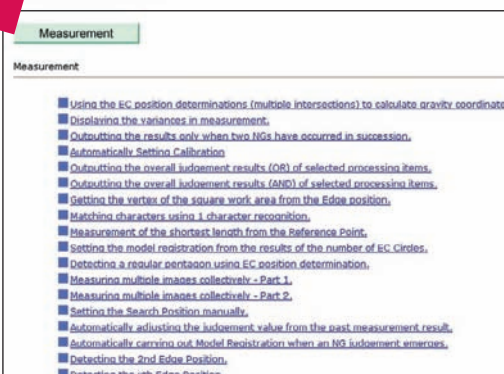

Measurement Processing Item Support

The F500-UM3FE (UM3ME) Application Software supports approximately 70 different processing items. These can be freely combined for inspections as needed. Image input, measurement support, branch control, results output, and results display can be used in common for all of the models (F210, F250, F270, and F500).

Image Input Functions

- Inputting Camera Images
- Switching Cameras
- Changing Filtering
- Filtering Again







Position Compensation Functions

YES: Supported NO: Not supported







Compensation	Processing item	Controller				Remarks
		F210	F250	F270	F500	
	Binary Position Compensation	YES	YES	YES	YES	---
	Circle Position Compensation	NO	YES	YES	NO	---
	EC Position Compensation	YES	YES	YES	YES	---
	Edge Position Compensation	YES	YES	YES	YES	---
	Model Position Compensation	NO	YES	YES	NO	Enables high-speed processing compared to the model position compensation #.
	Model Position Compensation #	YES	YES	YES	YES	---

General Measurement Functions

YES: Supported NO: Not supported

Application (measurement)	Processing item	Controller				Remarks	
		F210	F250	F270	F500		
Size (area) 	Binary Defect	YES	YES	YES	YES	Up to eight regions can be set per Unit, with results displayed in a list.	
	Binary Gravity and Area	YES	YES	YES	YES	Only one region can be set per Unit. Menu levels are simple and easy to understand.	
	Binary Area (Variable Box)	YES	YES	YES	YES	Used for inspecting measurement items with varying positions and sizes.	
Position Center-of-gravity detection (Processing time: Low)  Coordinate detection (Processing time: High)  Coordinate detection (Rotation in measurement item)  Dimensions measurement  Dimensions measurement (inclined edge)  Position deviation detection 	Binary Defect	YES	YES	YES	YES	Up to eight regions can be set per Unit, with results displayed in a list.	
	Binary Gravity and Area	YES	YES	YES	YES	YES	Only one region can be set per Unit. Menu levels are simple and easy to understand.
	Binary Area (Variable Box)	YES	YES	YES	YES	YES	Used for inspecting measurement items with varying positions and sizes.
	Gray Search	YES	YES	YES	YES	YES	Uses gray models to detect positions in pixel units.
	Precise Search	YES	YES	YES	YES	YES	Uses gray models to detect positions in sub-pixel units.
	Flexible Search	YES	YES	YES	YES	YES	Multiple models are registered to enable searching even when there is variation.
	Pattern	NO	YES	YES	NO	NO	Up to 64 regions can be registered per Unit, and high-speed processing is possible. (See note.)
	ECM Search	YES	YES	YES	YES	YES	Uses edge code models so that processing is not affected by deformation or dirt.
	EC Positioning	YES	YES	YES	YES	YES	No model registration is required. Searches using shape information such as "round" or "angular."
Rotation Positioning	NO	YES	YES	NO	NO	High-speed processing is possible. (See note.)	
Rotation Search	YES	YES	YES	YES	YES	---	
Gray Edge Position_8	YES	YES	YES	YES	YES	Up to eight regions can be set per Unit, with results displayed in a list.	
Gray Edge Position_1	YES	YES	YES	YES	YES	Only one region can be set per Unit. Menu levels are simple and easy to understand.	
Gray Edge Width	YES	YES	YES	YES	YES	---	
Inclination Direction Gray Edge	YES	YES	YES	YES	YES	The inclination direction area can be set. Comparison with the gray edge position will lengthen processing time.	
Relative Position	YES	YES	YES	YES	YES	---	

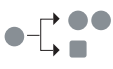
Note: These processing items are most effective when set immediately after image input processing item (Camera image input or Camera switching). Depending on conditions, however, high-speed processing may not be possible.

Application (measurement)	Processing item	Controller				Remarks
		F210	F250	F270	F500	
Defect 	Surface Defect	YES	YES	YES	YES	Only one region can be set per Unit. Menu levels are simple and easy to understand.
	Density Defect	NO	YES	YES	NO	Up to eight regions can be set per Unit, with results displayed in a list. The number of Units can be reduced.
	Surface Defect (Variable Box)	YES	YES	YES	YES	Used for inspecting measurement items with varying positions and sizes.
	EC Defect	YES	YES	YES	YES	Uses edge codes for defect inspection so that processing is not affected by deformation or dirt.
	Fine Matching	YES	YES	YES	YES	Accurately detects differences with models.
	Density Defect #	YES	YES	YES	YES	Used to delete deviation defect function from density defect inspection. Can also be used with Sensors other than F250 and F270.
	EC Circle Defect	YES	YES	YES	YES	Used to detect defects in complicated backgrounds such as dents.
Characters ABC	QUEST Character Verification	YES	YES	YES	YES	Used to verify multiple characters.
	Lot Number OCR 1	YES	YES	YES	YES	Handles lot numbers that are changed daily, weekly, monthly, or annually.
	OCR for 1 Character	YES	YES	YES	YES	---
Application-specific	BGA Search	YES	YES	YES	YES	Measurement processing items specific to applications and work-pieces.
Angle 	Binary Defect	YES	YES	YES	YES	Up to eight regions can be set per Unit, with results displayed in a list. The number of Units can be reduced.
	Binary Gravity and Angle	YES	YES	YES	YES	Only one region can be set per Unit. Menu levels are simple and easy to understand.
	Rotation Positioning	NO	YES	YES	NO	High-speed processing is possible. (See note.)
	Rotation Search	YES	YES	YES	YES	Used when the measurement item rotates.
	Circular Angle	YES	YES	YES	YES	Used only for circular measurement items. Enables higher-speed processing compared to Rotation Search. (See note.)
Quantities 	Labeling	YES	YES	YES	YES	Counts up to 2,500. (Up to 10,000 for the F500)
	Label Data	YES	YES	YES	YES	Gets label measurement values from other Units.
	Edge Pitch	YES	YES	YES	YES	Gets the number, pitch, and width.
	EC Circle Count	YES	YES	YES	YES	Finds circles using "round" shape information so that processing is not affected even if the circles are deformed or dirty.
Shapes (correlation values) 	Pattern	NO	YES	YES	NO	Up to 64 regions can be registered per Unit, enabling high-speed processing. (See note.)
	Flexible Search	YES	YES	YES	YES	Searching can be performed even if there is variation in model images.
	Fine Matching	YES	YES	YES	YES	Accurately detects differences with models.
Classification 	Classification	NO	YES	YES	NO	Enables higher-speed processing compared to Classification #. (See note.)
	Classification #	YES	YES	YES	YES	---
Brightness 	Density Data	YES	YES	YES	YES	---

Note: These processing items are most effective when set immediately after image input processing item (Camera image input or Camera switching). Depending on conditions, however, high-speed processing may not be possible.

Measurement Support Functions

- Calculation
- Get unit data
- Set unit data
- Wait
- Elapsed time
- Trend monitor

Results Output Functions

- Memory card data output
- DO data output
- Host link data output
- Normal data output
- DO judgement output

Branch Control Functions

- Conditional branch
- DI branch
- End

Results Display Functions

- String display
- Measurement display
- Judgement display
- Item display
- Time display
- Figure display
- Line results display
- Box display
- Circle display
- Cursor display
- Newest NG image display

System Configuration

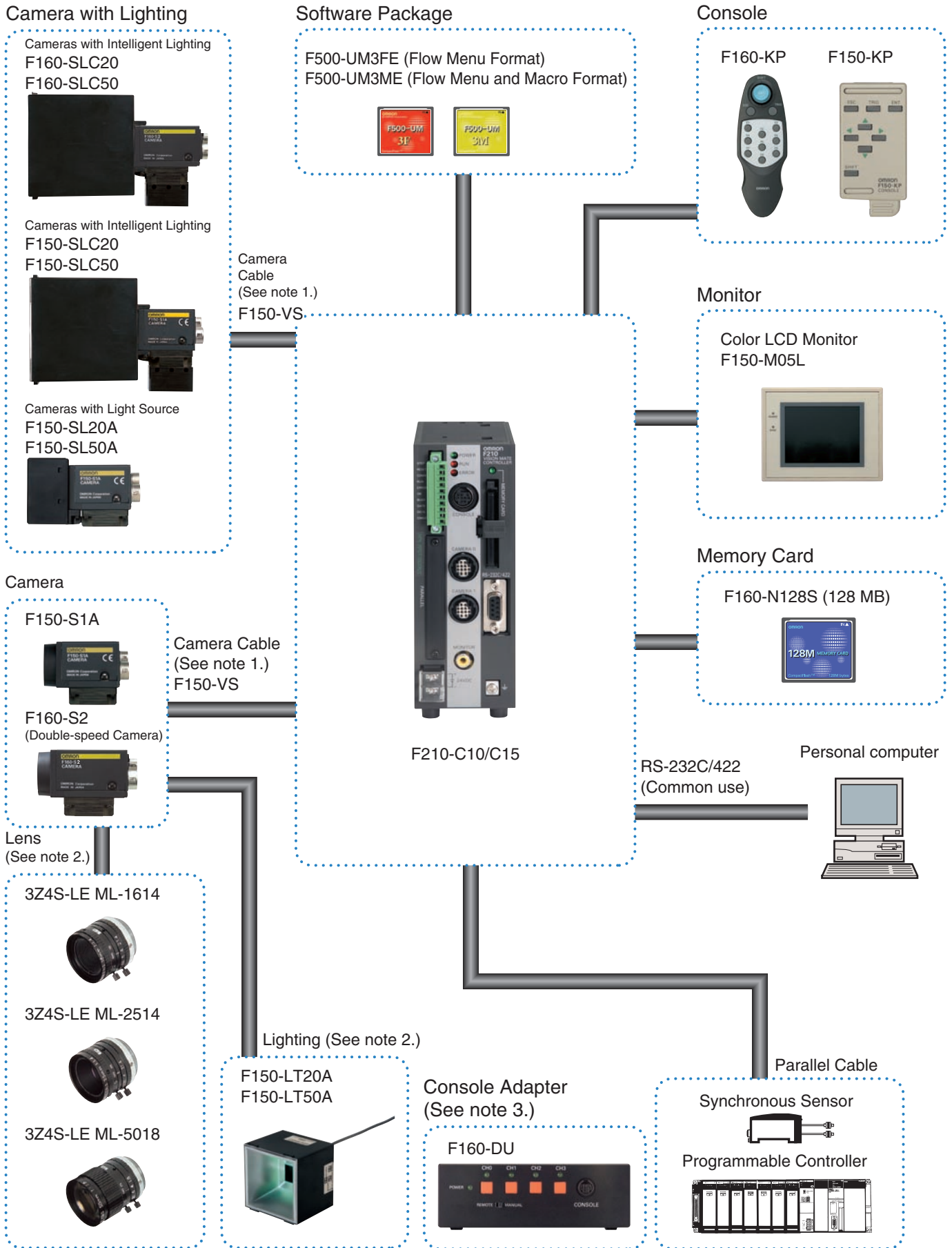

Note 1: Separate robot cable specifications (F150-VSB) are available.

Note 2: In addition, lenses and lighting are available.

Note 3: This is a special optional device that allows multiple Controllers to be operated with a single Monitor and Console. Please inquire for details.

Ratings and Performance

Controller

Item	Specifications	F210-C10/C15
Connectable Cameras		F150-S1A/-SL20A/-SL50A/-SLC20/-SLC50, F160-S2/-SLC20/-SLC50, etc.
Number of Cameras connectable		2
Number of pixels		512 × 484 (H × V)
Number of scenes		32 (Expansion possible using Memory Cards.)
Image storage function		Maximum of 35 images stored
Filtering		Smoothing (strong, weak), edge enhancement, edge extraction (horizontal, vertical, both), dilation, erosion, median, background suppression
Operation and settings		Installing measurement items using application software, and combining and setting measurement items by menu operations
Menu language		Japanese or English (Can be switched.)
Trend monitor function		Supported
Memory card slots		1
Monitor interface		1 channel
Ethernet		Not supported.
Serial communications		RS-232C/422A: 1 channel
Parallel I/O		13 inputs and 23 outputs
Strobe interface		2 channels (included in parallel outputs)
Power supply voltage		20.4 to 26.4 VDC
Current consumption		Approx. 1.6 A (when two F160-SLC50 Cameras are connected)
Ambient temperature		Operating: 0 to 50°C Storage: -25 to 65°C (with no icing or condensation)
Ambient humidity		Operating and storage: 35% to 85% (with no condensation)
External dimensions		56 × 160 × 110 (W × H × D) mm (not including connectors and other protruding parts)
Weight		Approx. 570 g (Controller only)

Dimensions

Unit: mm

Controller F210-C10/C15

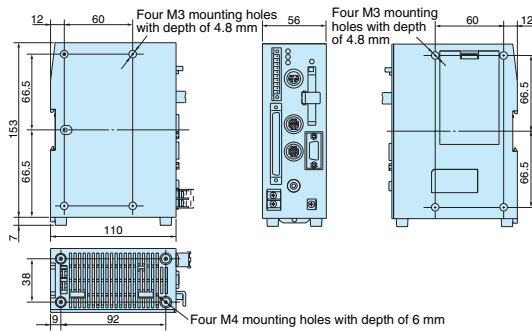

Camera F160-S2

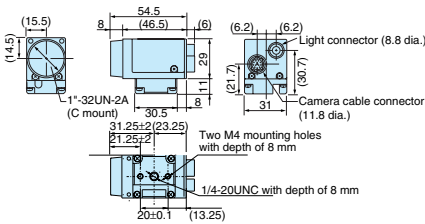

Console F160-KP

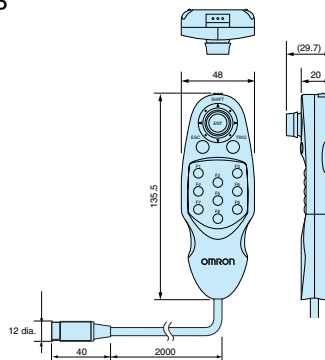

Liquid Crystal Monitor F150-M05L

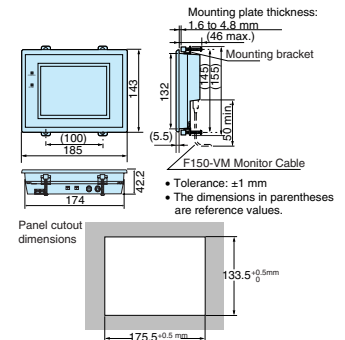

Introducing OMRON Vision Sensors

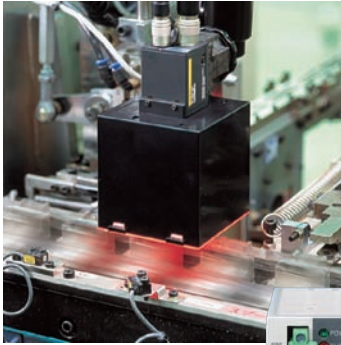

Can also be easily introduced to ultra high-speed processing lines.

- Images from the F160-S2 Double-speed Camera are input up to 4 times faster than conventional OMRON products.
- Inspection functions (gray searches, detection of scratches, soiling, etc.) are 2 to 10 times faster than previous OMRON products.

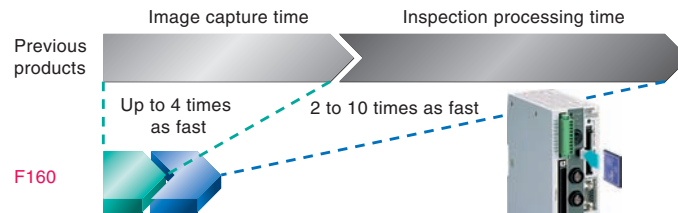

Equipped with a Memory Card

- Allows easy use on multi-product lines by simply increasing the number of scenes.

Customize function allows the F160 to be tailored to specific production needs.

- Shortcut keys
- Password setting
- Screen message customization on measurement screens, color displays, and much more.

F160 Vision Sensor

For details, refer to the F160 Vision Sensor (catalog No. Q133-E1-□)

This document provides information mainly for selecting suitable models. Please read the Setup Manual (SCHB-738) carefully for information that the user must understand and accept before purchase, including information on warranty, limitations of liability, and precautions.

OMRON Corporation Industrial Automation Company

**Sensing Devices Division H.Q.
Application Sensors Division**
Shiokoji Horikawa, Shimogyo-ku,
Kyoto, 600-8530 Japan
Tel: (81)75-344-7068
Fax: (81)75-344-7107

Regional Headquarters

OMRON EUROPE B.V.
Sensor Business Unit, Carl-Benz-Str. 4,
D-71154 Nufringen, Germany
Tel: (49)7032-811-0/Fax: (49)7032-811-199

OMRON ELECTRONICS LLC
1 East Commerce Drive, Schaumburg, IL 60173 U.S.A.
Tel: (1)847-843-7900/Fax: (1)847-843-8568

OMRON ASIA PACIFIC PTE. LTD.
83 Clemenceau Avenue, #11-01, UE Square,
239920 Singapore
Tel: (65)6835-3011/Fax: (65)6835-2711

OMRON (CHINA) CO., LTD.
Room 2211, Bank of China Tower,
200 Yin Cheng Road (M), Shanghai, 200120 China
Tel: (86)21-5037-2222/Fax: (86)21-5037-2200

Authorized Distributor: