

## V700-series

### Electromagnetic Inductive RFID System

- ID Tag **V700-D23P31 (Coin-shaped)**
- Antenna **V700-H01 (Standard Antenna)**      **V700-H02 (Wide-field Antenna)**
- Controller **V700-CD1D (One-channel Controller)**



#### ID TAG



V700-series RFID System with a 125-kHz carrier frequency and read/write function provides the industry's highest functionality and performance.

#### ANTENNA

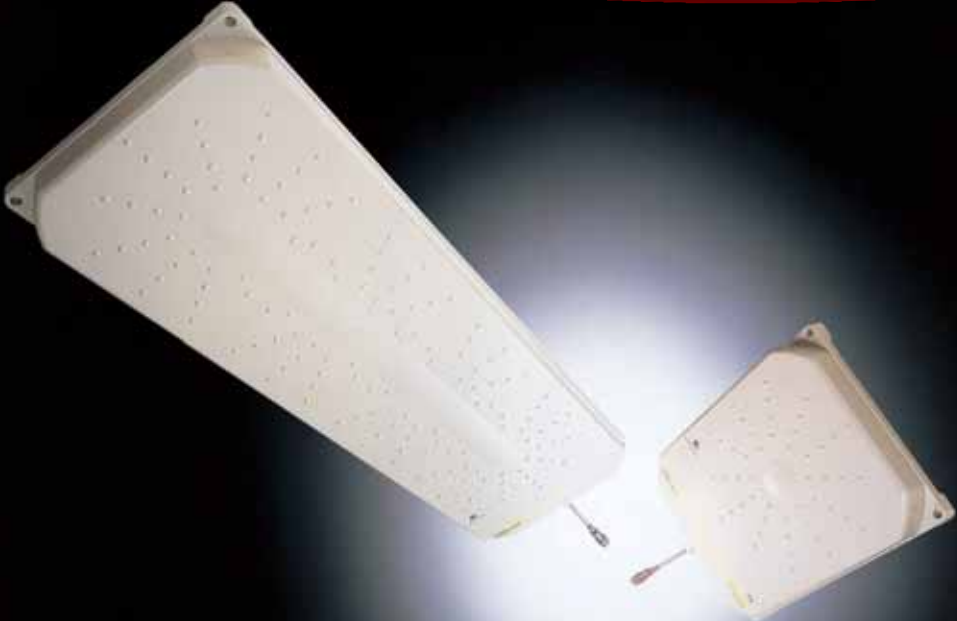

#### CONTROLLER

**V700** **ANTENNA + CONTROLLER + ID TAG** **SERIES**

## High Functionality and High Performance

- Provides the industry's highest communications speed, longest transmission distance, and highest security among models in this class.
- Variety of built-in functions ideal for a wide range of applications. The industry's first model in this class with multiple, simultaneous access and FIFO (first-in first-out) functions.
- Variety of monitoring functions allowing Antennas and ID Tags to be installed within an optimum environment. (Communications test, noise environmental measurement, error logging, and communications condition monitoring functions.)
- Bears CE markings to meet EN standards and is FCC approved.



## Highly Heat Resistant and Environment Resistant

- Coin-shaped Tags are highly heat resistant and store data for 200 hours at 180°C.
- Coin-shaped Tags are tough, environment-resistant, and washable.
- A wide variety of compact Thin Tags is available for enclosed-mounting.



# High Functionality of the V700 Allows a Wide Range of Applications

## ■ Control of Uniforms

- Uniforms can be automatically sorted by size, delivery destination, etc., by reading data input to the ID Tags.
- Detailed quality control can be performed by writing the number of cleaning times or repair history.

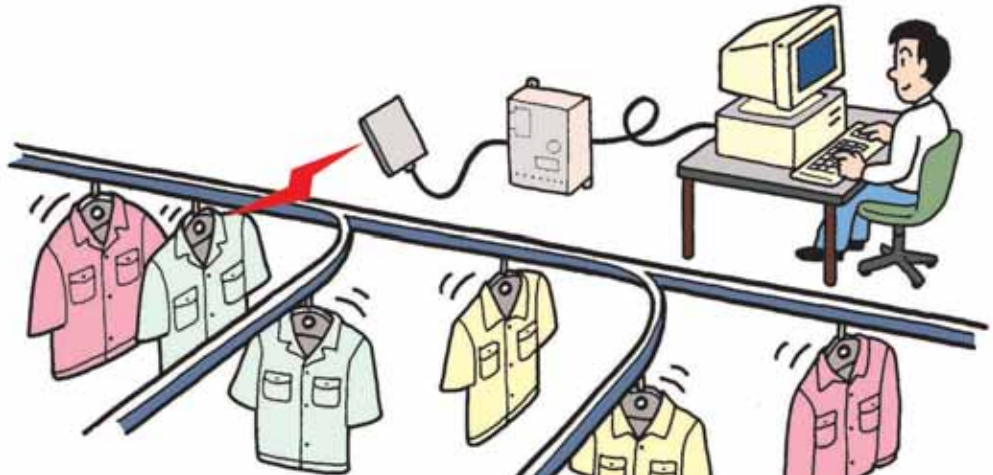

■ FIFO (first-in first-out) function

## ■ Collecting by Ticket Type at a Ski Resort

- The V700 System can be used for counting the number of skiers at a gate according to the type of ticket (one-day ticket, coupon ticket, etc.).



## ■ Mailbox Control

The V700 System can be used for individual control of mailboxes for an apartment building.

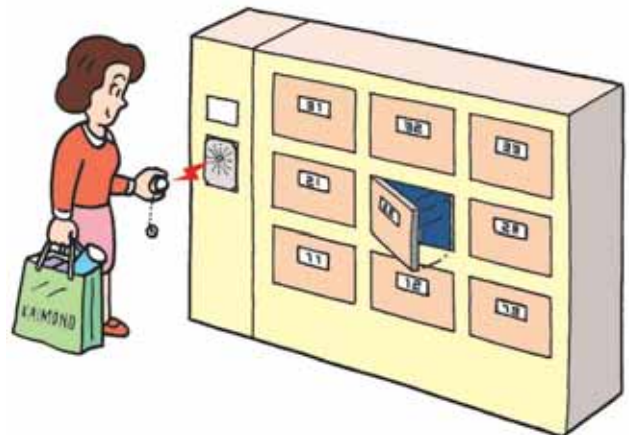

## ■ Sorting

Automatic sorting can be performed by reading the ID codes on ID Tags.

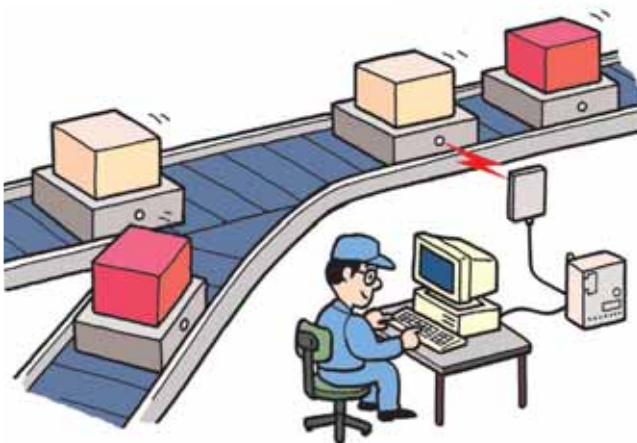

## ■ Cafeteria POS

By attaching ID Tags to dishes and imbedding price look-up data, the total price can be calculated automatically.



■ Simultaneous access to more than one Tag (1:N read/write)

# Electromagnetic Inductive RFID System V700







## A High-functionality High-performance RFID System That Revolutionizes Product and Distribution Management in the Production Environment

- A long transmission distance and a wide transmission range allow position displacement and axial offset of ID Tags to be handled with ease.
- Reading and writing are possible with several ID Tags in the Antenna's transmission range, allowing use in new applications.
- Easy-to-use, reasonably-priced ID Tags enable the creation of low-cost systems even in applications using a large number of Tags.
- A Compact Reader Writer, the V700-HMD11(-1), is now available.
- The lineup includes an ID Link Unit that is compatible with multi-drop connections and RS-485 interfaces.
- The V700-HMD11-1 Compact Reader Writer can be connected directly to the ID Link Unit or an OMRON PLC without an AC Adapter.
- CE marking (except for V700-H02).
- FCC approvals and R&TTE Directive compliance (except for V700-H02).











## Ordering Information

### ■ List of Models



Name	Model	Model	Specifications/Design
ID Tag	V700-D23P31		20 dia. × t 2.7 mm Coin-shaped 256 bytes (with user area of 240 bytes)
	V700-D23P41		3.9 dia. × 25 mm Stick-shaped 256 bytes (with user area of 240 bytes)
	V700-D23P61		40 × 40 × 4.5 mm Square tag 256 bytes (with user area of 240 bytes)
ID Tag Holder	V700-A80		Special holder for the V700-D23P31 (There is no ID Tag provided with the product.)
Antenna	V700-H01 (Standard Antenna)		250 × 200 × 35 mm 100-mm cable
	V700-H02 (Wide-field Antenna)		650 × 200 × 35 mm 100-mm cable





Name	Model		Specifications/Design	
Controller	V700-CD1D-V3		90 × 65 × 75 mm	RS-232C interface 24 VDC, 1 channel for Antenna connection
	V700-CD2D-V3			RS-485 interface Maximum number of Controllers that can be connected: 31 24 VDC, 1 channel for Antenna connection
Antenna Cable	V700-A40		2 m	Material: Vinyl chloride The connector is not waterproof.
	V700-A41		3 m	
	V700-A42		5 m	
	V700-A43		10 m	
	V700-A44		20 m	
	V700-A45		30 m	
Compact Reader Writer	V700-HMD11		40 × 53 × 23 mm	RS-232C interface 5 VDC supplied via AC Adapter 2-m cable
	V700-HMD11-1			RS-232C interface 5 VDC supplied from connector
				1-m cable
				2-m cable
				4-m cable
ID Link Unit	V700-L12		110 × 65 × 64 mm	RS-232C and RS-485 interface Unit for multiple connections
AC Adapter	V600-A20			AC Adapter for V700-HMD11
Programming Console	C200H-PRO27-E			Equipped with the following functions: Execution status monitor, set value display, transmission execution, transmission test, noise measurement, reading error contents
Programming Console Connecting Cable	V700-P10		2 m	Cable for connecting the V700-CD□D-V□ and C200H-PRO27-E



## Specifications

### ■ ID Tags



Item	Model		
	V700-D23P31 	V700-D23P41 	V700-D23P61 
Memory capacity	240 bytes (user area)	240 bytes (user area)	240 bytes (user area)
Memory type	EEPROM		
Data backup time	10 years after data written		
Data writing times	100,000 times per address		
Ambient operating temperature (during transmission)	-20 to 70°C (with no icing)	-25 to 70°C (with no icing)	-10 to 70°C
Ambient operating temperature (not during transmission)	-40 to 110°C (with no icing) Heat resistance: Constant high temperature: 180°C for 200 hours Thermal cycle: 25°C/180°C, 30 minutes, 200 cycles	-40 to 110°C (with no icing)	-10 to 70°C (with no icing)
Ambient storage temperature	-40 to 110°C (with no icing)	-40 to 110°C (with no icing)	-10 to 70°C (with no icing)
Ambient operating humidity	No restrictions	35% to 95% (with no condensation)	35% to 85%
Degree of protection	IEC 60529: IP68	IEC 60529: IP67	IP67 (IEC 60529 standard)
Vibration resistance	10 to 2,000 Hz, 0.75-mm single amplitude, 150-m/s <sup>2</sup> acceleration with 10 sweeps of 15 min each in X, Y, and Z directions		10 to 2,000 Hz, 1.5-mm single amplitude, 150-m/s <sup>2</sup> acceleration with 10 sweeps of 15 min each in X, Y, and Z directions
Shock resistance	500-m/s <sup>2</sup> acceleration for 3 times each in X, Y, and Z directions (18 times in total)		500-m/s <sup>2</sup> acceleration for 3 times each in 6 directions, front/back, up/down, and left/right (18 times in total)
Material	PPS resin	Case: PBT resin; Filling: Epoxy resin	Case: ABS; Filling: Epoxy resin
Weight	Approx. 2 g	Approx. 1 g	Approx. 6 g

### ■ Controllers



Item	Model	
	V700-CD1D-V3 	V700-CD2D-V3 
Host interface	RS-232C	RS-485 (Up to 31 Controllers can be connected.)
Number of connectable Antennas	1	
Power supply voltage	24 VDC +10%/-15%	
Power consumption	20 W max.	
Insulation resistance	20 MΩ min. (at 100 VDC) between the power supply terminals and ground terminal, power supply terminals and I/O terminals, power supply terminals and case, I/O terminals and ground terminal, I/O terminals and case, and ground terminal and case	

Item	Model	
	V700-CD1D-V3 	V700-CD2D-V3 
Dielectric strength	500 VAC (50/60 Hz, 1 minute) between the above terminals (leakage current: 10 mA max.)	
Vibration resistance	10 to 150 Hz, 0.30-mm double amplitude with 4 sweeps of 8 min each in X, Y, and Z directions	
Shock resistance	200-m/s <sup>2</sup> acceleration for 3 times each in X, Y, and Z directions (18 times in total)	
Ambient operating temperature	-10 to 55°C (with no icing)	
Ambient operating humidity	35% to 85% (with no condensation)	
Ambient storage temperature	-25 to 65°C (with no icing)	
Ambient storage humidity	35% to 95% (with no condensation)	
Degree of protection	IEC 60529: IP30 (panel mounted)	
Ground	Ground at a resistance of less than 100 Ω. If grounding is not performed properly, transmission specifications may be adversely affected by the surrounding environment.	
Weight	Approx. 290 g	

■ Antennas

Item	Model	
	V700-H01 	V700-H02 
Oscillation frequency	125 kHz	
Insulation resistance	20 MΩ min. (at 500 VDC) between the cable terminals and the case	
Dielectric strength	1,000 VAC (50/60 Hz, 1 minute) between the cable terminals and the case (leakage current: 1 mA max.)	
Vibration resistance	10 to 150 Hz, 1.50-mm double amplitude with 2 sweeps of 8 min each in X, Y, and Z directions	
Shock resistance	300-m/s <sup>2</sup> acceleration for 3 times each in X, Y, and Z directions (18 times in total)	
Ambient operating temperature	-20 to 55°C (with no icing)	
Ambient storage temperature	-35 to 65°C (with no icing)	
Ambient operating humidity	35% to 85% (with no condensation)	
Ambient storage humidity	35% to 95% (with no condensation)	
Degree of protection	IEC 60529: IP40 (except connector)	
Material	Case: PC/ASA resin; Rear panel: Phenol resin; PVC (The connector is not resistant to water or oil.)	
Cable length	Maximum connection distance: 50.1 m using extension cable.	
Weight	Approx. 800 g	Approx. 1,760 g

## ■ Compact Reader Writers

Item	Model	
	V700-HDM11 	V700-HMD11-1 
<b>Host interface</b>	RS-232C	
<b>Power consumption</b>	5 VDC ±5% (supplied via V600-A20 AC Adapter) Oscillating: 200 mA max.; Not oscillating: 25 mA max.	5 VDC ±5% (supplied via connector) 250 mA max.
<b>Insulation resistance</b>	50 MΩ min. (at 500 VDC) between the cable terminals and the case	
<b>Dielectric strength</b>	1,000 VAC (50/60 Hz, 1 minute) between the cable terminals and the case (leakage current: 1 mA max.)	
<b>Vibration resistance</b>	10 to 150 Hz, 1.50-mm double amplitude with 4 sweeps of 8 min each in X, Y, and Z directions	
<b>Shock resistance</b>	300-m/s <sup>2</sup> acceleration for 3 times each in X, Y, and Z directions (18 times in total)	
<b>Ambient operating temperature</b>	-10 to 55°C (with no icing)	
<b>Ambient operating humidity</b>	25% to 85% (with no condensation)	
<b>Ambient storage temperature</b>	-25 to 65°C (with no icing)	
<b>Ambient storage humidity</b>	25% to 95% (with no condensation)	
<b>Degree of protection</b>	IEC 60529: IP67 The connector is not resistant to water or oil.	
<b>Material</b>	Case: ABS resin; Filling: Epoxy resin; Cable: PVC (oil-resistant)	
<b>Cable length</b>	2 m (RS-232C signal lines can be extended up to a total length of 15 m.)	1, 2, 4 m
<b>Weight</b>	Approx. 210 g	Approx. 210 g (2 m)



■ ID Link Unit

Item	V700-L12 
Host interface	RS-232C or RS-485 (special 1:N protocol)
Number of connectable Antennas	1
Power supply voltage	24 VDC +10%/-15%
Power consumption	10 W max.
Insulation resistance	50 MΩ min. (at 500 VDC) between the power supply terminals and the ground terminal
Dielectric strength	1,000 VAC (50/60 Hz, 1 minute) between the power supply terminals and the ground terminal (leakage current: 5 mA max.)
Vibration resistance	10 to 150 Hz, 0.20-mm double amplitude, 15-m/s <sup>2</sup> acceleration with 10 sweeps of 8 min each in X, Y, and Z directions
Shock resistance	150-m/s <sup>2</sup> acceleration for 3 times each in X, Y, and Z directions (18 times in total)
Ambient operating temperature	0 to 40°C (with no icing)
Ambient operating humidity	35% to 85% (with no condensation)
Ambient storage temperature	-15 to 50°C (with no icing)
Ambient storage humidity	35% to 85% (with no condensation)
Degree of protection	IEC 60529: IP20
Ground	Ground at a resistance of less than 100 Ω. If grounding is not performed properly, transmission specifications may be adversely affected by the surrounding environment.
Weight	Approx. 185 g

■ AC Adapter

Item	V600-A20 
Input voltage	85 to 110 VAC, 50/60 Hz
Output voltage	5 VDC ±0.25 V
Insulation resistance	100 MΩ min. (at 500 VDC) between the input terminals and output terminals and between the input terminals and case
Dielectric strength	1,000 VAC (50/60 Hz, 1 minute) between the input terminals and output terminals and between the input terminals and case (leakage current: 3 mA max.)
Ambient operating temperature	-10 to 55°C (with no icing)
Ambient operating humidity	25% to 85% (with no condensation)
Ambient storage temperature	-20 to 70°C (with no icing)
Weight	Approx. 360 g

■ ID Tag Holder (for V700-D23P31 Coin-shaped ID Tag)

Item	V700-A80 
Ambient storage temperature	Conforms to the specifications for the V700-D13P31 Coin-shaped ID Tag.
Ambient operating humidity	No restrictions
Material	PPS resin
Weight	Approx. 5 g

# System Configuration

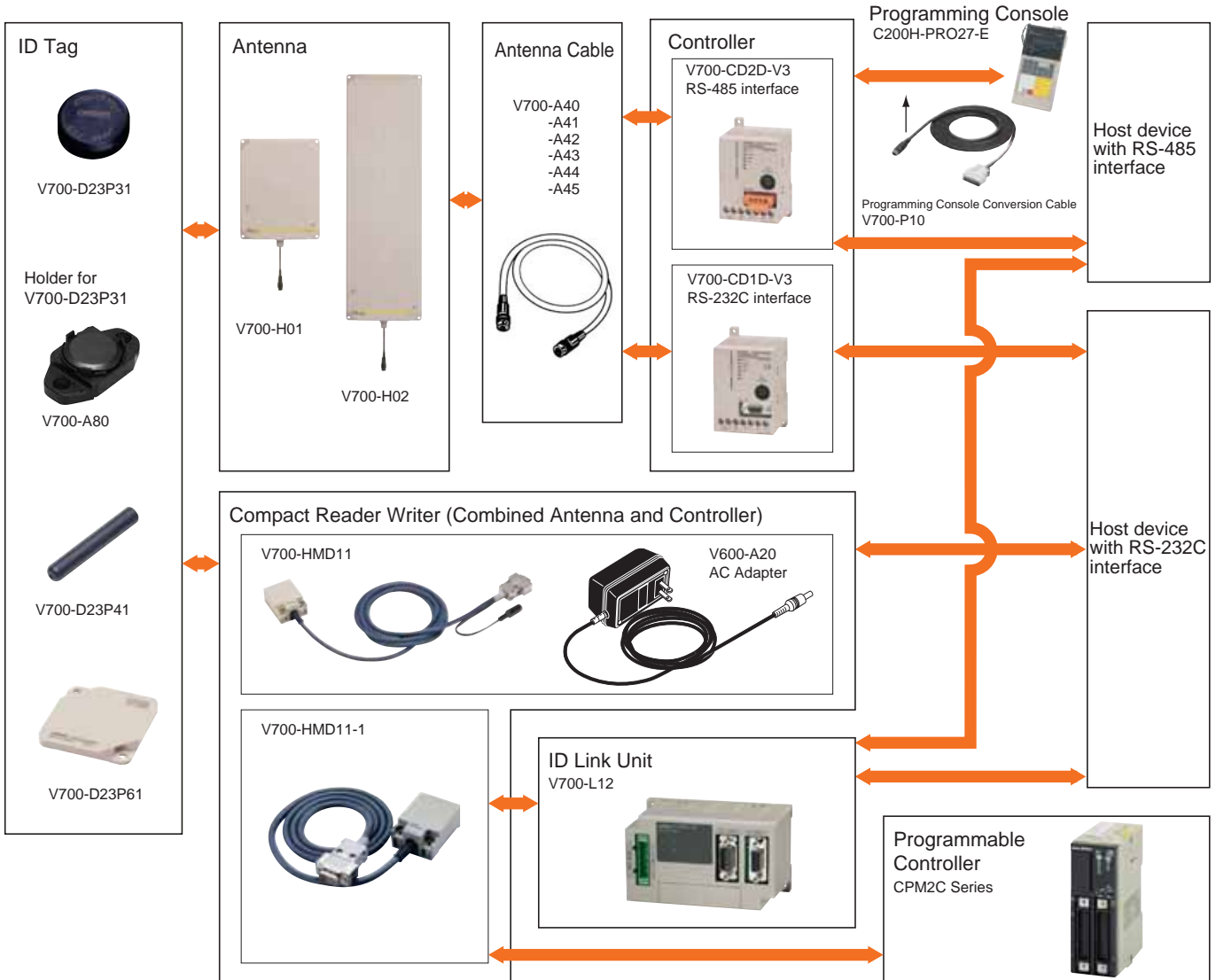

**Note:** The V700-CD1D-V3, V700-HMD11(-1), and V700-L12 all have different function and command structures.

# Functions

## Transmission Functions

	V700-CD1D-V3 V700-CD2D-V3	V700-HMD11 V700-HMD11-1
Single access	Provided	Provided
FIFO	Provided	Provided
Multiple access	Provided	Not provided
Selective access	Provided	Not provided

**Note:** The V700-CD□D-V□ and V700-HMD11(-1) have different command structures.

## Transmission Time (Reference)

The transmission time is the time required for transmission between the Antenna and ID Tag and does not include time required for host communications.

### V700-CD□D-V□

Asynchronous	Write	$T = 52.8 N + 113.5$
	Read	$T = 46.7 N + 60.7$
Read-only synchronization	Read	$T = 46.7 N + 107.4$
Read-write synchronization	Write	$T = 52.8 N + 172.4$
	Read	$T = 52.8 N + 119.6$

### V700-HMD11/HMD11-1

Read	$T = 48 N + 66$
Write	$T = 55 N + 120$

**Note:** T = Transmission time (ms)  
N = Number of pages (1 page = 8 bytes)

### Precautions on Using the Product near Noise Sources

This product makes transmissions to ID Tags using a frequency of 125 kHz. Transceivers, motors, monitoring devices, and power supplies have parts that generate electromagnetic waves (noise). These waves may interfere with transmissions to ID Tags. Before using this product near these kinds of devices, check that there is no adverse affect on transmissions.

### Multiple Access with the V700-CD□D-V□

The transmission time when using multiple-access commands not only depends on the number of bytes, but also on the number of ID Tags in the transmission range and the combination of the ID Tags' codes. The average values for random ID codes are given below. (units: ms)

Number of Tags	Reading 8 bytes	Writing 8 bytes
5	579	873
10	1,191	1,547
15	1,857	2,275
20	2,523	3,002
30	3,853	4,455
50	6,344	7,192

## Mutual Interference Prevention Functions (Using the V700-CD□D-V□)

If there is less than 15 m between Antennas, all the Antennas must be synchronized to prevent mutual interference. This can be done using either of the two methods described below.

### Read-only Synchronization

If all the Antennas only use read commands, this method can be used to reduce the access time.

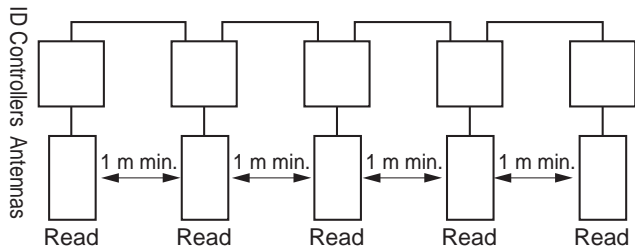

### Read/Write Synchronization

This is the synchronization method that is usually used. It enables the synchronization of both read and write commands for several connected Antennas.

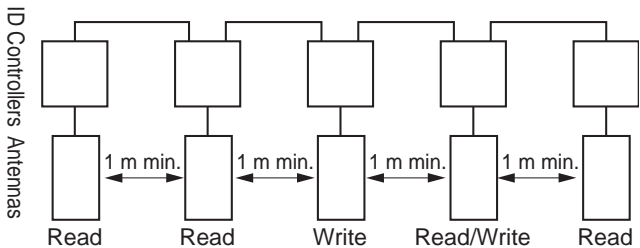

# Characteristic Data (Typical)

## Transmission Range

### Antenna Operation Range Graphs

V700-H01 & V700-D23P31

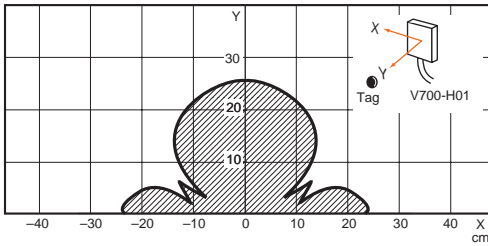

V700-H02 & V700-D23P31

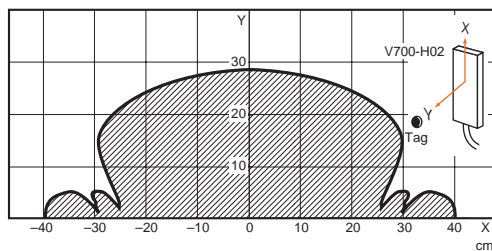
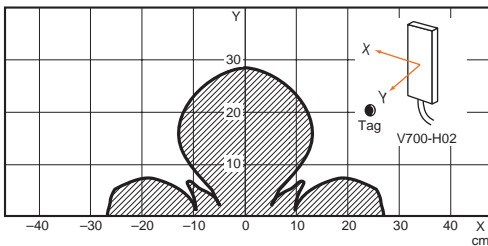

V700-HMD11(-1) & V700-D23P31

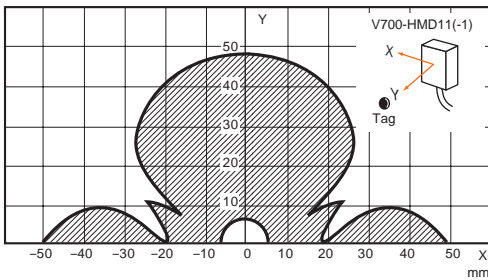

V700-H01 & V700-D23P41

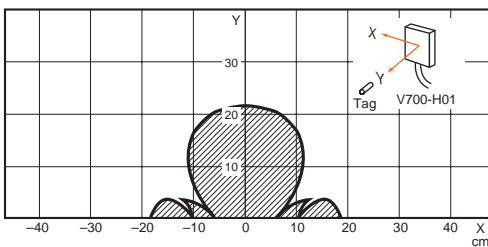

V700-H02 & V700-D23P41

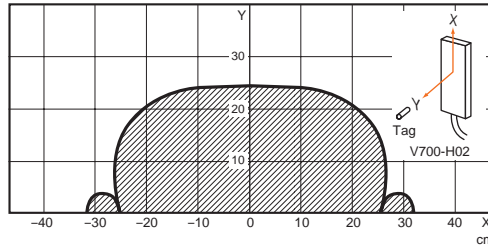
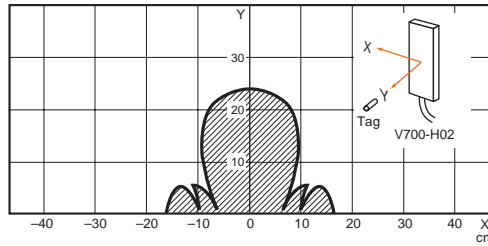

V700-HMD11(-1) & V700-D23P41

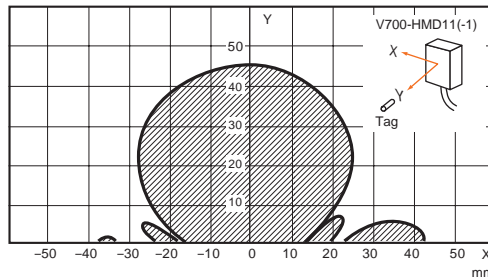

V700-H02 & V700-D23P61

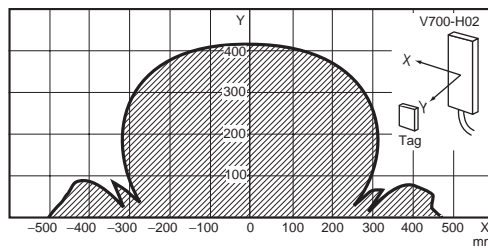

V700-HMD11 & V700-D23P61

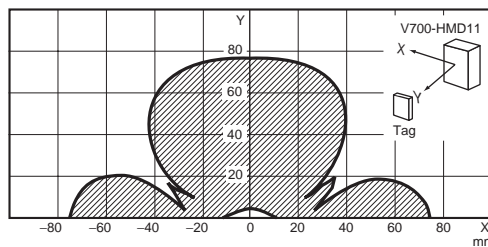

V700-CH1D & V700-D23P61

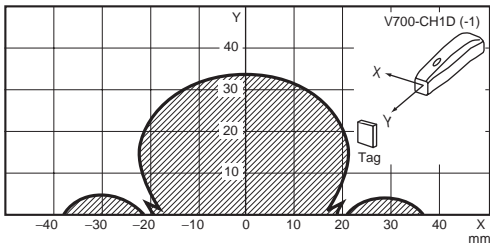

## Dimensions

**Note:** All units are in millimeters unless otherwise indicated.

### ID Tag

V700-D23P31  
Coin-shaped ID Tag

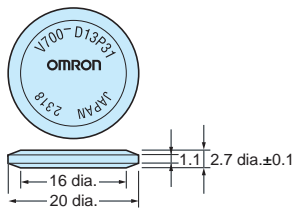

V700-D23P41  
Stick-shaped ID Tag

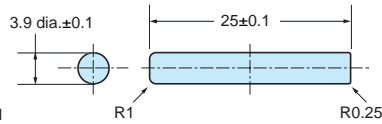

### ID Tag Holder (for V700-D23P31)

V700-A80

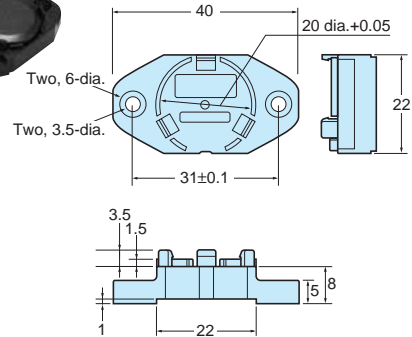

V700-D23P61  
Square Tags

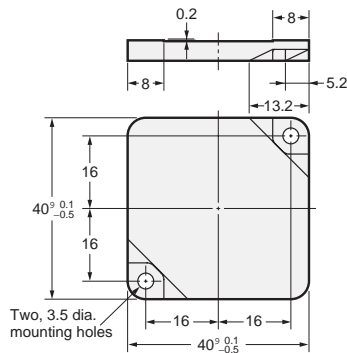

### Mounting Hole Dimensions

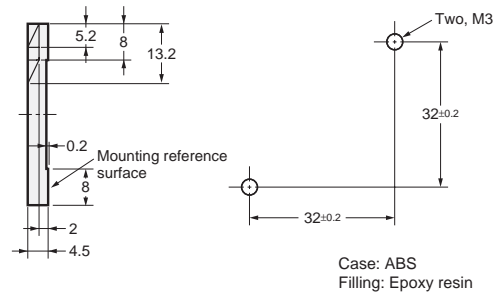

### Antenna

V700-H01 Standard Antenna

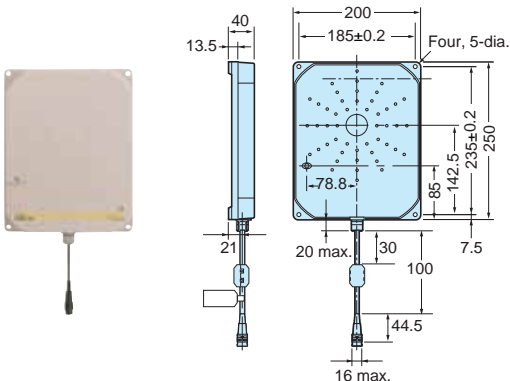

V700-H02 Wide-field Antenna

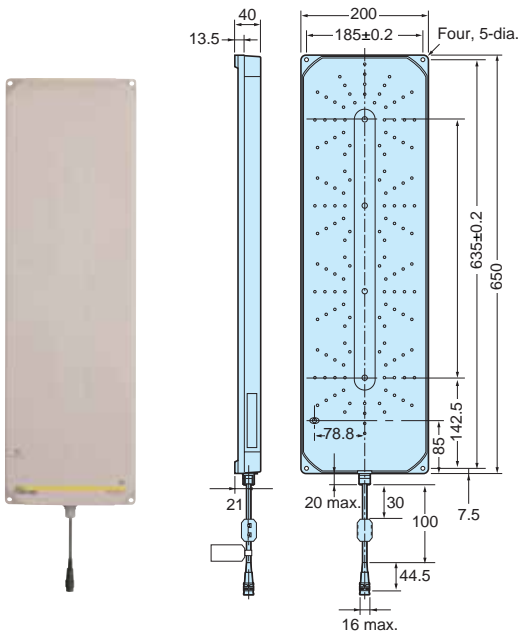

Compact Reader Writer

V700-HMD11

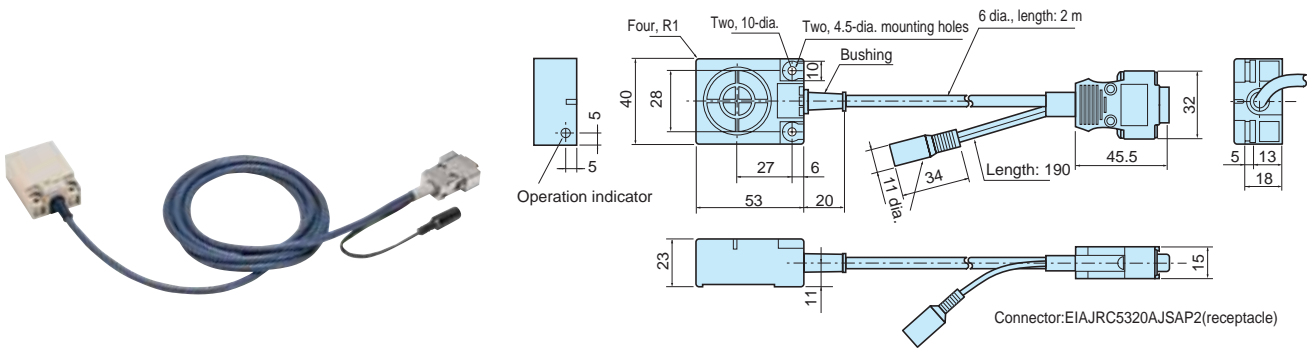

V700-HMD11-1

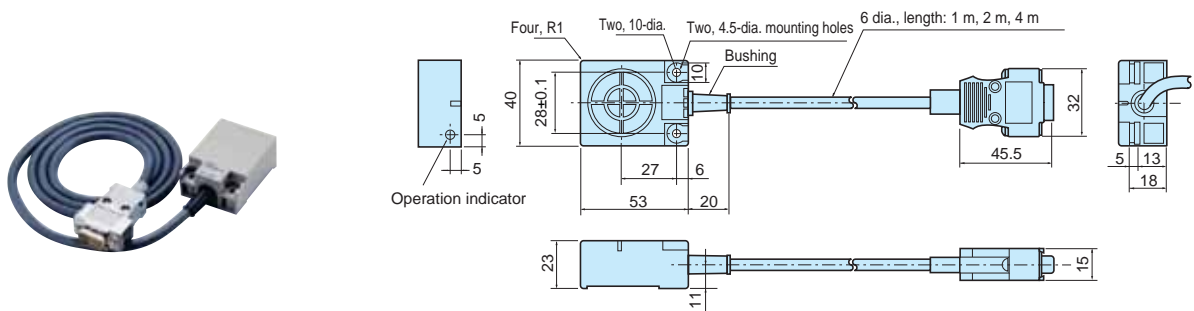



**Controller**

**V700-CD1D-V3**

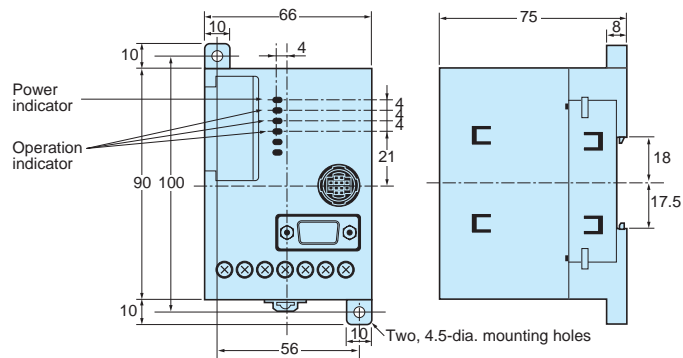

**V700-CD2D-V3**

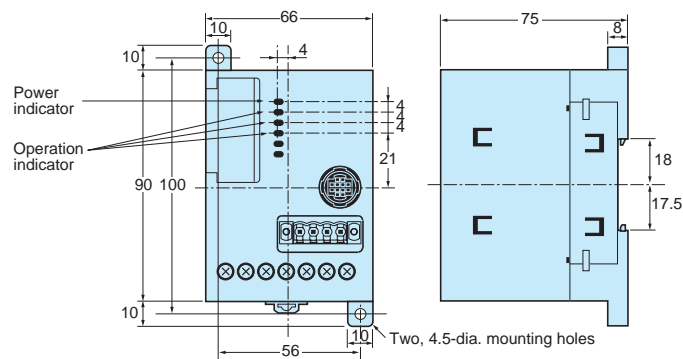

**ID Link Unit**

**V700-L12**

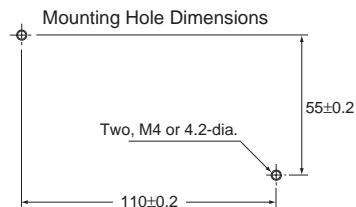
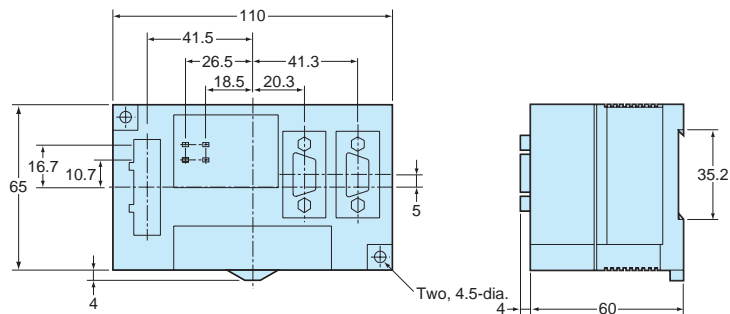

AC Adapter

V600-A20

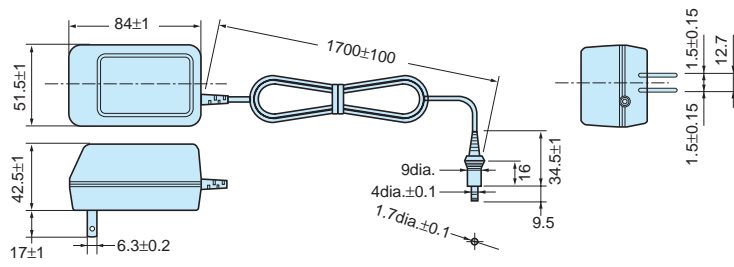
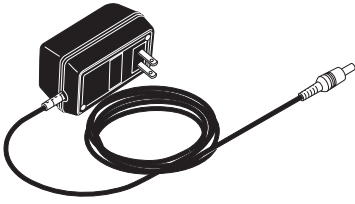

ALL DIMENSIONS SHOWN ARE IN MILLIMETERS.  
 To convert millimeters into inches, multiply by 0.03937. To convert grams into ounces, multiply by 0.03527.

## **READ AND UNDERSTAND THIS DOCUMENT**

Please read and understand this document before using the products. Please consult your OMRON representative if you have any questions or comments.

## **WARRANTY**

OMRON's exclusive warranty is that the products are free from defects in materials and workmanship for a period of one year (or other period if specified) from date of sale by OMRON.

OMRON MAKES NO WARRANTY OR REPRESENTATION, EXPRESS OR IMPLIED, REGARDING NON-INFRINGEMENT, MERCHANTABILITY, OR FITNESS FOR PARTICULAR PURPOSE OF THE PRODUCTS. ANY BUYER OR USER ACKNOWLEDGES THAT THE BUYER OR USER ALONE HAS DETERMINED THAT THE PRODUCTS WILL SUITABLY MEET THE REQUIREMENTS OF THEIR INTENDED USE. OMRON DISCLAIMS ALL OTHER WARRANTIES, EXPRESS OR IMPLIED.

## **LIMITATIONS OF LIABILITY**

OMRON SHALL NOT BE RESPONSIBLE FOR SPECIAL, INDIRECT, OR CONSEQUENTIAL DAMAGES, LOSS OF PROFITS OR COMMERCIAL LOSS IN ANY WAY CONNECTED WITH THE PRODUCTS, WHETHER SUCH CLAIM IS BASED ON CONTRACT, WARRANTY, NEGLIGENCE, OR STRICT LIABILITY.

In no event shall responsibility of OMRON for any act exceed the individual price of the product on which liability is asserted.

IN NO EVENT SHALL OMRON BE RESPONSIBLE FOR WARRANTY, REPAIR, OR OTHER CLAIMS REGARDING THE PRODUCTS UNLESS OMRON'S ANALYSIS CONFIRMS THAT THE PRODUCTS WERE PROPERLY HANDLED, STORED, INSTALLED, AND MAINTAINED AND NOT SUBJECT TO CONTAMINATION, ABUSE, MISUSE, OR INAPPROPRIATE MODIFICATION OR REPAIR.

## **SUITABILITY FOR USE**

THE PRODUCTS CONTAINED IN THIS DOCUMENT ARE NOT SAFETY RATED. THEY ARE NOT DESIGNED OR RATED FOR ENSURING SAFETY OF PERSONS, AND SHOULD NOT BE RELIED UPON AS A SAFETY COMPONENT OR PROTECTIVE DEVICE FOR SUCH PURPOSES. Please refer to separate catalogs for OMRON's safety rated products.

OMRON shall not be responsible for conformity with any standards, codes, or regulations that apply to the combination of products in the customer's application or use of the product.

At the customer's request, OMRON will provide applicable third party certification documents identifying ratings and limitations of use that apply to the products. This information by itself is not sufficient for a complete determination of the suitability of the products in combination with the end product, machine, system, or other application or use.

The following are some examples of applications for which particular attention must be given. This is not intended to be an exhaustive list of all possible uses of the products, nor is it intended to imply that the uses listed may be suitable for the products:

- Outdoor use, uses involving potential chemical contamination or electrical interference, or conditions or uses not described in this document.
- Nuclear energy control systems, combustion systems, railroad systems, aviation systems, medical equipment, amusement machines, vehicles, safety equipment, and installations subject to separate industry or government regulations.
- Systems, machines, and equipment that could present a risk to life or property.

Please know and observe all prohibitions of use applicable to the products.

NEVER USE THE PRODUCTS FOR AN APPLICATION INVOLVING SERIOUS RISK TO LIFE OR PROPERTY WITHOUT ENSURING THAT THE SYSTEM AS A WHOLE HAS BEEN DESIGNED TO ADDRESS THE RISKS, AND THAT THE OMRON PRODUCT IS PROPERLY RATED AND INSTALLED FOR THE INTENDED USE WITHIN THE OVERALL EQUIPMENT OR SYSTEM.

## **PERFORMANCE DATA**

Performance data given in this document is provided as a guide for the user in determining suitability and does not constitute a warranty. It may represent the result of OMRON's test conditions, and the users must correlate it to actual application requirements. Actual performance is subject to the OMRON Warranty and Limitations of Liability.

## **CHANGE IN SPECIFICATIONS**

Product specifications and accessories may be changed at any time based on improvements and other reasons.

It is our practice to change model numbers when published ratings or features are changed, or when significant construction changes are made. However, some specifications of the product may be changed without any notice. When in doubt, special model numbers may be assigned to fix or establish key specifications for your application on your request. Please consult with your OMRON representative at any time to confirm actual specifications of purchased products.

## **DIMENSIONS AND WEIGHTS**

Dimensions and weights are nominal and are not to be used for manufacturing purposes, even when tolerances are shown.

## **ERRORS AND OMISSIONS**

The information in this document has been carefully checked and is believed to be accurate; however, no responsibility is assumed for clerical, typographical, or proofreading errors, or omissions.

## **PROGRAMMABLE PRODUCTS**

OMRON shall not be responsible for the user's programming of a programmable product, or any consequence thereof.

## **COPYRIGHT AND COPY PERMISSION**

This document shall not be copied for sales or promotions without permission.

This document is protected by copyright and is intended solely for use in conjunction with the product. Please notify us before copying or reproducing this document in any manner, for any other purpose. If copying or transmitting this document to another, please copy or transmit it in its entirety.

Cat. No. Q111-E1-04

In the interest of product improvement, specifications are subject to change without notice.

---

## **OMRON Corporation**

Industrial Automation Company

Application Sensors Division  
Sensing Devices and Components Division H.Q.  
Shiohara Horikawa, Shimogyo-ku,  
Kyoto, 600-8530 Japan  
Tel: (81)75-344-7068/Fax: (81)75-344-7107

Printed in Japan  
1004