

Relays with Forcibly Guided Contacts G7SB

Low Profile Relays with Low Power Consumption

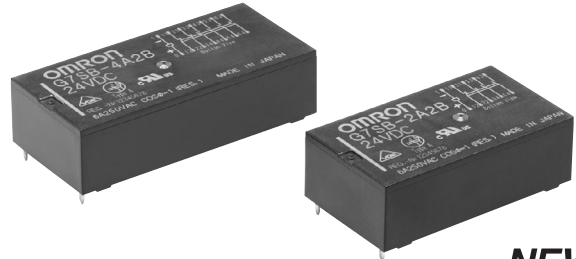

- Relays with forcibly guided contacts (EN50205 Class A, certified by VDE).
- Low profile - only 14.5 mm.
- Coil power consumption is 360 mW for 4 pole model or 500 mW for 6 pole model.
- Four-pole and six-pole Relays are available.
- The Relay's terminal arrangement simplifies PWB pattern design.
- Reinforced insulation



NEW

Model Number Structure

Model Number Legend

G7SB- A B
1 2

- 1. NO Contact Poles**
 2: DPST-NO
 3: 3PST-NO
 4: 4PST-NO
 5: 5PST-NO

- 2. NC Contact Poles**
 1: SPST-NC
 2: DPST-NC

Ordering Information

Relays with Forcibly Guided Contacts

Type	Sealing	Poles	Contact configuration	Rated voltage *	Model
Standard	Flux-tight	4 poles	3PST-NO, SPST-NC	24 VDC	G7SB-3A1B
			DPST-NO, DPST-NC		G7SB-2A2B
		6 poles	5PST-NO, SPST-NC		G7SB-5A1B
			4PST-NO, DPST-NC		G7SB-4A2B

Consult your OMRON representative for details on rated voltages of 12 VDC, 18 VDC and 21 VDC.

G7SB

Specifications

Ratings

Coil

Rated voltage	Item	Rated current (mA)	Coil resistance (Ω)	Must operate voltage (V)	Must release voltage (V)	Max. voltage (V)	Power consumption (mW)
24 VDC		4 poles: 15 6 poles: 20.8	4 poles: 1,600 6 poles: 1,152	75% max.	10% min.	110%	4 poles: Approx. 360 6 poles: Approx. 500

- Note:** 1. The rated current and coil resistance are measured at a coil temperature of 23°C with tolerances of $\pm 15\%$.
2. Performance characteristics are based on a coil temperature of 23°C.
3. The value given for the maximum voltage is for voltages applied Instantaneously to the Relay coil (at an ambient temperature of 23°C) and not continuously.

Contacts

Item	Load	Resistive load
Rated load		6 A at 250 VAC, 6 A at 30 VDC
Rated carry current		6 A
Max. switching voltage		250 VAC, 125 VDC
Max. switching current		6 A

Characteristics

Contact resistance *1		100 m Ω max.
Operating time *2		20 ms max.
Response time *3		10 ms max.
Release time *2		20 ms max.
Maximum operating frequency	Mechanical	36,000 operations/h
	Rated load	1,800 operations/h
Insulation resistance *4		1,000 M Ω min. (at 500 VDC)
Dielectric strength *5		Between coil contacts/different poles: 3,000 VAC, 50/60 Hz for 1 min. Between poles 1–2, 2–3, and 3–4: 3,000 VAC, 50/60 Hz for 1 min. Between poles 4–5 and 5–6 (in 6-pole relays): 2,500 VAC, 50/60 Hz for 1 min. Between contacts of same polarity: 1,500 VAC, 50/60 Hz for 1 min.
Vibration resistance		10 to 55 Hz, 0.75-mm single amplitude (1.5-mm double amplitude)
Shock resistance	Destruction	1,000 m/s ²
	Malfunction	100 m/s ²
Durability *6	Mechanical	10,000,000 operations min. (at approx. 36,000 operations/h)
	Electrical	100,000 operations min. (at the rated load and approx. 1,800 operations/h)
Failure rate (P level) (reference value *7)		5 VDC, 1 mA
Ambient operating temperature *8		–40 to 85°C (with no icing or condensation)
Ambient operating humidity		5% to 85%
Weight		4 poles: Approx. 25 g 6 poles: Approx. 29 g

Note: The above values are initial values.

*1. The contact resistance was measured with 1 A at 5 VDC using the voltage-drop method.

*2. These times were measured at the rated voltage and an ambient temperature of 23°C. Contact bounce time is not included.

*3. The response time is the time it takes for the normally open contacts to open after the coil voltage is turned OFF. Contact bounce time is included. Measurement conditions: Rated voltage operation, Ambient temperature: 23°C

*4. The insulation resistance was measured with a 500-VDC megohmmeter at the same locations as the dielectric strength was measured.

*5. Pole 3 refers to terminals 33–34, pole 4 refers to terminals 43–44, pole 5 refers to terminals 53–54, and pole 6 refers to terminals 63–64.

*6. The durability is for an ambient temperature of 15 to 35°C and an ambient humidity of 25% to 75%.

*7. The failure rate is based on an operating frequency of 300 operations/min.

*8. When operating at a temperature between 70 and 85°C, reduce the rated carry current (6 A at 70°C or less) by 0.1 A for each degree above 70°C.

Dimensions

Relays with Forcibly Guided Contacts

G7SB-3A1B
G7SB-2A2B

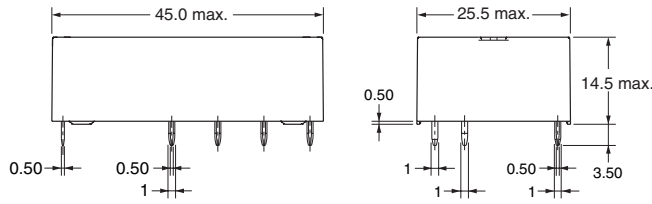

Printed Circuit Board Design Diagram (Bottom View)
(±0.1 tolerance)

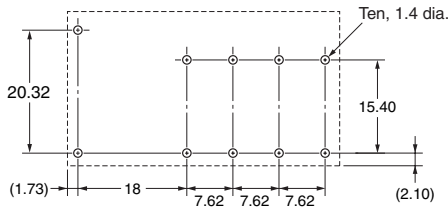

Terminal Arrangement/ Internal Connection Diagram (Bottom View)

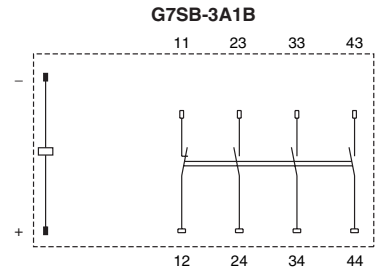

G7SB-2A2B

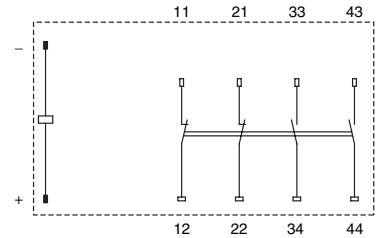

Note: Terminals 23-24, 33-34, and 43-44 are normally open. Terminals 11-12 and 21-22 are normally closed.

G7SB-5A1B
G7SB-4A2B

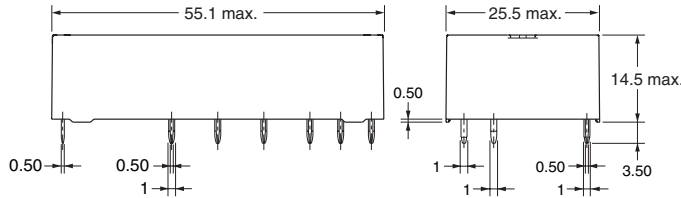
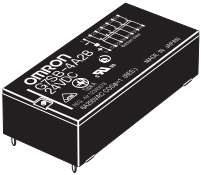

Printed Circuit Board Design Diagram (Bottom View)
(±0.1 tolerance)

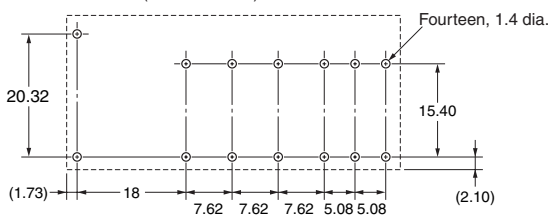

Terminal Arrangement/ Internal Connection Diagram (Bottom View)

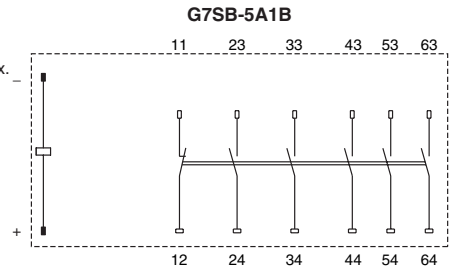

G7SA-4A2B

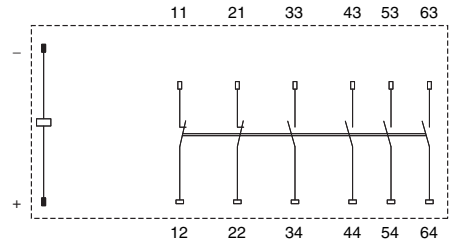

Note: Terminals 23-24, 33-34, 43-44, 53-54, and 63-64 are normally open. Terminals 11-12 and 21-22 are normally closed.

Certified Standards

G7SB

- EN Standards, VDE Certified
EN61810-1 (Electromechanical non-specified time all-or-nothing relays)
EN50205 (Relays with forcibly guided (linked) contacts)
- UL standard UL508 Industrial Control Devices
- CSA standard CSA C22.2 No. 14 Industrial Control Devices

Forcibly Guided Contacts (from EN50205)

If an NO contact becomes welded, all NC contacts will maintain a minimum distance of 0.5 mm when the coil is not energized. Likewise if an NC contact becomes welded, all NO contacts will maintain a minimum distance of 0.5 mm when the coil is energized.

Safety Precautions

Refer to the **“Precautions for All Relays”** and **“Precautions for All Relays with Forcibly Guided Contacts”** of Safety Series Catalog (Cat. No. Y106).

Precautions for Safe Use

Connections

The coil terminals have polarity (+/-). Operation will not be possible if the polarity is reversed.

Washing

The G7SB does not have a sealed structure. Do not wash G7SB Relays.

Precautions for Correct Use

Mounting

The Relays with Forcibly Guided Contacts can be mounted in any direction.

Relays with Forcibly Guided Contacts

While the Relay with Forcibly Guided Contacts has the previously described forcibly guided contact structure, it is basically the same as an ordinary relay in other respects. Rather than serving to prevent malfunctions, the forcibly guided contact structure enables another circuit to detect the condition following a contact weld or other malfunction. Accordingly, when a contact weld occurs in a Relay with Forcibly Guided Contacts, depending on the circuit configuration, the power may not be interrupted, leaving the Relay in a potentially dangerous condition (as shown in Fig. 1.)

To configure the power control circuit to interrupt the power when a contact weld or other malfunction occurs, and to prevent restarting until the problem has been eliminated, add another Relay with Forcibly Guided Contacts or similar Relay in combination to provide redundancy and a self-monitoring function to the circuit (as shown in Fig. 2.) Refer to the *Safety Components Technical Guide*.

The G9S/G9SA/G9SB Safety Relay Unit, which combines Relays such as the Relay with Forcibly Guided Contacts in order to provide the above-described functions, is available for this purpose. By connecting a contactor with appropriate input and output to the Safety Relay Unit, the circuit can be equipped with redundancy and a self-monitoring function.

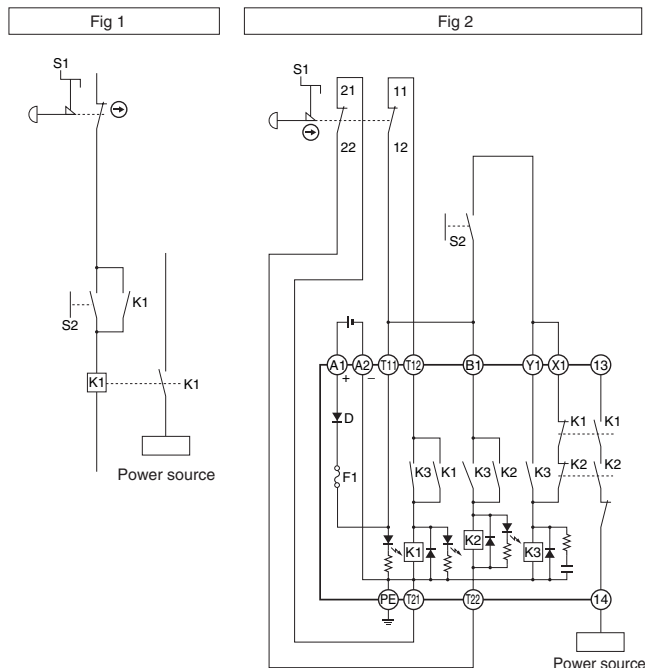

Durability of Contact Outputs

The durability of the Relays with Forcibly Guided Contacts varies considerably depending on switching conditions. Always confirm the usage conditions by testing the Relay with Forcibly Guided Contacts in an actual application, and use the Relay with Forcibly Guided Contacts only for the number of switching operations that its performance allows.

Restarting a safety circuit like the one incorporating the Relay with Forcibly Guided Contacts in Fig. 2 may not be possible if the switching capacity is exceeded. If this occurs, replace the relevant relays immediately. If a Relay with Forcibly Guided Contacts is used after performance has deteriorated, it may result in reduced safety.

CE Marking

(Source: *Guidelines on the Application of Council Directive 73/23/EEC*)

The G7SB has been recognized by the VDE for meeting the Low Voltage Directive according to EN requirements for relays and relays with forcibly guided contacts. The Low Voltage Directive, however, contains no clauses that specify handling methods for components, and interpretations vary among test sites and manufacturers. To solve this problem, the European Commission has created guidelines for the application of the Low Voltage Directive in EU. These guidelines present concepts for applying the Low Voltage Directive to components.

The G7SB, however, does not display the CE Marking according to the concepts in the guidelines.

VDE recognition, however, has been obtained, so there should be no problems in obtaining the CE Marking for machines that use the G7SB.

Use the manufacturer's compliance declaration to prove standard conformance.

Contents of the Guidelines

The *Guidelines on the Application of Council Directive 73/23/EEC* apply to components. Relays with PWB terminals are not covered by the Low Voltage Directive.

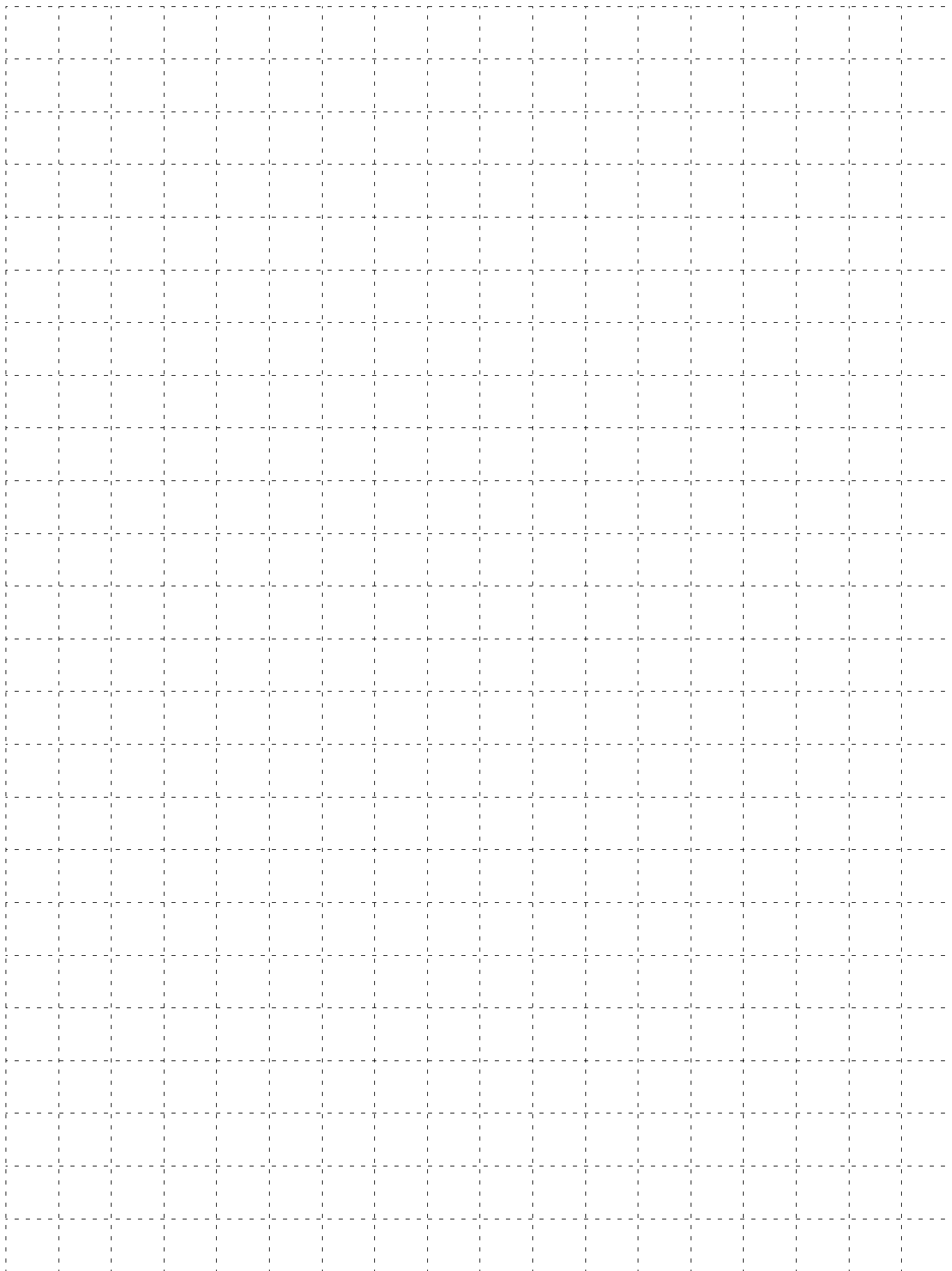

G7SB

MEMO

A large grid of dashed lines for writing a memo. The grid consists of 15 columns and 25 rows of squares, providing a structured space for notes or calculations.

Warranty and Application Considerations

Warranty and Limitations of Liability

WARRANTY

OMRON's exclusive warranty is that the products are free from defects in materials and workmanship for a period of one year (or other period if specified) from date of sale by OMRON.

OMRON MAKES NO WARRANTY OR REPRESENTATION, EXPRESS OR IMPLIED, REGARDING NON-INFRINGEMENT, MERCHANTABILITY, OR FITNESS FOR PARTICULAR PURPOSE OF THE PRODUCTS. ANY BUYER OR USER ACKNOWLEDGES THAT THE BUYER OR USER ALONE HAS DETERMINED THAT THE PRODUCTS WILL SUITABLY MEET THE REQUIREMENTS OF THEIR INTENDED USE. OMRON DISCLAIMS ALL OTHER WARRANTIES, EXPRESS OR IMPLIED.

LIMITATIONS OF LIABILITY

OMRON SHALL NOT BE RESPONSIBLE FOR SPECIAL, INDIRECT, OR CONSEQUENTIAL DAMAGES, LOSS OF PROFITS, OR COMMERCIAL LOSS IN ANY WAY CONNECTED WITH THE PRODUCTS, WHETHER SUCH CLAIM IS BASED ON CONTRACT, WARRANTY, NEGLIGENCE, OR STRICT LIABILITY.

In no event shall the responsibility of OMRON for any act exceed the individual price of the product on which liability is asserted.

IN NO EVENT SHALL OMRON BE RESPONSIBLE FOR WARRANTY, REPAIR, OR OTHER CLAIMS REGARDING THE PRODUCTS UNLESS OMRON'S ANALYSIS CONFIRMS THAT THE PRODUCTS WERE PROPERLY HANDLED, STORED, INSTALLED, AND MAINTAINED AND NOT SUBJECT TO CONTAMINATION, ABUSE, MISUSE, OR INAPPROPRIATE MODIFICATION OR REPAIR.

Application Considerations

SUITABILITY FOR USE

OMRON shall not be responsible for conformity with any standards, codes, or regulations that apply to the combination of products in the customer's application or use of the products.

Take all necessary steps to determine the suitability of the product for the systems, machines, and equipment with which it will be used.

Know and observe all prohibitions of use applicable to this product.

NEVER USE THE PRODUCTS FOR AN APPLICATION INVOLVING SERIOUS RISK TO LIFE OR PROPERTY WITHOUT ENSURING THAT THE SYSTEM AS A WHOLE HAS BEEN DESIGNED TO ADDRESS THE RISKS, AND THAT THE OMRON PRODUCTS ARE PROPERLY RATED AND INSTALLED FOR THE INTENDED USE WITHIN THE OVERALL EQUIPMENT OR SYSTEM.

Disclaimers

CHANGE IN SPECIFICATIONS

Product specifications and accessories may be changed at any time based on improvements and other reasons. Consult with your OMRON representative at any time to confirm actual specifications of purchased product.

DIMENSIONS AND WEIGHTS

Dimensions and weights are nominal and are not to be used for manufacturing purposes, even when tolerances are shown.

ALL DIMENSIONS SHOWN ARE IN MILLIMETERS.

To convert millimeters into inches, multiply by 0.03937. To convert grams into ounces, multiply by 0.03527.

Cat. No. J165-E1-01 **In the interest of product improvement, specifications are subject to change without notice.**

OMRON Corporation

Industrial Automation Company

Safety Devices Division

Shiokoji Horikawa, Shimogyo-ku,

Kyoto, 600-8530 Japan

Tel: (81)75-344-7093/Fax: (81)75-344-8197

Printed in Japan

0907-0.3M (0907) (B)