

General-purpose Relay MY New model

Versatile and Function-filled Miniature Power Relay for Sequence Control and Power Switching Applications

- Models with lockable test buttons now available.
- Many variations possible through a selection of operation indicators (mechanical and LED indicators), lockable test button, built-in diode and CR (surge suppression), bifurcated contacts, etc.
- Arc barrier standard on 4-pole Relays.
- Dielectric strength: 2,000 VAC (coil to contact)
- Environment-friendly cadmium-free contacts.
- Safety standard approvals obtained.
- Wide range of Sockets (PY, PYF Series) and optional parts are available.
- Max. Switching Current: 2-pole: 10 A, 4-pole: 5 A
- Provided with nameplate.



Ordering Information

■ Relays

Standard Coil Polarity

Type	Contact form	Plug-in socket/Solder terminals		Without LED indicator
		Standard with LED indicator	With LED indicator and lockable test button	
Standard	DPDT	MY2N	MY2IN	MY2
	4PDT	MY4N	MY4IN	MY4
	4PDT (bifurcated)	MY4ZN	MY4ZIN	MY4Z
With built-in diode (DC only)	DPDT	MY2N-D2	MY2IN-D2	---
	4PDT	MY4N-D2	MY4IN-D2	---
	4PDT (bifurcated)	MY4ZN-D2	MY4ZIN-D2	---
With built-in CR (220/240 VAC, 110/120 VAC only)	DPDT	MY2N-CR	MY2IN-CR	---
	4PDT	MY4N-CR	MY4IN-CR	---
	4PDT (bifurcated)	MY4ZN-CR	MY4ZIN-CR	---

Reverse Coil Polarity

Type	Contact form	Plug-in socket/Solder terminals	
		With LED indicator	With LED indicator and lockable test button
Standard (DC only)	DPDT	MY2N1	MY2IN1
	4PDT	MY4N1	MY4IN1
	4PDT (bifurcated)	MY4ZN1	MY4ZIN1
With built-in diode (DC only)	DPDT	MY2N1-D2	MY2IN1-D2
	4PDT	MY4N1-D2	MY4IN1-D2
	4PDT (bifurcated)	MY4ZN1-D2	MY4ZIN1-D2

Note: When ordering, add the rated coil voltage and “(s)” to the model number. Rated coil voltages are given in the coil ratings table.

Example: MY2 6VAC (S)
 ↑ └── New model
 Rated coil voltage

■ Accessories (Order Separately)

Sockets

Poles	Front-mounting Socket (DIN-track/screw mounting)	Back-mounting Socket				
		Solder terminals		Wire-wrap terminals		PCB terminals
		Without clip	With clip	Without clip	With clip	
2	PYF08A-E PYF08A-N	PY08	PY08-Y1	PY08QN PY08QN2	PY08QN-Y1 PY08QN2-Y1	PY08-02
4	PYF14A-E PYF14A-N	PY14	PY14-Y1	PY14QN PY14QN2	PY14QN-Y1 PY14QN2-Y1	PY14-02

Socket Hold-down Clip Pairing

Relay type	Poles	Front-connecting Socket (DIN-track/screw mounting)		Back-connecting Socket			
				Solder/Wire-wrap terminals		PCB terminals	
		Socket	Clip	Socket	Clip	Socket	Clip
Without 2-pole test button	2	PYF08A-E PYF08A-N	PYC-A1	PY08(QN)	PYC-P PYC-P2	PY08-02	PYC-P PYC-P2
	4	PYF14A-E PYF14A-N		PY14(QN)		PY14-02	
2-pole test button	2	PYF08A-E PYF08A-N	PYC-E1	PY08(QN)	PYC-P2	PY08-02	PYC-P2

Mounting Plates for Sockets

Socket model	For 1 Socket	For 18 Sockets	For 36 Sockets
PY08, PY08QN(2), PY14, PY14QN(2)	PYP-1	PYP-18	PYP-36

Note: PYP-18 and PYP-36 can be cut into any desired length in accordance with the number of Sockets.

Track and Accessories

Supporting Track (length = 500 mm)	PFP-50N
Supporting Track (length = 1,000 mm)	PFP-100N, PFP-100N2
End Plate	PFP-M
Spacer	PFP-S

Specifications

■ Coil Ratings

Rated voltage	Rated current		Coil resistance	Coil inductance (reference value)		Must operate voltage	Must release voltage	Max. voltage	Power consumption (approx.)	
	50 Hz	60 Hz		Arm. OFF	Arm. ON					
AC	6 V*	214.1 mA	183 mA	12.2 Ω	0.04 H	0.08 H	80% max.	30% min.	110%	1.0 to 1.2 VA (60 Hz)
	12 V	106.5 mA	91 mA	46 Ω	0.17 H	0.33 H				
	24 V	53.8 mA	46 mA	180 Ω	0.69 H	1.30 H				
	48/50 V*	24.7/ 25.7 mA	21.1/ 22.0 mA	788 Ω	3.22 H	5.66 H				
	110/120 V	9.9/10.8 mA	8.4/9.2 mA	4,430 Ω	19.20 H	32.1 H				
	220/240 V	4.8/5.3 mA	4.2/4.6 mA	18,790 Ω	83.50 H	136.4 H				
DC	6 V*	151 mA		39.8 Ω	0.17 H	0.33 H	10% min.		0.9 W	
	12 V	75 mA		160 Ω	0.73 H	1.37 H				
	24 V	37.7 mA		636 Ω	3.20 H	5.72 H				
	48 V*	18.8 mA		2,560 Ω	10.60 H	21.0 H				
	100/110 V	9.0/9.9 mA		11,100 Ω	45.60 H	86.2 H				

Note: 1. The rated current and coil resistance are measured at a coil temperature of 23°C with tolerances of +15%/–20% for rated currents and ±15% for DC coil resistance.

2. Performance characteristic data are measured at a coil temperature of 23°C.

3. AC coil resistance and impedance are provided as reference values (at 60 Hz).

4. Power consumption drop was measured for the above data. When driving transistors, check leakage current and connect a bleeder resistor if required.

5. Rated voltage denoted by "*" will be manufactured upon request. Ask your OMRON representative.

Contact Ratings

Item	2-pole		4-pole		4-pole (bifurcated)	
	Resistive load ($\cos\phi = 1$)	Inductive load ($\cos\phi = 0.4, L/R = 7\text{ ms}$)	Resistive load ($\cos\phi = 1$)	Inductive load ($\cos\phi = 0.4, L/R = 7\text{ ms}$)	Resistive load ($\cos\phi = 1$)	Inductive load ($\cos\phi = 0.4, L/R = 7\text{ ms}$)
Rated load	5A, 250 VAC 5A, 30 VDC	2A, 250 VAC 2 A, 30 VDC	3 A, 250 VAC 3 A, 30 VDC	0.8 A, 250 VAC 1.5 A, 30 VDC	3 A, 250 VAC 3 A, 30 VDC	0.8 A, 250 VAC 1.5 A, 30 VDC
Carry current	10 A (see note)		5 A (see note)			
Max. switching voltage	250 VAC 125 VDC		250 VAC 125 VDC			
Max. switching current	10 A		5 A			
Max. switching power	2,500 VA 300 W	1,250 VA 300 W	1,250 VA 150 W	500 VA 150 W	1,250 VA 150 W	500 VA 150 W
Failure rate (reference value)	5 VDC, 1 mA		1 VDC, 1 mA		1 VDC, 100 μ A	

Note: Don't exceed the carry current of a Socket in use. Please see page 9.

Characteristics

Item	All Relays
Contact resistance	100 m Ω max.
Operate time	20 ms max.
Release time	20 ms max.
Max. operating frequency	Mechanical: 18,000 operations/hr Electrical: 1,800 operations/hr (under rated load)
Insulation resistance	1,000 M Ω min. (at 500 VDC)
Dielectric strength	2,000 VAC, 50/60 Hz for 1.0 min (1,000 VAC between contacts of same polarity)
Vibration resistance	Destruction: 10 to 55 to 10 Hz, 0.5 mm single amplitude (1.0 mm double amplitude) Malfunction: 10 to 55 to 10 Hz, 0.5 mm single amplitude (1.0 mm double amplitude)
Shock resistance	Destruction: 1,000 m/s ² Malfunction: 200 m/s ²
Endurance	See the following table.
Ambient temperature	Operating: -55°C to 70°C (with no icing)
Ambient humidity	Operating: 5% to 85%
Weight	Approx. 35 g

Note: The values given above are initial values.

Endurance Characteristics

Pole	Mechanical life (at 18,000 operations/hr)	Electrical life (at 1,800 operations/hr under rated load)
2-pole	AC:50,000,000 operations min.	500,000 operations min.
4-pole	DC:100,000,000 operations min.	200,000 operations min.
4-pole (bifurcated)	20,000,000 operations min.	100,000 operations min.

■ Approved Standards

VDE Recognitions (File No. 112467UG, IEC 255, VDE 0435)

No. of poles	Coil ratings	Contact ratings	Operations
2	6, 12, 24, 48/50, 100/110 110/120, 200/220, 220/240 VAC	10 A, 250 VAC (cosφ=1) 10 A, 30 VDC (L/R=0 ms)	10 x 10 ³
4	6, 12, 24, 48, 100/110, 125 VDC	5 A, 250 VAC (cosφ=1) 5 A, 30 VDC (L/R=0 ms)	100 x 10 ³ MY4Z AC; 50 x 10 ³

UL508 Recognitions (File No. 41515)

No. of poles	Coil ratings	Contact ratings	Operations
2	6 to 240 VAC 6 to 125 VDC	10 A, 30 VDC (General purpose) 10 A, 250 VAC (General purpose)	6 x 10 ³
4		5 A, 250 VAC (General purpose) 5 A, 30 VDC (General purpose)	

CSA C22.2 No. 14 Listings (File No. LR31928)

No. of poles	Coil ratings	Contact ratings	Operations
2	6 to 240 VAC 6 to 125 VDC	10 A, 30 VDC 10 A, 250 VAC	6 x 10 ³
4		5 A, 250 VAC (Same polarity) 5 A, 30 VDC (Same polarity)	

IMQ (File No. EN013 to 016)

No. of poles	Coil ratings	Contact ratings	Operations
2	6, 12, 24, 48/50, 100/110 110/120, 200/220, 220/240 VAC	10 A, 30 VDC 10 A, 250 VAC	10 x 10 ³
4		5 A, 250 VAC 5 A, 30 VDC	100 x 10 ³ MY4Z AC; 50 x 10 ³

LR Recognitions (File No. 98/10014)

No. of poles	Coil ratings	Contact ratings	Operations
2	6 to 240 VAC 6 to 125 VDC	10 A, 250 VAC (Resistive) 2 A, 250 VAC (PF0.4) 10 A, 30 VDC (Resistive) 2 A, 30 VDC (L/R=7 ms)	50 x 10 ³
4		5 A, 250 VAC (Resistive) 0.8 A, 250 VAC (PF0.4) 5 A, 30 VDC (Resistive) 1.5 A, 30 VDC (L/R=7 ms)	50 x 10 ³

SEV Listings (File No. 99.5 50902.01)

No. of poles	Coil ratings	Contact ratings	Operations
2	6 to 240 VAC 6 to 125 VDC	10 A, 250 VAC 10 A, 30 VDC	10 x 10 ³
4		5 A, 250 VAC 5 A, 30 VDC	100 x 10 ³ MY4Z AC; 50 x 10 ³

Engineering Data

Maximum Switching Power

MY2

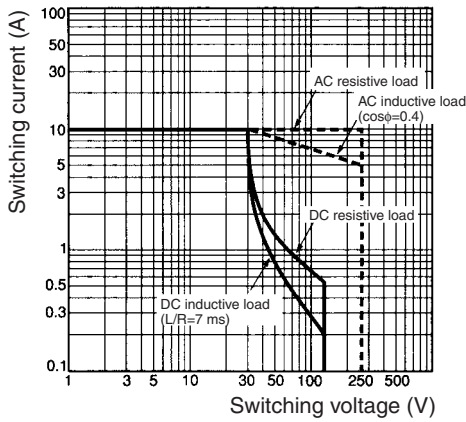

MY4, MY4Z

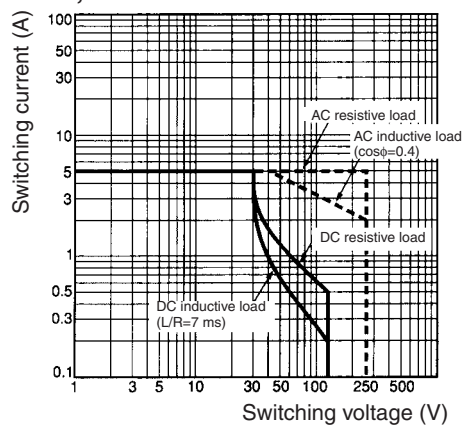

Endurance

MY2 (Resistive Loads)

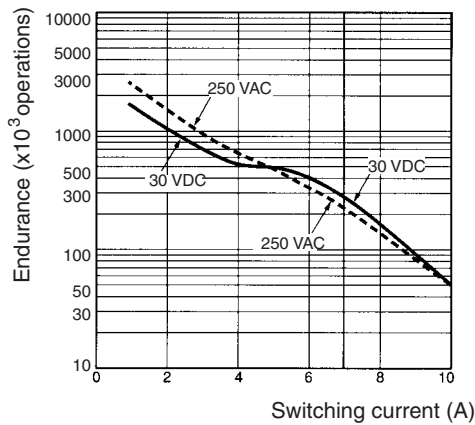

MY2 (Inductive Loads)

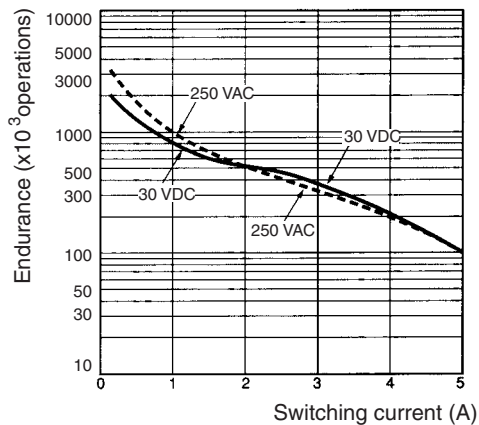

MY4 (Resistive Loads)

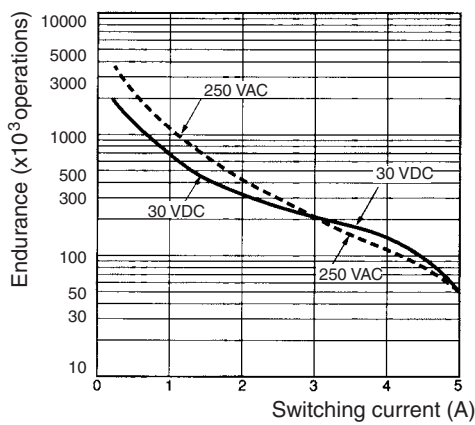

MY4 (Inductive Loads)

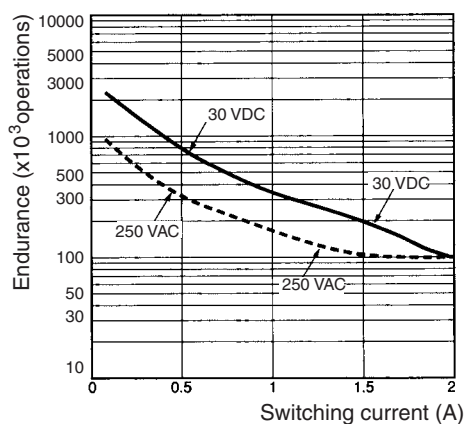

MY4Z (Resistive Loads)

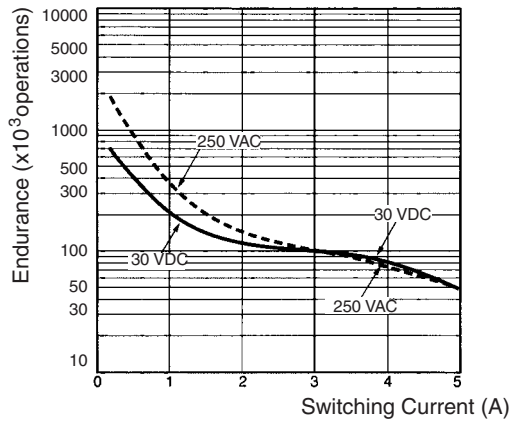

MY4Z (Inductive Loads)

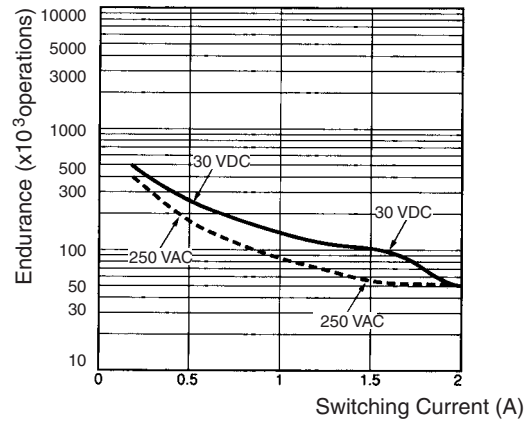

Dimensions

Note: All units are in millimeters unless otherwise indicated.

2-Pole Models

MY2N

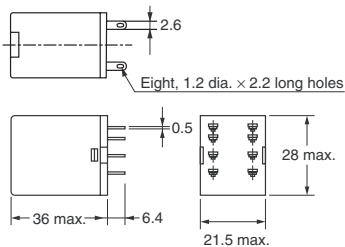
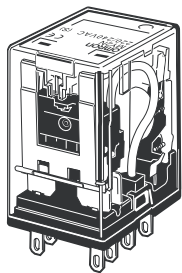

4-Pole Models

MY4N

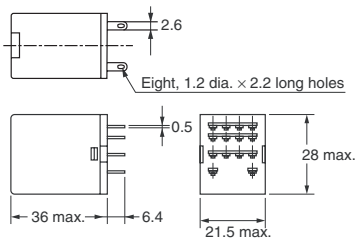
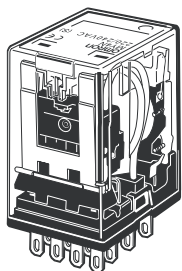

Models with Test Button

MY2IN

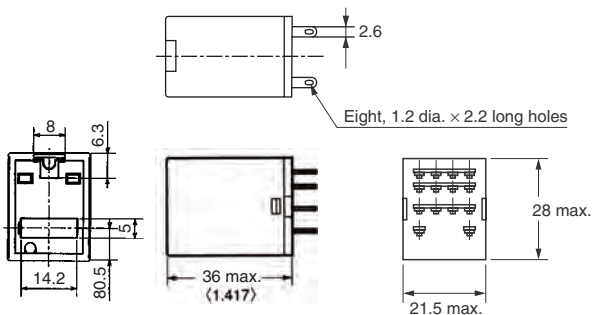
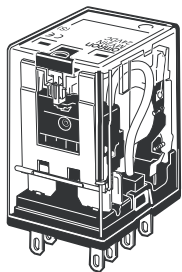

MY4IN

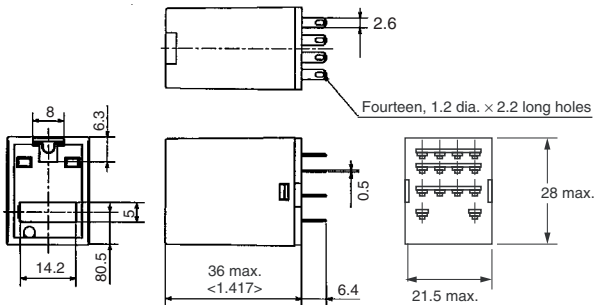
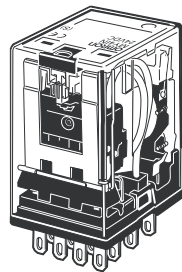

Terminal Arrangement/Internal Connections (Bottom View)

MY2

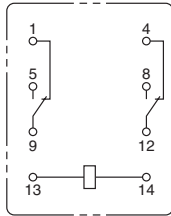

MY2N/MY2IN
(AC Models)

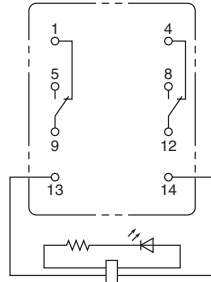

MY2N/MY2IN
(DC Models)

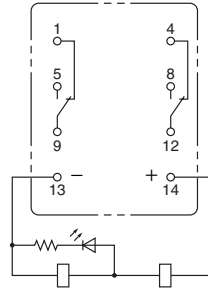

MY2N-D2/MY2IN-D2
(DC Models Only)

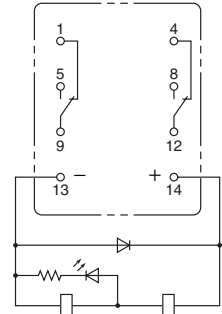

MY2N-CR/MY2IN-CR
(AC Models Only)

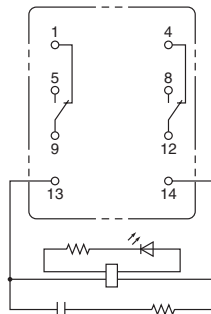

MY2N1/MY2IN1
(DC Models Only)

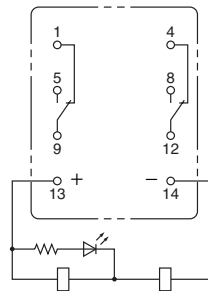

MY2N1-D2/MY2IN1-D2
(DC Models Only)

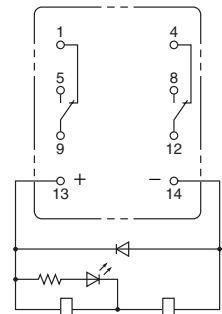

MY4(Z)

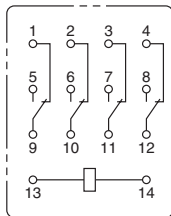

MY4(Z)N/MY4(Z)IN
(AC Models)

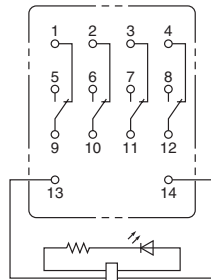

MY4(Z)N/MY4(Z)IN
(DC Models)

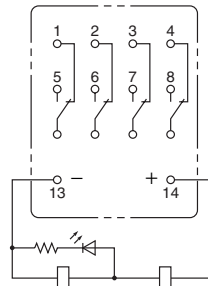

MY4(Z)N-D/MY4(Z)IN-D2
(DC Models Only)

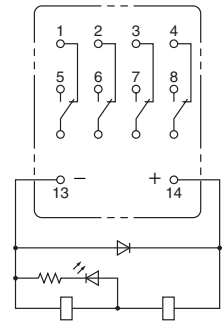

MY4(Z)N-CR/MY4(Z)IN-CR
(AC Models Only)

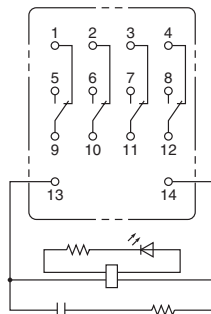

MY4(Z)N1/MY4(Z)IN1
(DC Models Only)

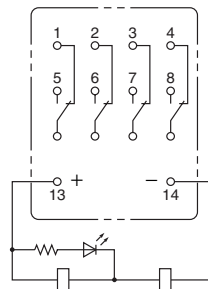

MY4(Z)N1-D2/MY4(Z)IN1-D2
(DC Models Only)

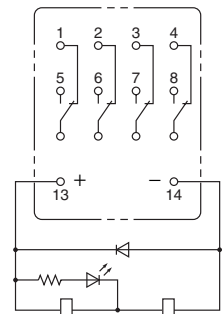

Note: The DC models have polarity.

Socket for MY

Track-mounted (DIN Track) Socket Conforms to VDE 0106, Part 100

- Snap into position along continuous sections of any mounting track.
- Facilitates sheet metal design by standardized mounting dimensions.
- Design with sufficient dielectric separation between terminals eliminates the need of any insulating sheet.

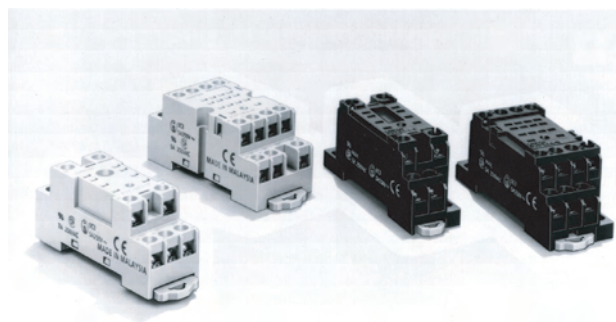

■ Safety Standards for Sockets

Model	Standards	File No.
PYF08A-E, PYF08A-N	UL508	E87929
PYF14A-E, PYF14A-N	CSA22.2	LR31928

Back-connecting Sockets

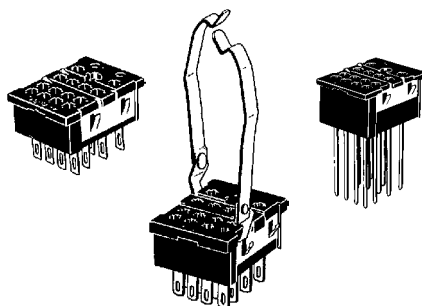

■ Specifications

Item	Pole	Model	Carry current	Dielectric withstand voltage	Insulation resistance (see note 2)
Screwless Clamp Terminal Socket	2	PYF08S	10 A	2,000 VAC, 1 min	Less than 1,000 MΩ
	4	PYF14S	5 A		
Track-mounted Socket	2	PYF08A-E	7 A	2,000 VAC, 1 min	1,000 MΩ min.
		PYF08A-N (see note 3)	7 A (see note 4)		
	4	PYF14A-E	5 A		
		PYF14A-N (see note 3)	5 A (see note 4)		
Back-connecting Socket	2	PY08(-Y1)	7 A	1,500 VAC, 1 min	100 MΩ min.
		PY08QN(-Y1)			
		PY08-02			
	4	PY14(-Y1)	3 A		
		PY14QN(-Y1)			
		PY14-02			

Note: 1. The values given above are initial values.

2. The values for insulation resistance were measured at 500 V at the same place as the dielectric strength.

3. The maximum operating ambient temperature for the PYF08A-N and PYF14A-N is 55°C.

4. When using the PYF08A-N or PYF14A-N at an operating ambient temperature exceeding 40°C, reduce the current to 60%.



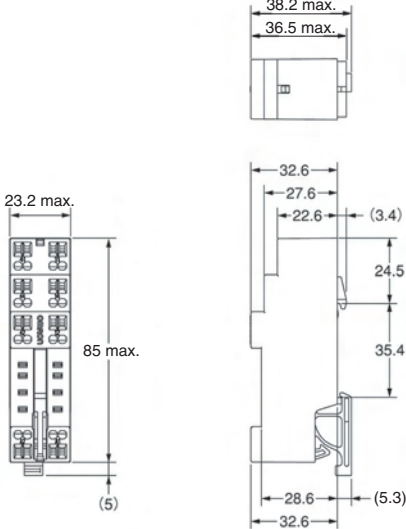
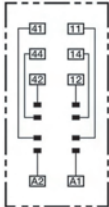
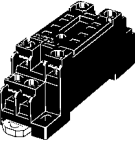
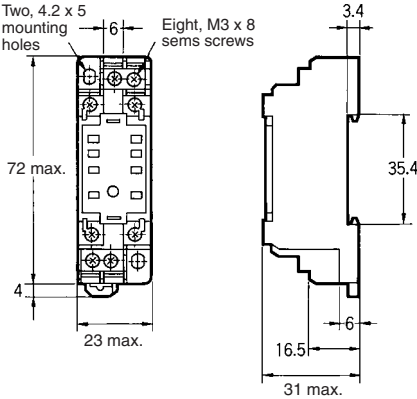
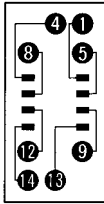
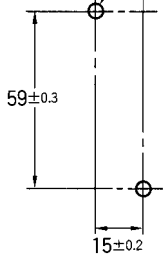
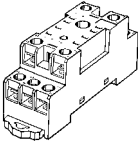
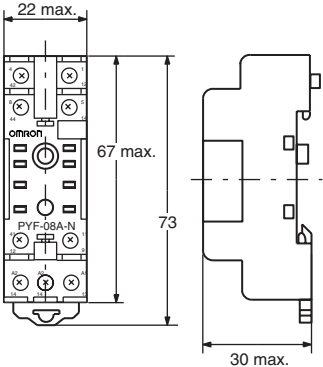
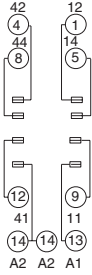
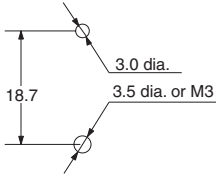

5. The MY2(S) can be used at 70°C with a carry current of 7 A.

■ Dimensions

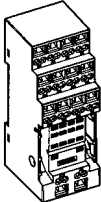
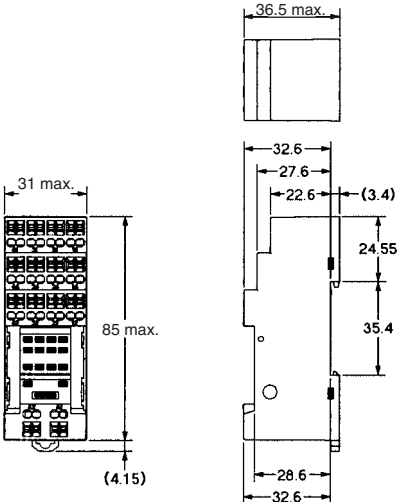
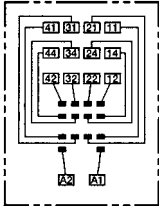
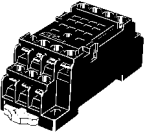
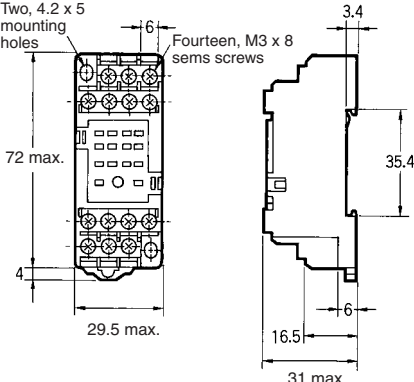
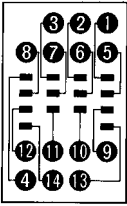
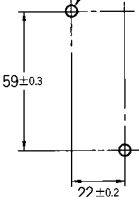
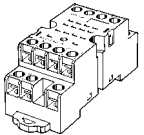
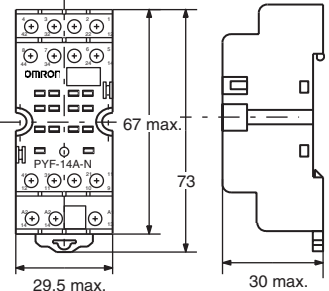
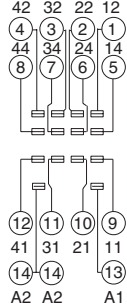
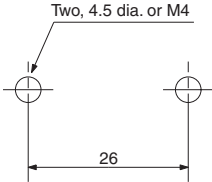
Note: All units are in millimeters unless otherwise indicated.

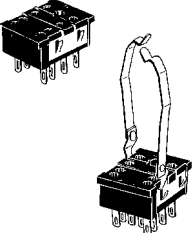
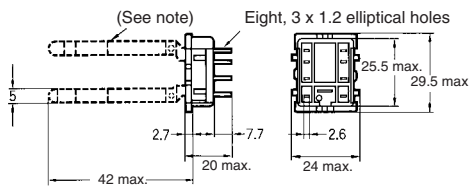
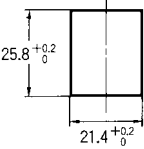
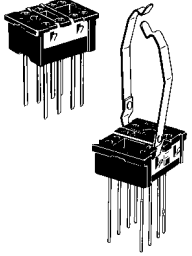
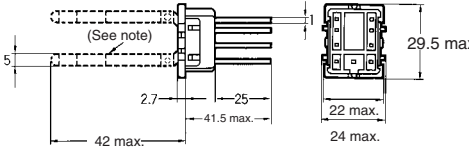
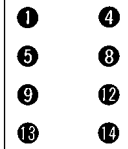
Socket	Dimensions	Terminal arrangement/ Internal connections (top view)	Mounting holes
<p>PYF08S</p> 			<p>---</p>
<p>PYF08A-E</p> 	<p>Two, 4.2 x 5 mounting holes</p> <p>Eight, M3 x 8 semi screws</p> 		<p>Two, M3, M4, or 4.5-dia. holes</p>  <p>(TOP VIEW)</p> <p>Note: Track mounting is also possible. Refer to page 12 for supporting tracks.</p>
<p>PYF08A-N</p> 			 <p>Note: Track mounting is also possible. Refer to page 12 for supporting tracks.</p>

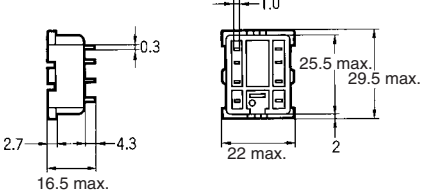
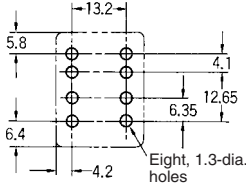
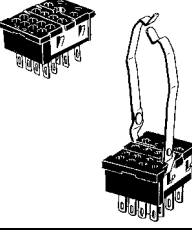
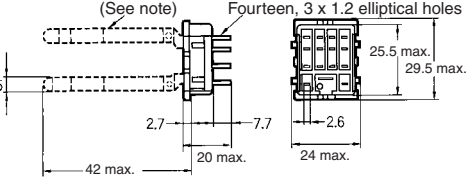
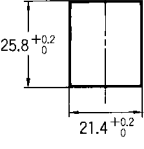
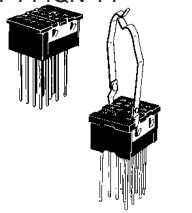
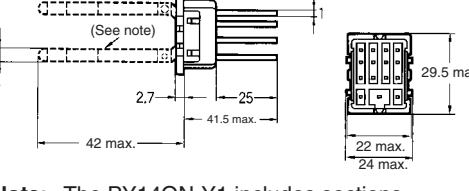
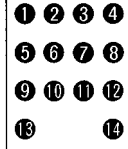
Socket	Dimensions	Terminal arrangement/ Internal connections (top view)	Mounting holes
<p>PYF14S</p> 			<p>---</p>
<p>PYF14A-E</p> 	<p>Two, 4.2 x 5 mounting holes</p> <p>Fourteen, M3 x 8 sems screws</p> 		<p>Two, M3, M4, or 4.5-dia. holes</p>  <p>(TOP VIEW)</p> <p>Note: Track mounting is also possible. Refer to page 12 for supporting tracks.</p>
<p>PYF14A-N</p> 			<p>Two, 4.5 dia. or M4</p>  <p>Note: Track mounting is also possible. Refer to page 12 for supporting tracks.</p>

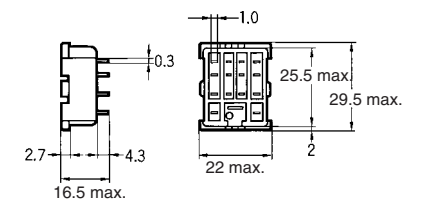
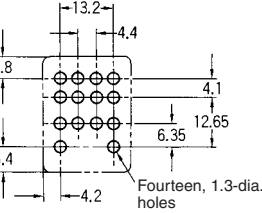
Socket	Dimensions	Terminal arrangement/ Internal connections (bottom view)	Mounting holes
<p>PY08/PY08-Y1</p> 	 <p>Note: The PY08-Y1 includes sections indicated by dotted lines.</p>		
<p>PY08QN/ PY08QN-Y1</p> 	 <p>Note: The PY08QN-Y1 includes sections indicated by dotted lines.</p>		
<p>PY08-02</p> 			
<p>PY14/PY14-Y1</p> 	 <p>Note: The PY14-Y1 includes sections indicated by dotted lines.</p>		
<p>PY14QN/ PY14QN-Y1</p> 	 <p>Note: The PY14QN-Y1 includes sections indicated by dotted lines.</p>		
<p>PY14-02</p> 			

Note: Use a panel with plate thickness of 1 to 2 mm for mounting the Sockets.

Hold-down Clips

PYC-A1
(2 pcs per set)

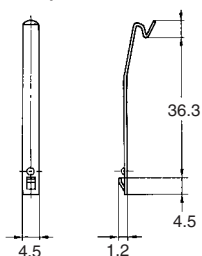

PYC-E1
(2 pcs per set)

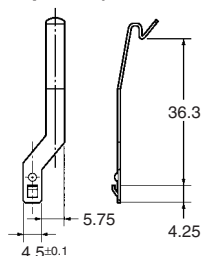

PYC-P

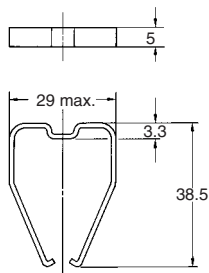

PYC-P2

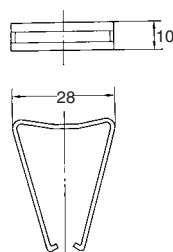

Mounting Plates for Back-connecting Sockets

PYP-1

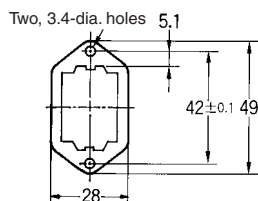

PYP-36

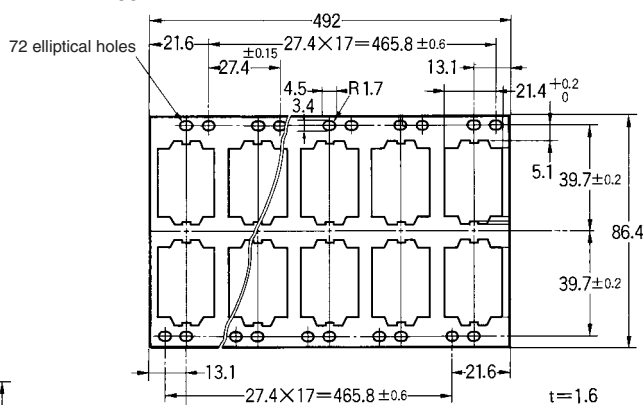

PYP-18

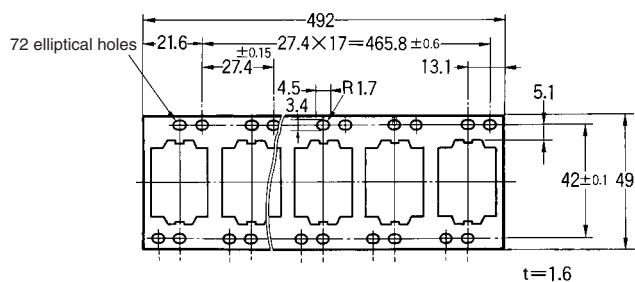

Tracks and Accessories

Supporting Tracks

PFP-50N/PFP-100N

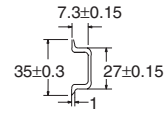
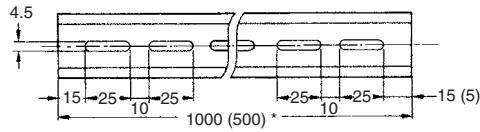
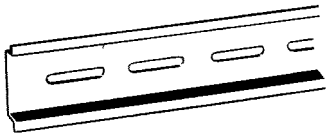

Note: The figure in the parentheses is for PFP-50N.

PFP-100N2

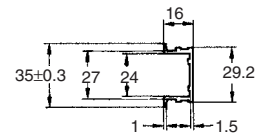
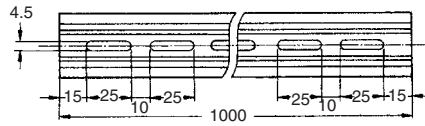
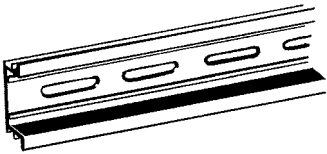

End Plate

PFP-M

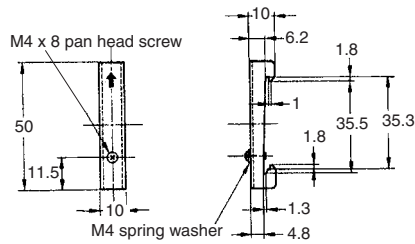
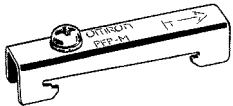

Spacer

PFP-S

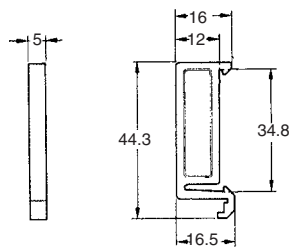
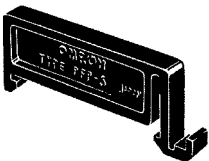

Precautions

Refer to *General Precautions* on page 11 of the *General-purpose Relays and Power Relays Group Catalog (X034)*.

■ Connections

Do not reverse polarity when connecting DC-operated Relays with built-in diodes or indicators or high-sensitivity DC-operated Relays.

■ Mounting

- Whenever possible, mount Relays so that it is not subject to vibration or shock in the same direction as that of contact movement.

ALL DIMENSIONS SHOWN ARE IN MILLIMETERS.

To convert millimeters into inches, multiply by 0.03937. To convert grams into ounces, multiply by 0.03527.

Cat. No. J111-E1-03 **In the interest of product improvement, specifications are subject to change without notice.**

OMRON RELAY & DEVICES Corporation

General Purpose Relay Division

Marketing & Product Engineering Department

1110 Sugi, Yamaga-City,

Kumamoto, 861-0596 Japan

Tel: (81)968-44-4160/Fax: (81)968-44-4107

Printed in Japan