



SYSDRIVE 3G3HV Series

High-capacity, General-purpose Inverter

Easy on Users, Easy on Equipment. The High-capacity, Easy-to-use Inverter.

Simple operations combined with full control capability.

A complete lineup to choose from.

Introducing an easier-to-use high-capacity inverter. The SYSDRIVE 3G3HV combines remarkable ease-of-use with advanced features and performance, such as energy-saving operation and PID control, that are expected of a high-capacity inverter. The lineup includes 12 models of the 200-V class ranging from 3.7 kW to 75 kW and 17 models of the 400-V class ranging from 3.7 kW to 300 kW.

This is the inverter you've been looking for.

Simple Operations that Anyone Can Use

■ Special Indicators for Basic Parameter Constants

Special indicators are provided for parameters, such as frequency settings and acceleration/deceleration times, that are fundamental to operation. For basic parameter constants, there is no need to check constant numbers one by one.

Energy-saving Operation

■ Energy-saving Control Mode

When the load is reduced, the 3-phase induction motor maintains its rotation speed even as the voltage is lowered. Using this mode, the 3G3HV detects the current to the motor, estimates the load, and automatically lowers the voltage to the most efficient level. This reduces power consumption and achieves energy savings.

- Fan Airflow Example

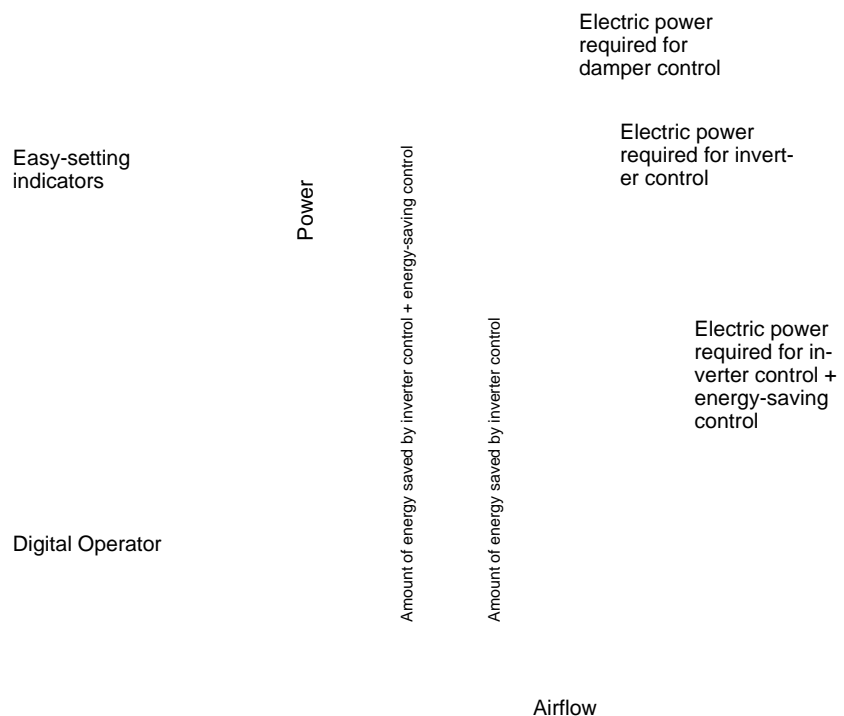

Caution

This catalog contains only the information required for selecting Inverter models, and not for actually operating them. Be sure to carefully read the relevant operation manuals before attempting to operate any of the equipment described here.

Precision Control

■ PID Control

PID (Proportional Integral Derivative) control makes it easy to operate motors at their highest efficiency, and, for example, to realize the optimum air flow (current flow) control for devices such as fan pumps.

■ Effective Harmonic Countermeasures for Power Supply

Models of 18.5 kW and over (both 200 V and 400 V) have built-in DC reactors and can handle 12-phase inputs, providing effective countermeasure guidelines for power supply harmonics. (When 12-phase control is used, a three-winding transformer is required for the power supply.)

Previous method:
6-phase control
No AC reactor
Current distortion
factor: 88%

12-phase control
With three-winding
transformer
Current distortion
factor: 12%

Table of Contents

Features
Applications
Digital Operator
Parameter Constants List
Parameter Constants
Specifications
Terminal Block
Dimensions
Wiring
Standard Models

A Complete Lineup to Choose From

■ 12 Models of the 200-V Class from 3.7 kW to 75 kW and 17 Models of the 400-V Class from 3.7 kW to 300 kW

200-V Class

- Enclosed wall-mounted type
3.7 kW, 5.5 kW, 7.5 kW, 11 kW, and 15 kW
- Open chassis type
18.5 kW, 22 kW, 30 kW, 37 kW, 45 kW, 55 kW, and 75 kW

400-V Class

- Enclosed wall-mounted type
3.7 kW, 5.5 kW, 7.5 kW, 11 kW, and 15 kW
- Open chassis type
18.5 kW, 22 kW, 30 kW, 37 kW, 45 kW, 55 kW, 75 kW, 110 kW, 160 kW, 185 kW, 220 kW, and 300 kW

**Easy-to-use
Inverter**

Applications

The easy-to-use Inverter's varied functions are useful in a wide range of applications.

■ General Conveyers (Conveyer Control)

- Production efficiency is improved by finding the optimum conveyer speed control for particular objects.
- The soft start/stop function can be used as required to prevent damage to loads and to ensure safe operation and consistent quality.

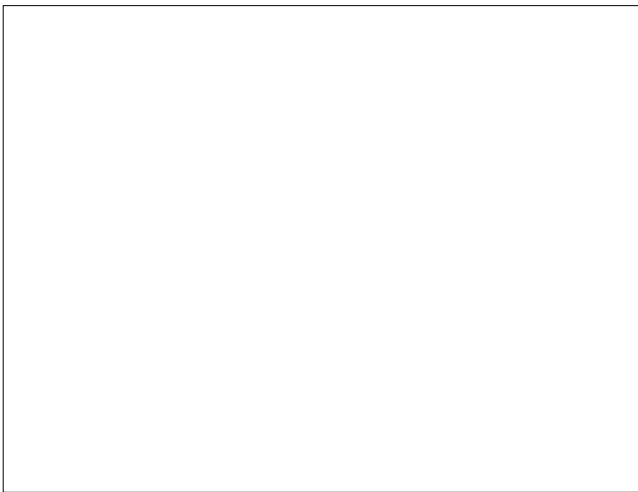

■ Pumps (Current Control)

- More efficient current control saves energy compared to controlling the amount of current by adjusting valves.
- Even during momentary power interruptions, using the speed search function continues operation without stopping the motor. This eliminates problems caused by motor stoppage.

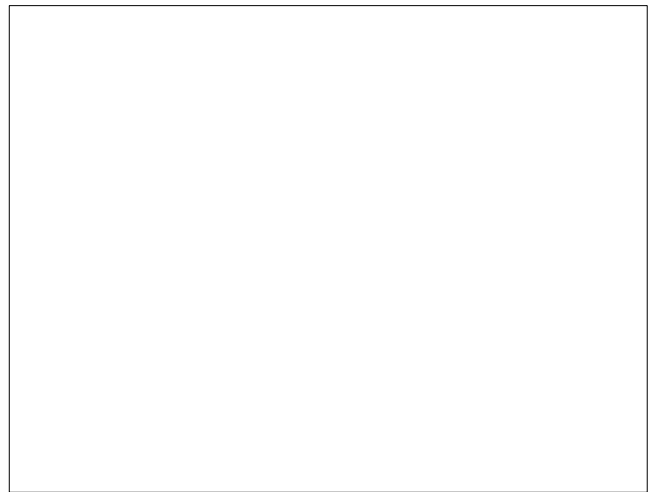

■ Fans (Air Flow Control)

- The optimum air flow control can be found according to the room temperature.
- No-contact air flow control improves safety and reliability compared to control based on the turning ON and OFF of contacts. And finding the optimum air flow also cuts down on energy usage.

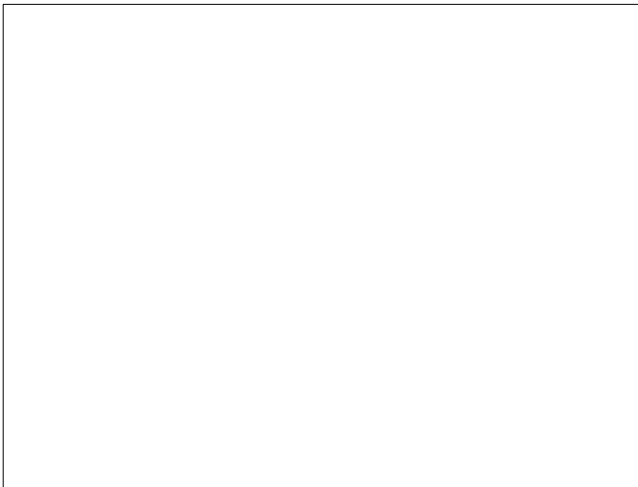

■ General Machinery (Machinery With Periodically Changing Loads)

- The energy-saving mode increases energy efficiency for machinery that has periodically changing loads.

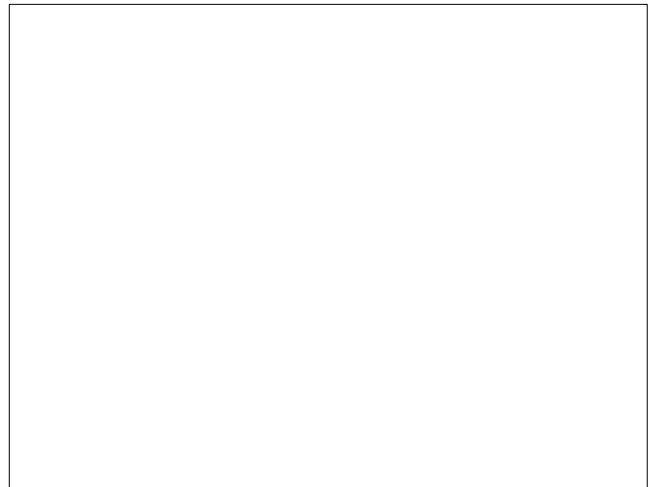

Digital Operator

■ Nomenclature and Functions

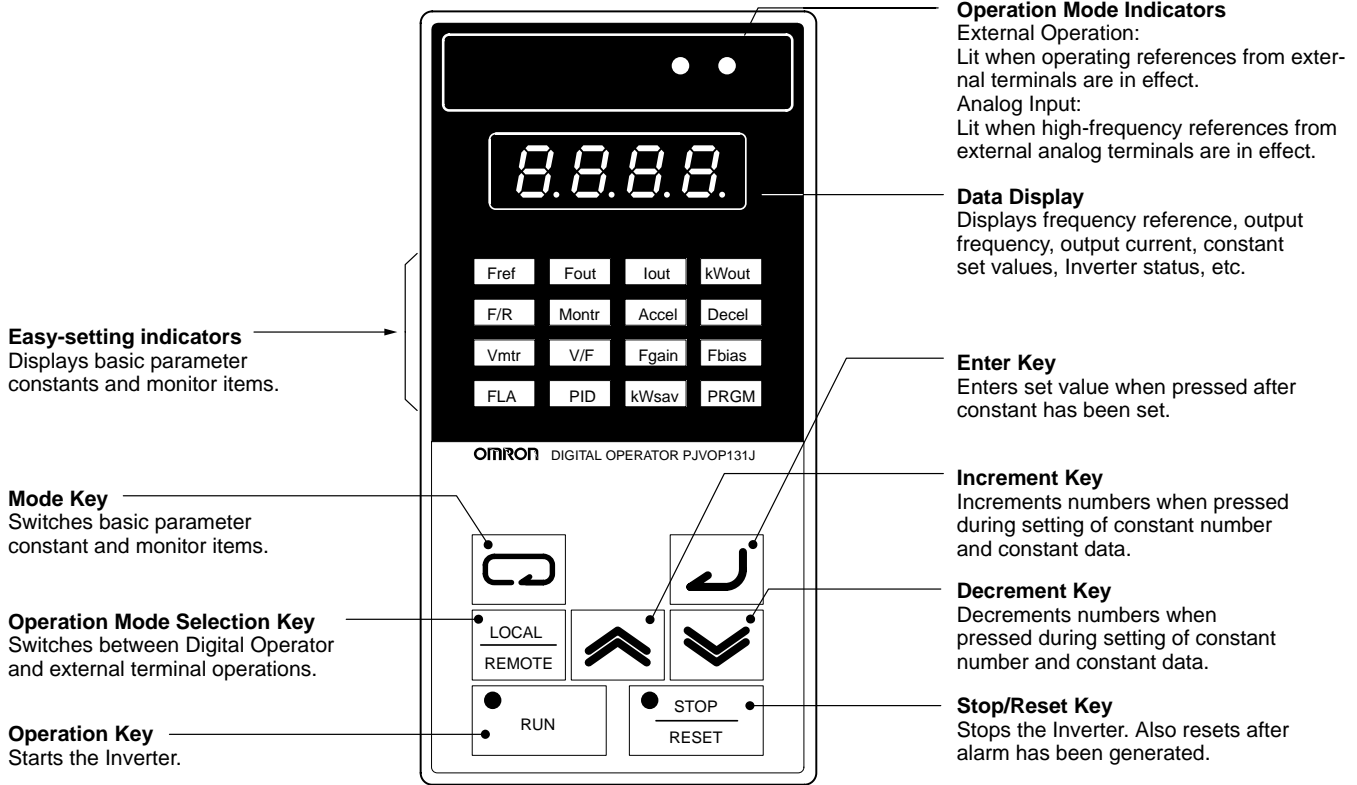

■ Switching Modes

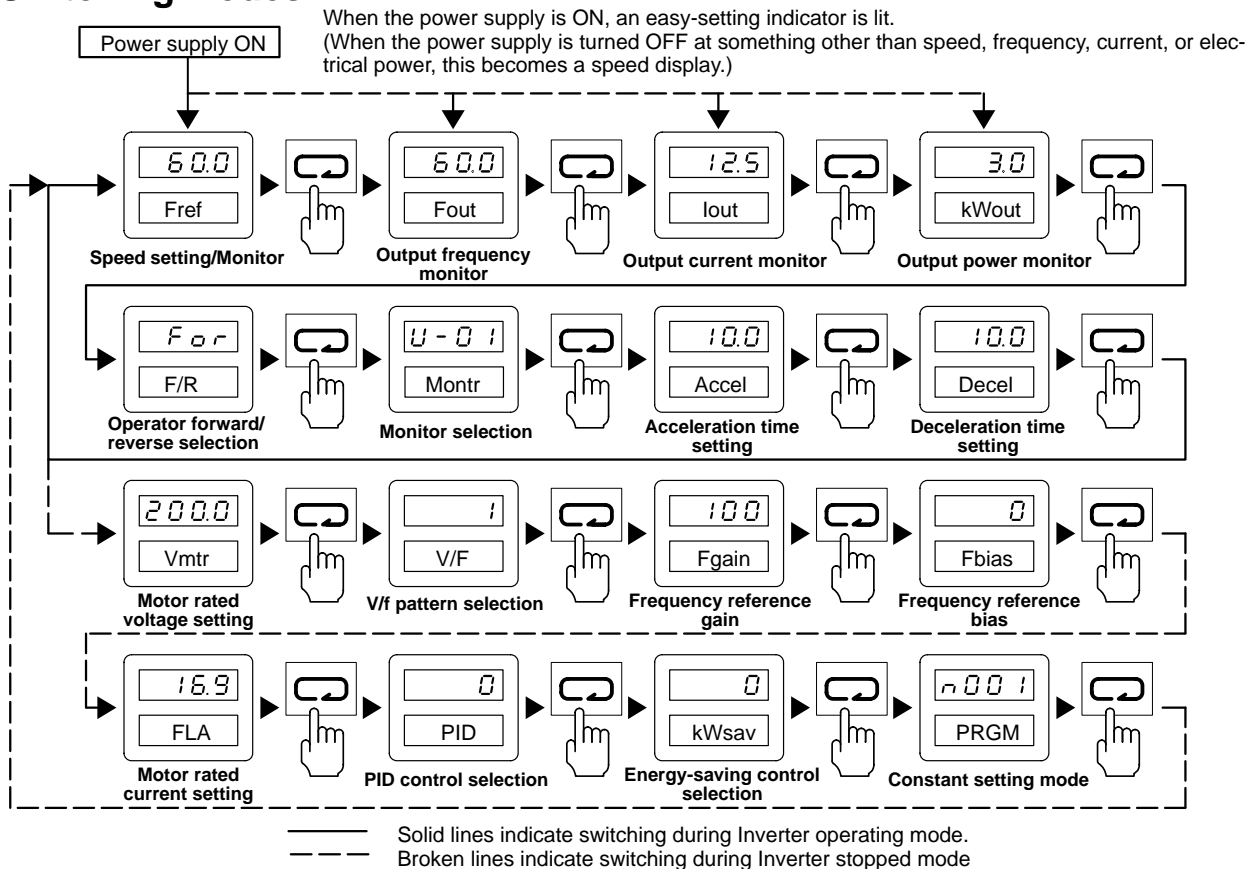

Digital Operator

Parameter Constant Setting

Setting Parameter Constants with Easy-setting Indicators

Example: Changing Acceleration Time From 10 s to 50 s

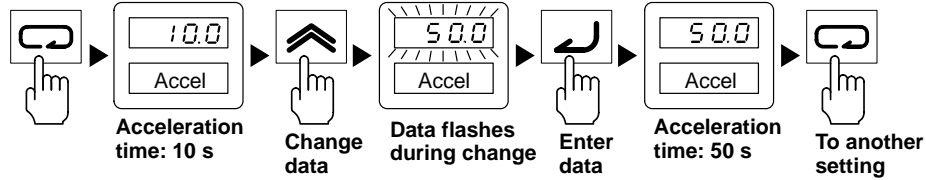

Setting Parameter Constants by Specifying Parameter Constant Number

Example: Setting Constant No. 025 (Frequency Reference 1)

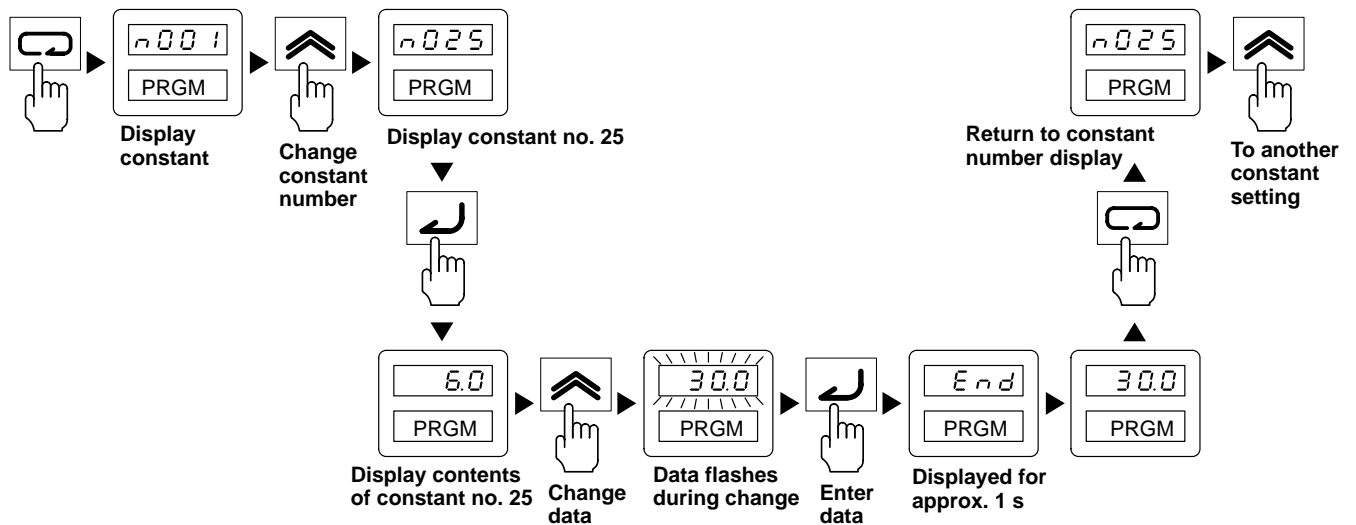

Checking Monitor Contents

Example: Checking Output Voltage (Monitor Item No. U-04)

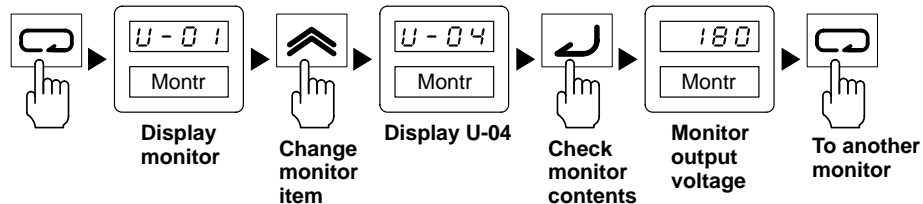

Monitor Display Table

Monitor No.	Monitor item
U-01	Frequency reference (same as easy-setting indicator's "speed")
U-02	Output frequency (same as easy-setting indicator's "frequency")
U-03	Output current (same as easy-setting indicator's "current")
U-04	Output voltage (V)
U-05	DC voltage (V)
U-06	Output power (same as easy-setting indicator's "power")
U-07	Input terminal status

Monitor No.	Monitor item
U-08	Inverter status
U-09	Error before power interruption (4 max.)
U-10	PROM number (rightmost 4 digits)
U-11	Total operating time (rightmost 4 digits)
U-12	Total operating time (leftmost 2 digits)
U-13	PID feedback value

Parameter Constants List

■ Parameter Constants List

No.	Name	Setting range	Unit	Factory setting
n001	Parameter write inhibit selection/Parameter initialization	0 to 7	---	1
n002	Operation mode selection	0 to 3	---	3
n003	Input voltage selection (see note 2)	150.0 to 255.0	V	200.0
n004	Interruption mode selection	0 to 3	---	0
n005	Forward/Reverse rotation selection	0, 1	---	0
n006	Reverse rotation-inhibit selection	0, 1	---	0
n007	Operation direction selection key permit/inhibit	0,1	---	1
n008	Stop Key function selection	0, 1	---	1
n009	Frequency reference type selection	0, 1	---	1
n010	V/f pattern selection	0 to F	---	1
n011	Motor rated voltage (see note 2)	150.0 to 255.0	V	200.0
n012	Maximum frequency	50.0 to 400.0	Hz	60.0
n013	Maximum voltage (see note 2)	0.1 to 255.0	V	200.0
n014	Maximum voltage frequency	0.2 to 400.0	Hz	60.0
n015	Intermediate output frequency	0.1 to 399.9	Hz	3.0
n016	Intermediate output frequency voltage (see note 2)	0.1 to 255.0	V	15.0
n017	Minimum output frequency	0.1 to 10.0	Hz	1.5
n018	Minimum output frequency voltage (see note 2)	0.1 to 50.0	V	10.0
n019	Acceleration time 1	0.0 to 3,600	s	10.0
n020	Deceleration time 1			
n021	Acceleration time 2			
n022	Deceleration time 2			
n023	S-shaped characteristic time selection	0 to 3	---	1
n024	Frequency reference selection/Reference	0 to 3,999	---	0
n025	Frequency reference 1	0 to maximum frequency	Set by n024.	6.0
n026	Frequency reference 2			0.0
n027	Frequency reference 3			0.0
n028	Frequency reference 4			0.0
n029	Inching frequency reference	0 to maximum frequency	Set by n024.	6.0
n030	Output frequency upper limit	0 to 100	%	100

No.	Name	Setting range	Unit	Factory setting
n031	Output frequency lower limit	0 to 100	%	0
n032	Motor rated current	See note 3	A	*
n033	Electronic thermal protective function selection	0 to 4	---	1
n034	Selection of stop method for when radiation fin overheats	0 to 3	---	3
n035	Multi-function input selection 1 (S2)	0 to 24	---	0
n036	Multi-function input selection 2 (S3)	2 to 24	---	2
n037	Multi-function input selection 3 (S4)	2 to 24	---	4
n038	Multi-function input selection 4 (S5)	2 to 24	---	9
n039	Multi-function input selection 5 (S6)	2 to 25	---	10
n040	Multi-function contact output 1	0 to 17	---	0
n041	Multi-function contact output 2	0 to 17	---	1
n042	Analog frequency reference voltage/current selection	0, 1	---	0
n043	Fl input level selection	0, 1	---	1
n044	Analog frequency reference sample hold selection	0, 1	---	0
n045	Processing selection when analog frequency reference is lost	0, 1	---	0
n046	Frequency reference gain	0 to 200	%	100
n047	Frequency reference bias	-100 to 100	%	0
n048	Multi-function analog output selection	0 to 3	---	0
n049	Multi-function analog output gain	0.01 to 2.00	Factors	1.00
n050	Carrier frequency	1 to 9	---	*
n051	Selection of operation after restoration following a momentary stop	0 to 2	---	0
n052	Speed search operation level	0 to 200	%	150
n053	Minimum baseblock time	0.5 to 5.0	s	*
n054	V/f characteristics during speed search	0 to 100	%	*
n055	Stop compensation time	0.0 to 2.0	s	*
n056	Number of error retries	0 to 10	Times	0

Parameter Constants List

No.	Name	Setting range	Unit	Factory setting
n057	Selection of error output during error retry	0, 1	---	0
n058	Jump frequency 1	0.0 to 400.0	Hz	0.0
n059	Jump frequency 2			
n060	Jump frequency range	0.0 to 25.5	Hz	1.0
n061	Total operating time function selection	0, 1	---	1
n062	Total operating time 1 (rightmost 4 digits)	0 to 9,999	h	0
n063	Total operating time 2 (leftmost 2 digits)	0 to 27	x10,000 h	0
n064	DC braking current	0 to 100	%	50
n065	Stopped DC braking time	0.0 to 10.0	s	0.5
n066	Startup DC braking time	0.0 to 10.0	s	0.0
n067	Automatic torque boost gain	0.0 to 3.0	Factors	1.0
n068	Motor winding resistance	0.000 to 65.53	Ω	*
n069	Motor iron loss	0 to 9,999	W	*
n070	Decelerating stall prevention selection	0, 1	---	1
n071	Accelerating stall prevention operation level	30 to 200	%	170
n072	Operating stall prevention operation level	30 to 200	%	160
n073	Frequency detection level	0.0 to 400.0	Hz	0.0
n074	Overtorque detection function selection	0 to 4	---	0
n075	Overtorque detection level	30 to 200	%	160
n076	Overtorque detection time	0.1 to 10.0	s	0.1
n077	Timer function ON delay time	0.0 to 25.5	s	0.0
n078	Timer function OFF delay time	0.0 to 25.5	s	0.0
n079	Braking resistor overheating protection selection	0, 1	---	0
n080	Input open-phase detection level	1 to 100	%	7
n081	Input open-phase detection time	2 to 255	x 1.28 s	8
n082	Output open-phase detection level	0 to 100	%	0

No.	Name	Setting range	Unit	Factory setting
n083	Output open-phase detection time	0.0 to 2.0	s	0.2
n084	PID control function selection	0 to 2	---	0
n085	Feedback adjustment gain	0.00 to 10.00	Factors	1.00
n086	Proportional gain (P)	0.0 to 10.0	Factors	1.0
n087	Integral time (I)	0.0 to 100.0	s	10.0
n088	Differential time (D)	0.00 to 1.00	s	0.00
n089	PID offset adjustment	-109 to 109	%	0
n090	Integral (I) upper limit	0 to 109	%	100
n091	PID primary delay constant	0.0 to 2.5	s	0.0
n092	Feedback loss detection selection	0, 1	---	0
n093	Feedback loss detection level	0 to 100	%	0
n094	Feedback loss detection time	0.0 to 25.5	s	1.0
n095	Energy-saving control selection	0, 1	---	0
n096	Energy-saving coefficient K2	0.00 to 655.0	---	*
n097	Energy-saving voltage lower limit for 60 Hz	0 to 120	%	50
n098	Energy-saving voltage lower limit for 6 Hz	0 to 25	%	12
n099	Mean power time	1 to 200	x 25 ms	1
n100	Search operation voltage limit	0 to 100	%	0
n101	Search operation control voltage step when 100%	0.0 to 10.0	%	0.5
n102	Search operation control voltage step when 5%	0.0 to 10.0	%	0.2

- Note:**
1. Factory settings for items marked by asterisks vary according to the Inverter model.
 2. With 400-V Inverters, the setting range upper limits and factory settings are double those shown in the table.
 3. The motor's rated voltage setting range is 10% to 200% of the Inverter's rated current.

Parameter Constants

Speed	n025 to n028	Frequency references 1 to 4
--------------	--------------	------------------------------------

Frequency references can be set internally.

Item	Setting contents
Setting range	0 to maximum frequency
Setting unit	Set by n024. (The factory setting is for units of 0.1 Hz.)
Factory settings	n025 only: 6.0 Hz; others: 0.0 Hz

Note: Multistep operation of up to four steps can be specified by setting the multistep speed references to multifunction input.

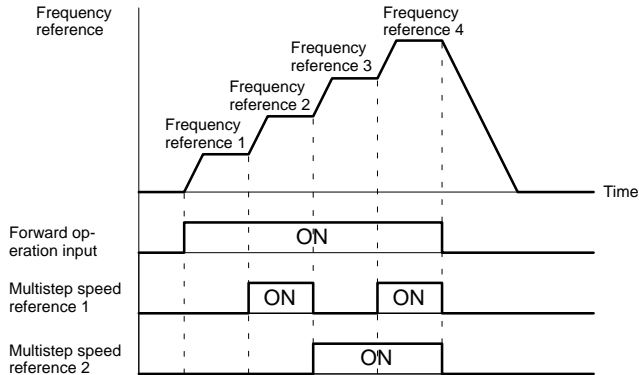

Direction	Operator Forward/Reverse Selection
------------------	---

This setting switches the direction of operation when the Digital Operator is being used.

Set value	Setting contents
f%r	Forward operation
reU	Reverse operation

Acceleration	n019, n021	Acceleration Times 1, 2
Deceleration	n020, n022	Deceleration Times 1, 2

Acceleration and deceleration times can be set within a wide range, from 0.0 to 3,600 s.

Acceleration Time: Can be set from 0% to 100% of the maximum frequency.

Deceleration Time: Can be set from 100% to 0% of the maximum frequency.

Item	Setting contents
Setting range	0 to 3,600 s
Setting unit	0.01 s (less than 1,000 s); 1 s (1,000 s or more)
Factory setting	10.0 s

Note: Acceleration time 2 and deceleration time 2 can be used by setting the multi-step speed references to multifunction input.

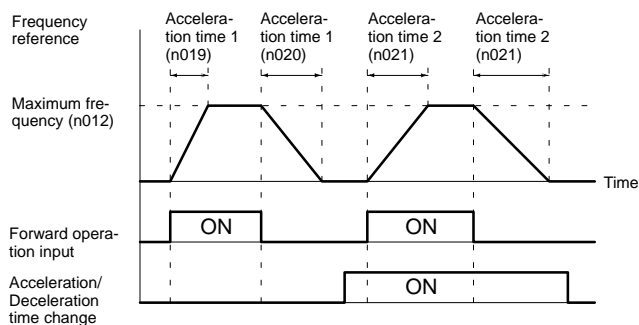

Motor Voltage	n011	Motor Rated Voltage
----------------------	------	----------------------------

This parameter sets the rated voltage for the motor.

Item	Setting contents
Setting range	150.0 to 255.0 V (155.0 to 515.0 V)
Setting unit	0.1 V
Factory settings	200.0 V (400.0 V)

Note: Values in parentheses indicate 400-V function settings.

V/f	n010	V/f Pattern Selection
------------	------	------------------------------

Any of 15 types of V/f patterns can be selected.

Item	Setting contents
Setting range	0 to F
Factory settings	1

- Note:**
1. The user can select from among 15 preset V/f patterns (0 to E).
 2. When "F" is set, any V/f pattern can be specified. At that time, parameters n012 through n018 will be valid.
 3. The parameters related to V/f pattern settings are shown in the following table.

Parameter No.	Contents
n012	Maximum frequency (FMAX)
n013	Maximum voltage (VMAX)
n014	Maximum voltage frequency (FA)
n015	Intermediate output frequency (FB)
n016	Intermediate output frequency voltage (VC)
n017	Minimum output frequency (FMIN)
n018	Minimum output frequency voltage (VMIN)

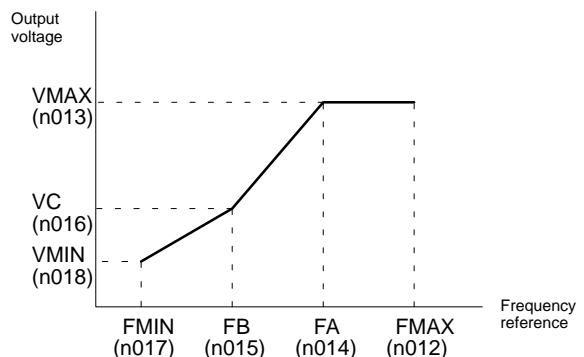

Parameter Constants

Gain	n046	Frequency reference gain
Bias	n047	Frequency reference bias

Any frequency reference relationship can be set for for analog inputs (0 to 10 V or 4 to 20 mA).

Parameter	Contents
n046 Frequency reference gain	Sets the frequency for when the frequency reference voltage (current) is 10 V (20 mA), with the maximum frequency (n012) taken as 100%. Setting range: 0 to 200% (unit: 1%) Factory setting: 100%
n047 Frequency reference bias	Sets the frequency for when the frequency reference voltage (current) is 0 V (4 mA), with the maximum frequency (n012) taken as 100%. Setting range: -100 to 100% (unit: 1%) Factory setting: 0%

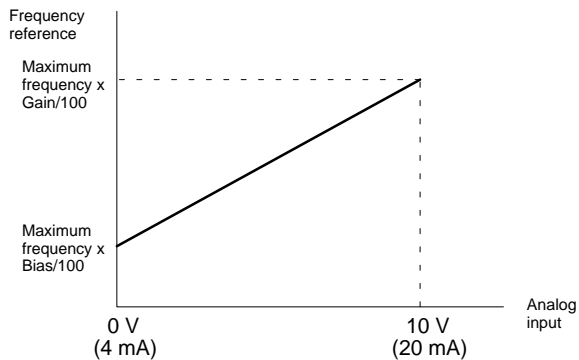

Note: The values in parentheses are for current input.

Motor Current	n032	Motor Rated Current
----------------------	------	----------------------------

This parameter sets the motor's rated current. The value set here will be the standard current for electronic thermal motor protection.

Item	Setting contents
Setting range	10% to 200% of Inverter's rated current
Setting unit	0.1 A
Factory settings	Varies depending on Inverter model.

PID	n084	PID Control Function Selection
------------	------	---------------------------------------

Set value	Setting contents
0	Without PID control.
1	With PID control. (D control for deviation.)
2	With PID control. (D control for feedback value.)

Note: The factory setting is "0" (without PID control).

Functions

- With the 3G3HV, PID control allows for easy follow-up control.
- Follow-up control is a control method whereby sensing values from sensors are sent to the Inverter as feedback, and the Inverter's frequency is changed to match standard values from references.
- Sensing values from sensors can be used for various types of control, depending on their contents.

Valid Applications

- **Speed Control:**
Using speed sensors such as tachogenerators, speeds can be uniformly controlled regardless of the size of the load, and they can be synchronized with the speeds of other motors.
- **Pressure Control:**
Pressure can be uniformly controlled by means of feedback from pressure sensors.
- **Current Control:**
Precise current control is made possible by current sensing.
- **Temperature Control:**
Temperatures can be controlled by fans that are turned based on feedback from temperature sensors.

Related Parameters

Parameter No.	Contents
n085	Sensing adjustment gain
n086	Proportional gain (P)
n087	Integral time (I)
n088	Differential time (D)
n089	PID offset adjustment
n090	Integral (I) upper limit
n091	PID primary delay constant
n092	Feedback loss detection selection
n093	Feedback loss detection level
n094	Feedback loss detection time

Parameter Constants

Energy Saving	n095	Energy-saving Control Selection
Set value	Setting contents	
0	Energy-saving control disabled.	
1	Energy-saving control enabled.	

Note: The factory setting is "0" (energy-saving control disabled).

Functions

- The power ratio of inductive motors changes depending on the rotation speed and the load. In general, the rated load and rated rotation speed are set for a high power ratio. If the rotation speed is low or the load is reduced, the power ratio drops and the motor becomes loses efficiency. Lowering the power supply voltage to match the load and rotation speed allows the motor to be operated at the maximum power ratio and increased efficiency.
- With the 3G3HV, energy-saving operation can be implemented automatically by simply selecting the energy-saving mode.
- Existing motors can be operated with the factory-set energy-saving coefficients even if the motor constants are not known (except for special motors such as underwater or spindle motors).

Valid Applications

- Air flow control for fans, blocks, etc.
- Flow control for pumps.
- Machinery with periodic load changes:
 - Construction equipment
 - Woodworking machinery
 - Food processing equipment, etc.

Related Parameters

Parameter No.	Contents
n096	Energy-saving coefficient K2
n097	Energy-saving voltage lower limit for 60-Hz output
n098	Energy-saving voltage lower limit for 6-Hz output
n099	Electrical power average time
n100	Search operation voltage limit
n101	Search operation control voltage step when 100%
n102	Search operation control voltage step when 5%

Search Operation

- The search operation changes the output voltage in small increments and seeks the point at which electrical power is at a minimum.
- For example, if the motor constant is changed during operation due to a temperature change, the optimum running conditions will change, resulting in a deviation from the optimum operation. The search operation prevents this from occurring.
- The search operation can be used to provide the optimum voltage even if the motor constant is different from the factory setting.

Specifications

■ Specifications

200-V Inverters

General Specifications

Model	3G3HV-	A2037 -E	A2055 -E	A2075 -E	A2110 -E	A2150 -E	B2185 -E	B2220 -E	B2300 -E	B2370 -E	B2450 -E	B2550 -E	B2750 -E
Maximum applicable motor capacity (kW)		3.7	5.5	7.5	11	15	18.5	22	30	37	45	55	75
Output characteristics	Rated output capacity (kVA)	6.7	9.5	13	19	24	30	37	50	61	70	85	110
	Rated output current (A)	17.5	25	33	49	64	80	96	130	160	183	224	300
	Maximum output voltage (V)	3-phase, 200 to 230 VAC (Corresponds to input voltage.)											
	Maximum output frequency (Hz)	400 Hz (Set by parameter constant.)											
Power supply characteristics	Rated voltage (V) Rated frequency (Hz)	3-phase, 200 to 230 VAC, 50/60 Hz											
	Allowable voltage fluctuation	-15% to 10%											
	Allowable frequency fluctuation	±5%											
Heat generated (kW)		0.22	0.30	0.35	0.59	0.73	0.89	1.2	1.4	1.8	2.1	2.7	3.3
Weight (kg)		Approx. 4.5	Approx. 5.5	Approx. 6.0	Approx. 11	Approx. 11	Approx. 28	Approx. 28	Approx. 61	Approx. 62	Approx. 80	Approx. 80	Approx. 135

Control Characteristics

Model	3G3HV-	A2037 -E	A2055 -E	A2075 -E	A2110 -E	A2150 -E	B2185 -E	B2220 -E	B2300 -E	B2370 -E	B2450 -E	B2550 -E	B2750 -E
Power supply harmonic countermeasures		DC reactor connection possible.						DC reactor built in. 12-pulse rectification input					
Control method		Sine wave PWM (high-carrier frequency control)											
Carrier frequency		2.5 to 15 kHz (Step setting)						2.5 to 10 kHz (Step setting)					
Frequency control range		0.1 to 400 Hz											
Frequency precision (temperature characteristics)		Digital commands: ±0.01% (-10° to 40°C) Analog commands: ±0.1% (25±10°C)											
Frequency setting resolution		Digital commands: 0.1 Hz Analog commands: 0.6 Hz/60 Hz (1/1,000 or equivalent)											
Output frequency resolution		0.01 Hz											
Overload capacity		150% of rated current for one minute						120% of rated current for one minute					
Frequency setting signal		0- to 10-VDC (20 kΩ) voltage input or 4- to 20-mA (250 Ω) current input											
Acceleration/Deceleration time		0.0 to 3,600 s (acceleration and deceleration set separately)											
Braking torque		Approx. 20% (Up to 125% possible with external braking resistor.)						Approx. 20% (External braking resistor cannot be attached.)					
Voltage/frequency characteristics		Select from 15 types of fixed V/f patterns or set any V/f pattern.											

Protective Functions

Model	3G3HV-	A2037 -E	A2055 -E	A2075 -E	A2110 -E	A2150 -E	B2185 -E	B2220 -E	B2300 -E	B2370 -E	B2450 -E	B2550 -E	B2750 -E
Motor protection		Protection by electronic thermal.											
Instantaneous overcurrent protection		Stops at approx. 200% of rated output current.						Stops at approx. 180% of rated output current.					
Overload protection		Stops in one minute at approx. 150% of rated output current.						Stops in one minute at approx. 120% of rated output current.					
Overvoltage protection		Stops when main-circuit DC voltage is approx. 410 V.											
Undervoltage protection		Stops when main-circuit DC voltage is approx. 190 V.											
Momentary power interruption compensation (selection)		Stops at 15 ms or more. By means of an operating mode selection, operation can be continued if recovery occurs within 2 seconds.											
Cooling fin overheating		Protection by thermistor.											
Grounding protection		Protection by electronic circuits.											
Charge indicator (internal LED)		Lit when rated DC voltage is approx. 50 V or more.											

Environment

Model	3G3HV-	A2037 -E	A2055 -E	A2075 -E	A2110 -E	A2150 -E	B2185 -E	B2220 -E	B2300 -E	B2370 -E	B2450 -E	B2550 -E	B2750 -E
Location		Indoors (no corrosive gas, oil spray, metallic dust, etc.)											
Ambient operating temperature		-10° to 45°C (Enclosed wall-mounted type: -10° to 40°C)						-10° to 45°C (Open-chassis type)					
Ambient operating humidity		90% RH (with no condensation)											
Storage temperature		-20° to 60°C											
Altitude		1,000 m max.											
Insulation resistance		5 MΩ min. (Do not carry out the insulation resistance test or withstand voltage test.)											
Vibration withstand		Vibration frequency less than 20 Hz, 9.8 m/s ² max.; 20 to 50 Hz, 2 m/s ² max											
Protective structure		Both enclosed wall-mounted type and open-chassis type: IP10						Open-chassis type: IP00					

Function for Setting an Input Constant

400-V Inverters

General Specifications

Model	3G3HV-	A4037 -E	A4055 -E	A4075 -E	A4110 -E	A4150 -E	B4185 -E	B4220 -E	B4300 -E	B4370 -E	B4450 -E	B4550 -E	B4750 -E	B411K -E	B416K -E	B418K -E	B422K -E	B430K -E	
Maximum applicable motor capacity (kW)		3.7	5.5	7.5	11	15	18.5	22	30	37	45	55	75	110	160	185	220	300	
Output characteristics	Rated output capacity (kVA)	6.1	11	14	21	26	31	40	50	61	73	98	130	170	230	260	340	460	
	Rated output current (A)	8	14	18	27	34	41	52	65	80	96	128	165	224	302	340	450	605	
	Maximum output voltage (V)	3-phase, 380 to 460 VAC (Corresponds to input voltage.)																	
	Maximum output frequency (Hz)	400 Hz (Set by parameter constant.)																	
Power supply characteristics	Rated voltage (V)	3-phase, 380 to 460 VAC, 50/60 Hz																	
	Rated frequency (Hz)																		
	Allowable voltage fluctuation	-15 to 10%																	
Allowable frequency fluctuation	±5%																		
Heat generated (kW)		0.15	0.22	0.36	0.46	0.57	0.66	0.88	1.1	1.3	1.4	1.9	2.4	3.1	4.2	5.0	6.9	9.8	
Weight (kg)		Approx. 4.5	Approx. 6.0	Approx. 6.0	Approx. 11	Approx. 11	Approx. 27	Approx. 27	Approx. 44	Approx. 44	Approx. 44	Approx. 79	Approx. 80	Approx. 135	Approx. 145	Approx. 360	Approx. 360	Approx. 420	

Control Characteristics

Model	3G3HV-	A4037 -E	A4055 -E	A4075 -E	A4110 -E	A4150 -E	B4185 -E	B4220 -E	B4300 -E	B4370 -E	B4450 -E	B4550 -E	B4750 -E	B411K -E	B416K -E	B418K -E	B422K -E	B430K -E	
Power supply harmonic counter-measures		DC reactor connection possible.						DC reactor built-in 12-pulse rectification input						No item					
Control method		Sine wave PWM (high-carrier frequency control)																	
Carrier frequency		2.5 to 15 kHz (Step setting)									2.5 to 10 kHz (Step setting)								
Frequency control range		0.1 to 400 Hz																	
Frequency precision (temperature characteristics)		Digital commands: ±0.01% (-10° to 40°C)						Analog commands: ±0.1% (25°C±10°C)											
Frequency setting resolution		Digital commands: 0.1 Hz						Analog commands: 0.6 Hz/60 Hz (1/1,000 or equivalent)											
Output frequency resolution		0.01 Hz																	
Overload capacity		150% of rated current for one minute									120% of rated current for one minute								
Frequency setting signal		0- to 10-VDC (20 kΩ) voltage input or 4- to 20-mA (250 Ω) current input																	
Acceleration/Deceleration time		0.0 to 3,600 s (acceleration and deceleration set separately)																	
Braking torque		Approx. 20% (Up to 125% possible with external braking resistor.)									Approx. 20% (External braking resistor cannot be attached.)						Approx. 20% (Up to 100% possible with external braking resistor.)		
Voltage/frequency characteristics		Select from 15 types of fixed V/f patterns or set any V/f pattern.																	

Protective Functions

Model	3G3HV-	A4037 -E	A4055 -E	A4075 -E	A4110 -E	A4150 -E	B4185 -E	B4220 -E	B4300 -E	B4370 -E	B4450 -E	B4550 -E	B4750 -E	B411K -E	B416K -E	B418K -E	B422K -E	B430K -E	
Motor protection		Protection by electronic thermal.																	
Instantaneous overcurrent protection		Stops at approx. 200% of rated output current.						Stops at approx. 180% of rated output current.											
Overload protection		Stops in one minute at approx. 150% of rated output current.						Stops in one minute at approx. 120% of rated output current.											
Overvoltage protection		Stops when main-circuit DC voltage is approx. 820 V.																	
Undervoltage protection		Stops when main-circuit DC voltage is approx. 380 V.																	
Momentary power interruption compensation (selection)		Stops at 15 ms or more. By means of an operating mode selection, operation can be continued if recovery occurs within 2 seconds.																	
Cooling fin overheating		Protection by thermistor.																	
Grounding protection		Protection by electronic circuits.																	
Charge indicator (internal LED)		Lit when rated DC voltage is approx. 50 V or more.																	

Environment

Model	3G3HV-	A4037 -E	A4055 -E	A4075 -E	A4110 -E	A4150 -E	B4185 -E	B4220 -E	B4300 -E	B4370 -E	B4450 -E	B4550 -E	B4750 -E	B411K -E	B416K -E	B418K -E	B422K -E	B430K -E	
Location		Indoors (no corrosive gas, oil spray, metallic dust, etc.)																	
Ambient operating temperature		-10° to 45°C (Enclosed wall-mounted type: -10° to 40°C)						-10° to 45°C (Open-chassis type)											
Ambient operating humidity		90% RH (with no condensation)																	
Storage temperature		-20° to 60°C																	
Altitude		1,000 m max.																	
Insulation resistance		5 MΩ min. (Do not carry out the insulation resistance test or withstand voltage test.)																	
Vibration withstand		Vibration frequency less than 20 Hz, 9.8 m/s ² max.; 20 to 50 Hz, 2 m/s ² max																	
Protective structure		Both enclosed wall-mounted type and open-chassis type: IP10									Open-chassis type: IP00								

Terminal Block

Terminal Block Configuration

Example: 200 V, 3.7 kW

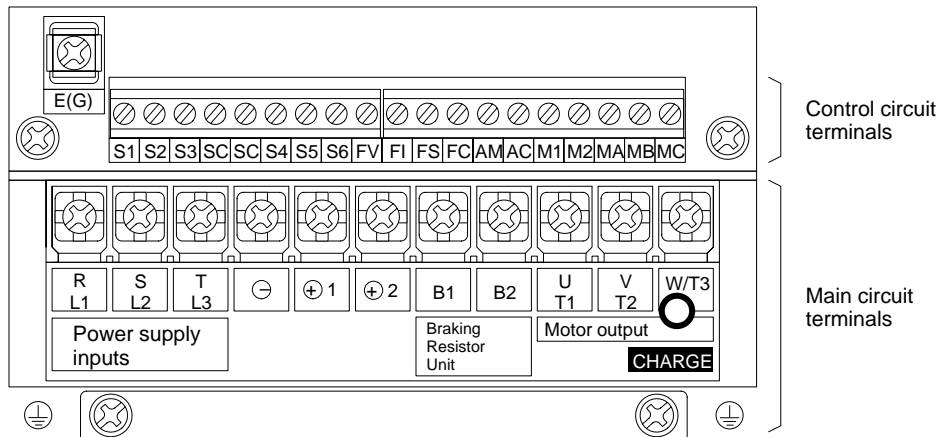

Main Circuit Terminals

Voltage class Model 3G3HV- Symbol Capacity	200-V Class			400-V Class		
	2037-E to -A2075-E 3.7 to 7.5 kW	A2110-E to -A2150-E 11 to 15 kW	B2185-E to -B2750-E 18.5 to 75 kW	A4037-E to -A4150-E 3.7 to 15 kW	B4185-E to -B416K-E 18.5 to 160 kW	B418K-E to -B430K-E 185 to 300 kW
R, S, T	Power supply input terminals, 3-phase, 200 to 230 VAC, 50/60 Hz			Power supply input terminals, 3-phase, 380 to 460 VAC, 50/60 Hz		
R1, S1, T1	---			(See note)		
U, V, W	Motor output terminals, 3-phase, 200 to 230 VAC (correspond to input voltage)			Motor output terminals, 3-phase, 380 to 460 VAC (corresponds to input voltage)		
B1 B2	Braking Resistor Unit connection terminals			Braking Resistor Unit connection terminals		
+1	DC reactor connection terminal		---	DC reactor connection terminal		DC reactor connection terminal
+2	---			---		
+3	---	Braking Unit connection terminals		---		Braking Unit connection terminals
⊕	Ground terminal (Ground to 100 Ω or less.)			Ground terminal (Ground to 10 Ω or less.)		

Note: Connect the R1, S1, and T1 terminals to the R, S, and T terminals respectively. (They are short-circuited with short bars when shipped from the factory.)

Control Circuit Terminal

Common to Both 200-V and 400-V Classes

Symbol	Name	Function	Signal level
Input	S1	Forward/Stop	Stops at OFF.
	S2	Multi-function input 1 (S2)	Set by constant n035 (reverse/stop).
	S3	Multi-function input 2 (S3)	Set by constant n036 (external error a).
	S4	Multi-function input 3 (S4)	Set by constant n037 (error reset).
	S5	Multi-function input 4 (S5)	Set by constant n038 (multistep speed reference 1).
	S6	Multi-function input 5 (S6)	Set by constant n039 (multistep speed reference 2).
	SC	Sequence input common	Common for S1 to S6.
	FS	Frequency reference power supply	DC power supply for frequency reference.
	FV	Frequency reference input (voltage)	Voltage input terminal for frequency reference.
	FI	Frequency reference input (current)	Current input terminal for frequency reference.
	FC	Frequency reference input common	Common for FV, FI.
G	Shielded wire connection ground	Shielded terminal for sequence and frequency reference inputs.	
Output	MA	Multi-function contact output 1 (normally open)	Bit output 30 VDC, 1 A max. 250 VAC, 1 A max.
	MB	Multi-function contact output 1 (normally closed)	
	MC	Multi-function contact output 1 common	
	M1	Multi-function contact output 2 (normally open)	Common for M1
	M2	Multi-function contact output 2 common	
	AM	Multi-function analog output	Set by constant n048 (output frequency)
	AC	Multi-function analog output common	Common for AM

Dimensions

■ Dimensions

3G3HV-A2□□□□/A4□□□□-E

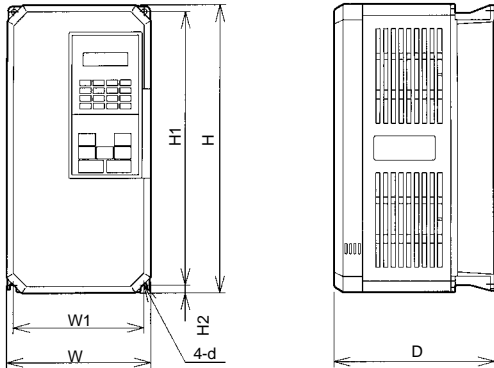

3G3HV-B2□□□□/B4□□□□-E (160 kW max. for B4 models)

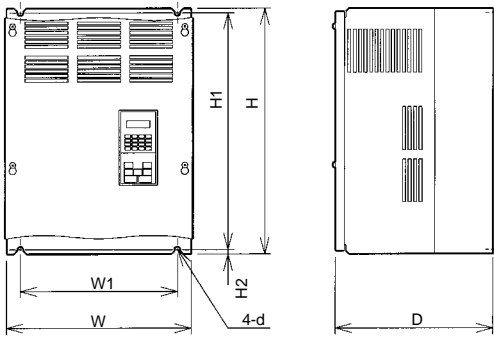

3G3HV-B4□□□□-E (185 kW min.)

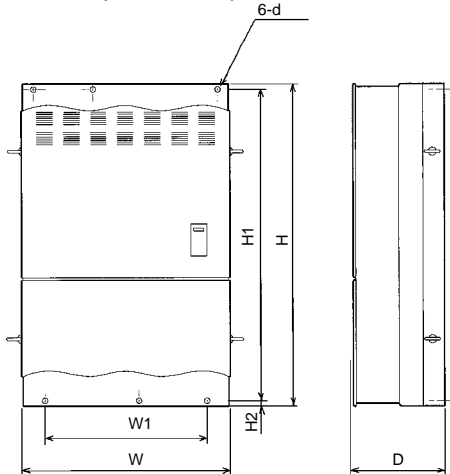

Model 3G3HV-	Maximum applied motor capacity (kW)	Dimensions (mm)						Mount- ing screws d	Weight (kg)
		W	H	D	W1	H1	H2		
A2037-E	3.7	140	280	180	126	266	7.0	M5	Approx. 4.5
A2055-E	5.5	200	300	205	186	285	8.0	M6	Approx. 6
A2075-E	7.5								
A2110-E	11	250	380	225	236	365	7.5	M6	Approx. 11
A2150-E	15								
B2185-E	18.5	325	450	285	275	435	7.5	M6	Approx. 28
B2220-E	22								
B2300-E	30	425	675	350	320	650	12.5	M10	Approx. 61
B2370-E	37								Approx. 62
B2450-E	45	475	800	350	370	775	12.5	M10	Approx. 80
B2550-E	55								Approx. 135
B2750-E	75	575	925	400	445	895	15	M12	Approx. 135
A4037-E	3.7	140	280	180	126	266	7.0	M5	Approx. 4.5
A4055-E	5.5	200	300	205	186	285	8.0	M6	Approx. 6
A4075-E	7.5								
A4110-E	11	250	380	225	236	365	7.5	M6	Approx. 11
A4150-E	15								
B4185-E	18.5	325	450	285	275	435	7.5	M6	Approx. 27
B4220-E	22								
B4300-E	30	325	625	285	275	610	7.5	M6	Approx. 44
B4370-E	37								
B4450-E	45								
B4550-E	55	455	820	350	350	795	12.5	M10	Approx. 79
B4750-E	75								Approx. 80
B411K-E	110	575	925	375	445	895	15	M12	Approx. 135
B416K-E	160			400					Approx. 145
B418K-E	185	950	1450	435	750	1400	25	M12	Approx. 360
B422K-E	220								
B430K-E	300	960	1600	455	750	1550	25	M12	Approx. 420

Wiring

■ Wiring Diagram

For Inverter Models of 200- to 400-V Class with 3.7- to 15-kW Output

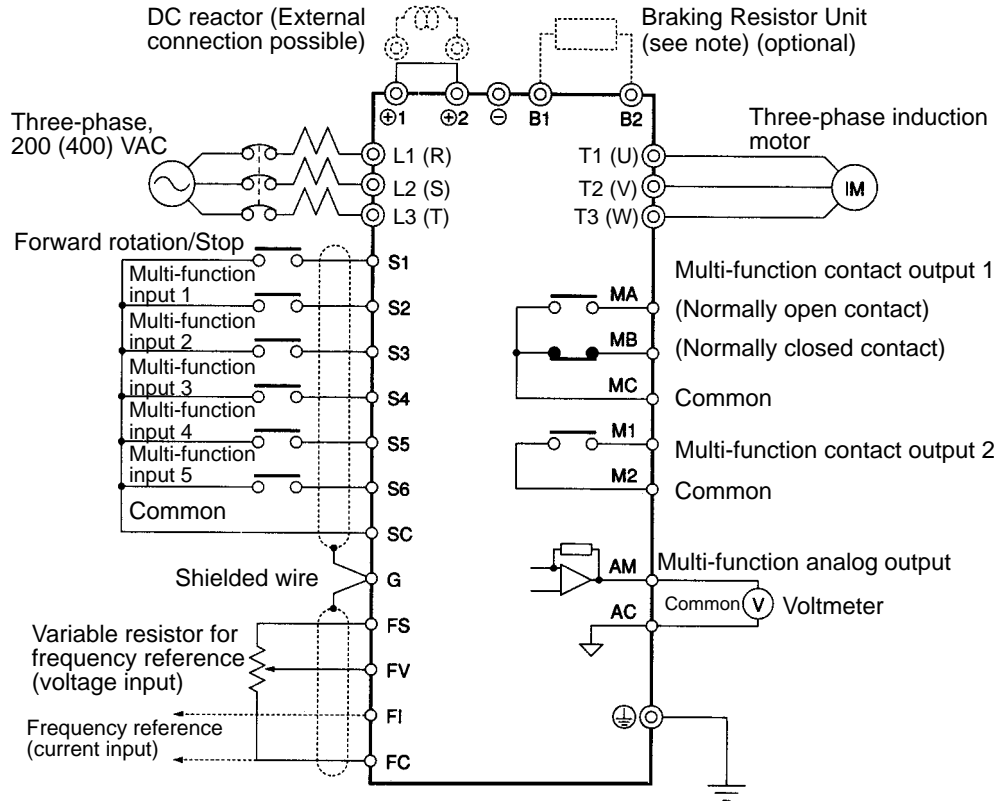

Note: These terminals of the 3G3HV-A2110 and 3G3HV-A2150 connect to the Braking Unit and Braking Resistor Unit.

Dimensions/Wiring

For Inverter Models of 200- to 400-V Class with 18.5- to 300-kW Output

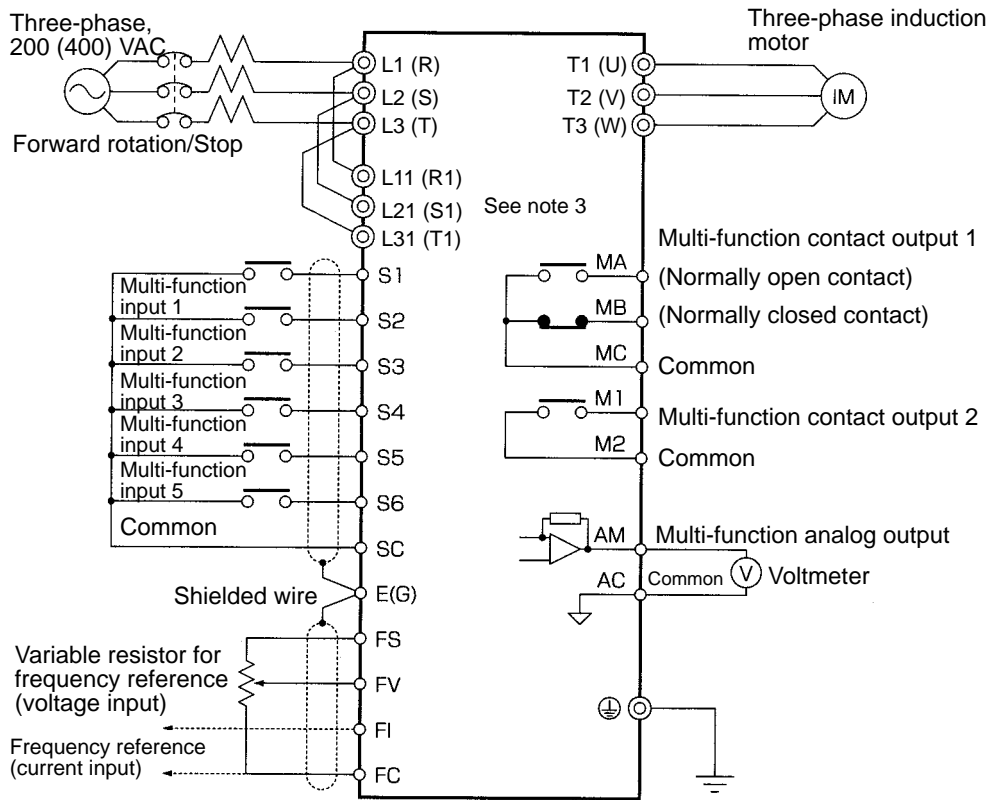

- Note 1.** The Braking Unit or Braking Resistor Unit cannot be connected to the Inverter (18.5 kW to 160 kW). However, 185-kW to 300-kW models can be connected.
- Note 2.** Make sure that terminals R and R1, S and S1, and T and T1 are short-circuited. These terminals are short-circuited with short bars before shipping. Be sure to remove the short bars, however, when using 12-pulse rectification.
- Note 3.** Terminals L11 (R1), L21 (S1), and L31 (T1) are not available on the 185- to 300-kW Inverters.
- Note 4.** The 185- to 300-kW Inverters do not have built-in DC reactors, nor can DC reactors be externally connected.

Standard Models

■ Standard Models

Voltage class	Protective structure	Maximum applied motor capacity	Model		
200-V class	Enclosed wall-mounted type	3.7 kW	3G3HV-A2037-E		
		5.5 kW	3G3HV-A2055-E		
		7.5 kW	3G3HV-A2075-E		
		11 kW	3G3HV-A2110-E		
		15 kW	3G3HV-A2150-E		
	Open-chassis type	18.5 kW	3G3HV-B2185-E		
		22 kW	3G3HV-B2220-E		
		30 kW	3G3HV-B2300-E		
		37 kW	3G3HV-B2370-E		
		45 kW	3G3HV-B2450-E		
		55 kW	3G3HV-B2550-E		
		75 kW	3G3HV-B2750-E		
		400-V class	Enclosed wall-mounted type	3.7 kW	3G3HV-A4037-E
				5.5 kW	3G3HV-A4055-E
7.5 kW	3G3HV-A4075-E				
11 kW	3G3HV-A4110-E				
15 kW	3G3HV-A4150-E				
Open-chassis type	18.5 kW		3G3HV-B4185-E		
	22 kW		3G3HV-B4220-E		
	30 kW		3G3HV-B4300-E		
	37 kW		3G3HV-B4370-E		
	45 kW		3G3HV-B4450-E		
	55 kW		3G3HV-B4550-E		
	75 kW		3G3HV-B4750-E		
	110 kW		3G3HV-B411K-E		
	160 kW		3G3HV-B416K-E		
185 kW	3G3HV-B418K-E				
220 kW	3G3HV-B422K-E				
300 kW	3G3HV-B430K-E				

Standard Models

■ Model Numbers

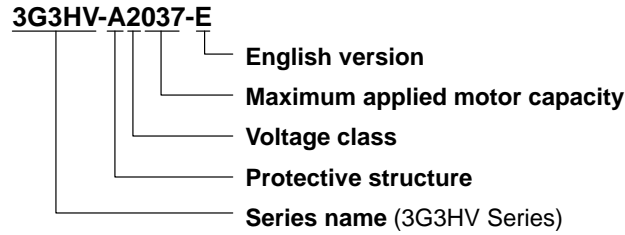

Maximum Applied Motor Capacity

037	3.7 kW
055	5.5 kW
075	7.5 kW
110	11 kW
150	15 kW
185	18.5 kW
220	22 kW
300	30 kW
370	37 kW
450	45 kW
550	55 kW
750	75 kW
11K	110 kW
16K	160 kW
18K	185 kW
22K	220 kW
30K	300 kW

Voltage Class

2	3-phase, 200 VAC (200-V class)
4	3-phase, 400 VAC (400-V class)

Protective Structure

A	Enclosed wall-mounted type
B	Open-chassis type