

SYSDRIVE
3G3SV INVERTER

3G3SV-B2__-E

3G3SV-BB__-E

Operation Manual

I003-E1-1B

Notice:

OMRON products are manufactured for use according to proper procedures by a qualified operator and only for the purposes described in this manual.

The following conventions are used to indicate and classify warnings in this manual. Always heed the information provided with them.

Caution Indicates information that, if not heeded, could result in minor injury or damage to the product.

DANGER! Indicates information that, if not heeded, could result in loss of life or serious injury.

Visual Aids

The following headings appear in the left column of the manual to help you locate different types of information.

Note Indicates information of particular interest for efficient and convenient operation of the product.

1, 2, 3... 1. Indicates lists of one sort or another, such as procedures, checklists, etc.

© OMRON, 1992

All rights reserved. No part of this publication may be reproduced, stored in a retrieval system, or transmitted, in any form, or by any means, mechanical, electronic, photocopying, recording, or otherwise, without the prior written permission of OMRON.

No patent liability is assumed with respect to the use of the information contained herein. Moreover, because OMRON is constantly striving to improve its high-quality products, the information contained in this manual is subject to change without notice. Every precaution has been taken in the preparation of this manual. Nevertheless, OMRON assumes no responsibility for errors or omissions. Neither is any liability assumed for damages resulting from the use of the information contained in this publication.

TABLE OF CONTENTS

SECTION 1

Inverter SYSDRIVE 3G3SV Main Unit	1
1-1 Parts Names of the 3G3SV	2
1-2 Receiving	2
1-3 Installation	3
1-4 Wiring	4
1-5 Operation	8
1-6 Maintenance	11
1-7 Fault Display and Troubleshooting	12
1-8 Specifications	15

SECTION 2

Digital Operator (3G3IV-PJVOP100)	25
2-1 Installation	26
2-2 Description of Digital Operator Display and Operating Sections	28
2-3 Outline of Functions	29
2-4 Function/Constant Setting	29
2-5 Digital Operator Operation Example	32
2-6 Constant Initialization and Write-in Prohibit	34
2-7 Corrective Function	34
2-8 Monitor	36
2-9 Function/Constant List	38
2-10 Description of Functions and Constants	43
2-11 Protection Function	57
2-12 Warning and Self-diagnosis Functions	59
Revision History	61

About this Manual:

This manual provides operating procedures and parameter specifications for the SYSDRIVE 3G3SV Book-Size All-Digital Low-Noise Inverter.

Section 1 describes handling, wiring, operation, maintenance/inspections, troubleshooting and specifications of the SYSDRIVE 3G3SV series (hereinafter called 3G3SV).

Section 2 outlines the digital operator (optional) performance, constants, operation, etc.

Before using the 3G3SV, a thorough understanding of this manual is recommended.

This manual will be of great help for daily maintenance, inspection and troubleshooting.

<p>WARNING Failure to read and understand the information provided in this manual may result in personal injury or death, damage to the product, or product failure. Please read each section in its entirety and be sure you understand the information provided in the section and related sections before attempting any of the procedures or operations given.</p>

SECTION 1

Inverter SYSDRIVE 3G3SV Main Unit

1-1	Parts Names of the 3G3SV	2
1-2	Receiving	2
1-3	Installation	3
1-3-1	Location	3
1-3-2	Mounting Space	4
1-4	Wiring	4
1-4-1	Main Circuit	4
1-4-2	Control Circuit Wiring	6
1-5	Operation	8
1-5-1	Checking before Operation	8
1-5-2	Operation Method	8
1-5-3	Setting before Operation	9
1-5-4	Checking Points at Test Run	10
1-6	Maintenance	11
1-7	Fault Display and Troubleshooting	12
1-7-1	Checking of Causes	12
1-7-2	Alarm Display and Self-diagnosis	13
1-7-3	Inverter Monitor Display	14
1-7-4	Corrective Action for Motor Faults	14
1-8	Specifications	15
1-8-1	Specifications	15
1-8-2	Connection Diagram	18
1-8-3	Terminals	19
1-8-4	Dimensions in Inches (mm)	21
1-8-5	Optional Units	23
1-8-6	Peripheral Units	23

Inverter Model Numbers

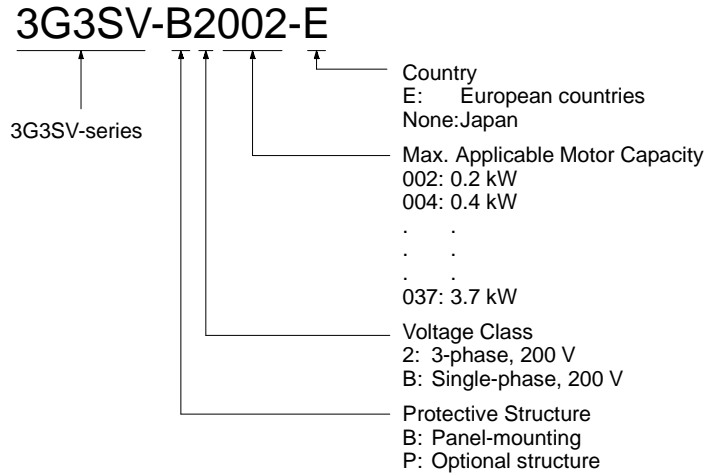

Warning

- 1, 2, 3...**
1. After turning off the main circuit power supply, do not touch circuit components until the “CHARGE” lamp is extinguished. The capacitors are still charged and can be quite dangerous.
 2. Do not change the wiring while power is applied to the circuit.
 3. Do not check signals during operation.
 4. Be sure to ground 3G3SV using the ground terminal G (E).
 5. Never connect main circuit output terminals, T1 (U), T2 (V), T3 (W), to AC main circuit supply.

Caution

- 1, 2, 3...**
1. All the potentiometers of 3G3SV have been adjusted at the factory. Do not change their settings unnecessarily.
 2. Do not perform withstand voltage test on any part of the 3G3SV unit. This electronic equipment uses semi-conductors and is vulnerable to high voltage.

1-3 Installation

1-3-1 Location

Location of the equipment is important to achieve proper performance and normal operating life.

The 3G3SV units should be installed in areas where the following conditions exist.

Ambient temperature: +14% to 113°F, -10% to +50°C.

Protected from rain or moisture.

Protected from direct sunlight.

Protected from corrosive gases or liquids.

Free from airborne dust or metallic particles.

Free from vibration.

Free from magnetic noise.

Caution To house multiple SYSDRIVE 3G3SVs in a switchgear, install a cooling fan or some other means to cool the air entering the inverter below 113°F (45°C).

1-3-2 Mounting Space

Install the 3G3SV vertically and allow sufficient space for effective cooling as shown in Fig. 1.

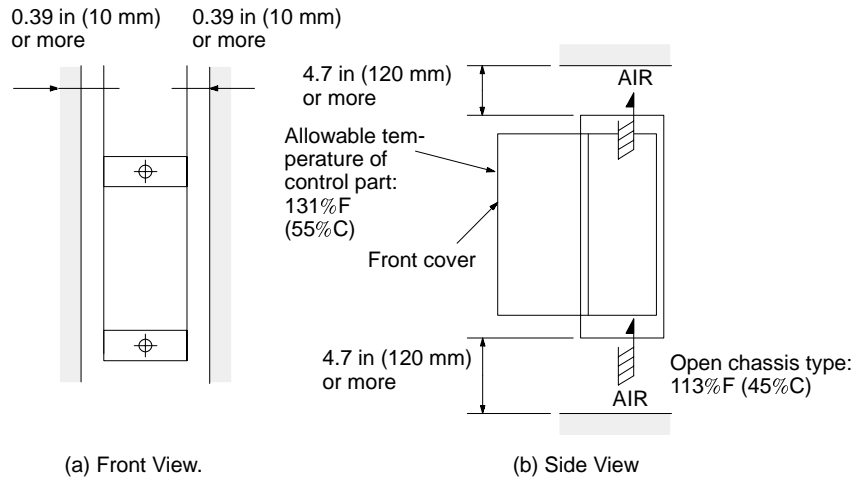

Fig. 1 Mounting Space

1-4 Wiring

1-4-1 Main Circuit

Main Circuit Wiring

Connect wiring as shown in Fig. 2.

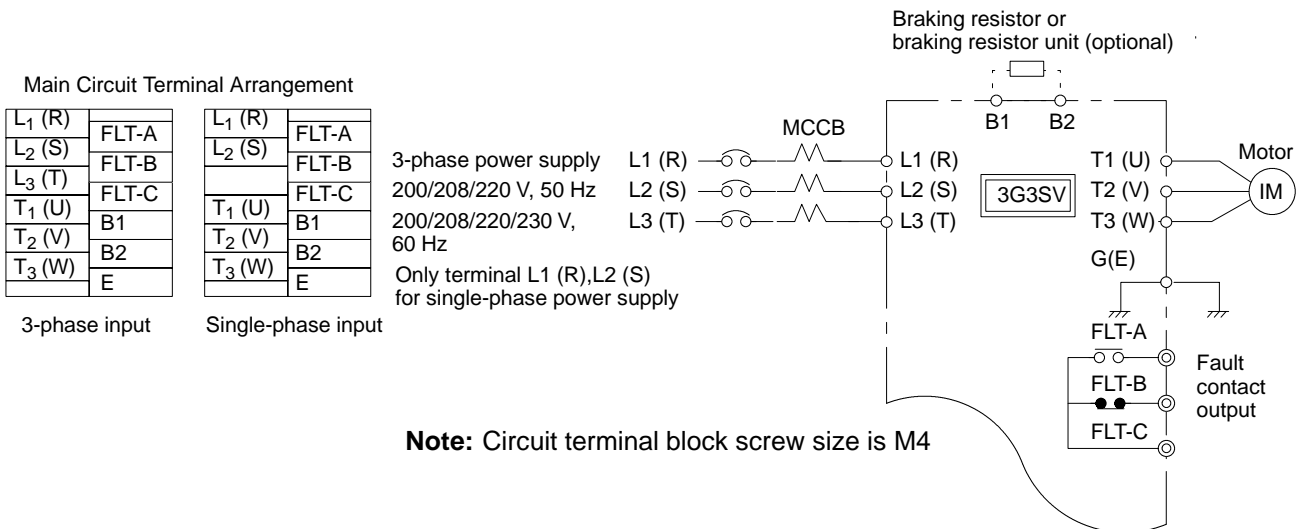

Fig. 2 Main Circuit Wiring

Molded-case Circuit Breaker (MCCB)

Be sure to connect MCCBs between the power supply and 3G3SV input terminals L1 (R), L2 (S), L3 (T). Recommended MCCBs are listed in Table 1.

When a ground fault interrupter is used select the one with no influence for high frequency, and setting current should be 200 mA or over and operating time, 0.1 sec or over to prevent malfunction.

Table 1 Molded-case Circuit Breakers and Magnetic Contactors

3G3SV	Model 3G3SV-____-E		B2002	B2004	B2007	B2015	B2022	B2037
			BB002	BB004	BB007	BB015	BB022	BB037
	Capacity		0.7 kVA	1.3 kVA	2.2 kVA	2.8 kVA	4.7 kVA	7.5 kVA
	Rated output current		1.5 A	3 A	5 A	6.5 A	11 A	17.5 A
Molded-case Circuit Breaker	Rated current	3-phase	5A	5A	10A	20A	20A	30A
		Single-phase	5A	10A	20A	20A	40A	50A

Surge Absorber

The surge absorbers should be connected to the coils of relays, magnetic contactors, magnetic valves, or magnetic relays. Select the type from Table 2.

Table 2 Surge Absorbers

Coils of magnetic contactor and control relay		Surge absorber (see note)	
		Model	Specifications
200 to 230 V	Large-size magnetic contactors	DCR2-50A22E	250 VAC, 0.5 mF + 20 W
	Control relay LY-2, -3 (OMRON) MM-2, -4 (OMRON)	DCR2-10A25C	250 VAC, 0.1 mF + 100 W
400 to 460 V units		DCR2-50D100B	1,000 VDC, 0.5 mF + 220 W

Note Made by MARCON Electronics. Marketed in Japan.

Wiring

Main Circuit Input/Output

- 1, 2, 3...** 1. Phase rotation of input terminals L1 (R), L2 (S), L3 (T) is available in either direction, clockwise and counterclockwise.
2. When inverter output terminals T1 (U), T2 (V), and T3 (W) are connected to motor terminals T1 (U), T2 (V), and T3 (W), respectively, motor rotates counterclockwise, viewed from opposite drive end, upon forward operation command. To reverse the rotation interchange any two of motor leads.
3. Never connect AC main circuit power supply to output terminals T1 (U), T2 (V), and T3 (W).
4. Care should be taken to prevent contact of wiring leads with the 3G3SV cabinet, or a short-circuit may result.
5. Never connect power factor correction capacitor or noise filter to 3G3SV output.
6. Never open or close contactors in the output circuit unless inverter is properly sized.

Wire Size

Table 3 shows wire sizes and types.

Model 3G3SV	Inverter capacity	Terminal symbol	Terminal screw	Wire size	AWG	Wire type
B2002	0.7 KVA	L1 (R), L2 (S), L3 (T), B1 B2 T1 (U), T2 (V), T3 (W)	M4	2-5.5 mm ²	14-10	Power cable: 600 V vinyl sheathed lead or equivalent
BB002		G (E)				
B2004	1.3 KVA	L1 (R), L2 (S), L3 (T), B1 B2 T1 (U), T2 (V), T3 (W)	M4	2-5.5 mm ²	14-10	
BB004		G (E)				
B2007	2.2 KVA	L1 (R), L2 (S), L3 (T), B1 B2 T1 (U), T2 (V), T3 (W)	M4	2-5.5 mm ²	14-10	
BB007		G (E)				
B2015	2.8 KVA	L1 (R), L2 (S), L3 (T), B1 B2 T1 (U), T2 (V), T3 (W)	M4	3.5-5.5 mm ²	12-10	
BB015		G (E)		2-5.5 mm ²	14-10	
B2022	4.7 KVA	L1 (R), L2 (S), L3 (T), B1 B2 T1 (U), T2 (V), T3 (W)	M5	3-5.8 mm ²	12-10	
BB022		G (E)		2-8 mm ²	14-10	
B2037	7.5 KVA	L1 (R), L2 (S), L3 (T), B1 B2 T1 (U), T2 (V), T3 (W)	M5	3-5.8 mm ²	12-10	
BB037		G (E)		2-8 mm ²	14-10	

Important

Lead size should be determined considering voltage drop of leads.

Grounding

Ground the casing of the 3G3SV using ground terminal G (E).

- 1, 2, 3...**
1. Ground resistance should be 100 W or less.
 2. Never ground the 3G3SV in common with welding machines, motors, and other large-current electrical equipment, or ground pole. Run the ground lead in a separate conduit from leads for large-current electrical equipment.
 3. Use the ground leads which comply with AWG standards and make the length as short as possible.
 4. Where several 3G3SV units are used side by side, all the units should preferably be grounded directly to the ground poles. However, connecting all the ground terminals of 3G3SV in parallel, and grounding only one of 3G3SV to the ground pole is also permissible (Fig. 4). However, do not form a loop with the ground leads.

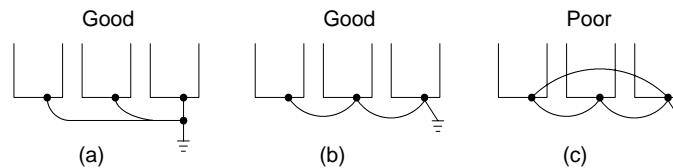

Fig. 3 Grounding of Three 3G3SV Units

1-4-2 Control Circuit Wiring

Control Signal

Fig. 4 shows the relationship between I/O signals and screw terminal numbers.

- Note**
1. Separate the control signal wiring from power lines.
 2. Use shielded leads or twisted-pair shielded leads for freq. setting signal (analog) and ensure sufficient terminal processing.

Control Circuit Terminal Arrangement

1	14
2	8
3	15
4	9
5	16
6	10
7	17
	11
	18
	12
	19
	13
	20

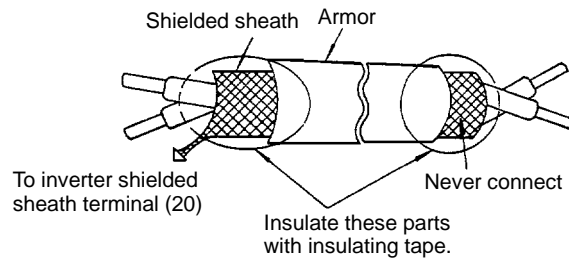
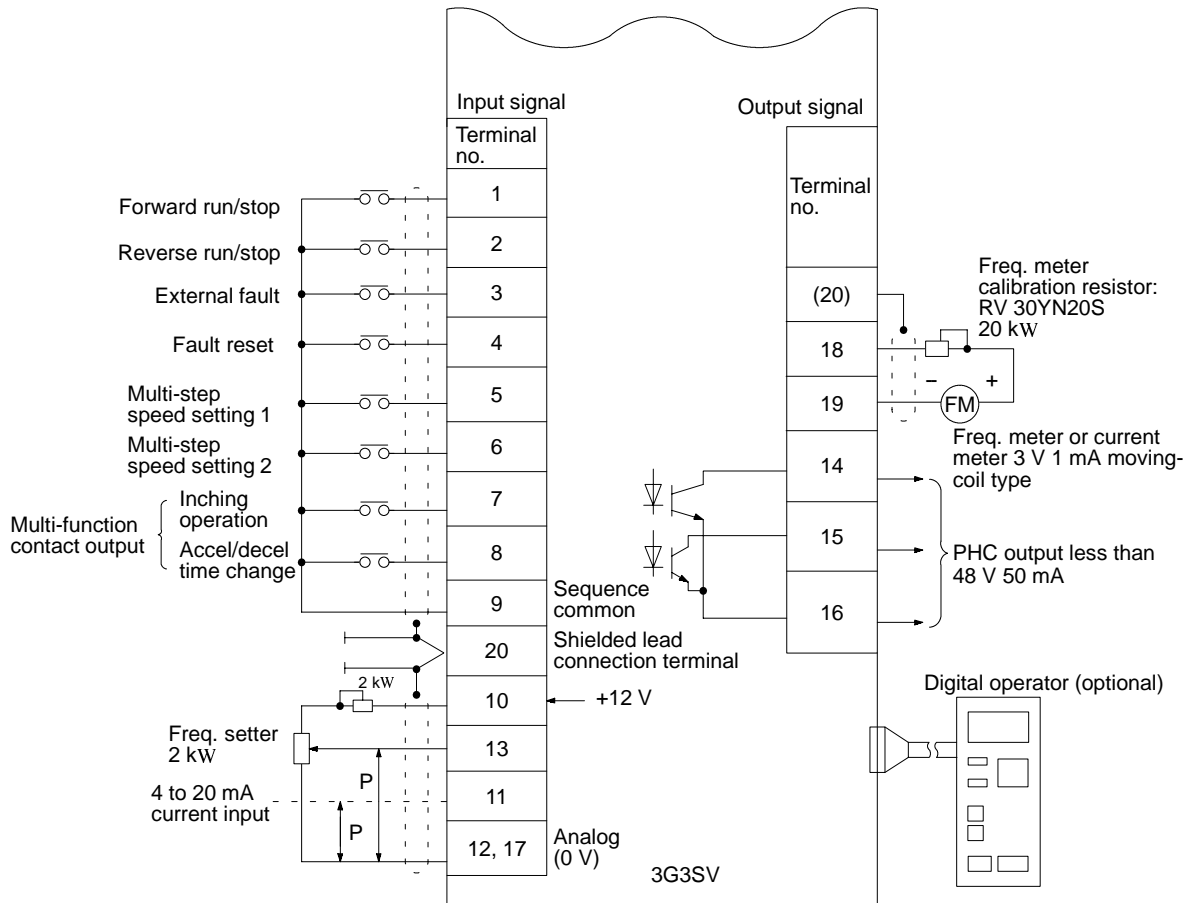

Fig. 4 Shielded Lead Termination

1-5 Operation

1-5-1 Checking before Operation

Check the following items after completion of installation and wiring:

- 1, 2, 3...**
1. No fault in wiring. Especially, the power supply is connected to the output terminals T1 (U), T2 (V), and T3 (W).
 2. No short-circuit because of wiring contamination (dust, oil, etc.).
 3. Screws and terminals are not loosened. Wiring is provided properly.
 4. Load status is good.

For safe operation, before operation, the motor must be able to operate alone by separating it from the coupling or belt which connects the motor and machine.

When the motor is operated with the machine directly connected, pay close attention.

1-5-2 Operation Method

The inverter can be operated in the following two methods.

Operation by External Terminal Input

The inverter is operated by frequency setter, operation switches, etc. connected to the external terminals.

Prior to shipping, the initial setting mode is "operation by external terminal". After completion of external terminal wiring, operation can be started. Therefore, even without the digital operator, operation can be performed.

Each set value such as accel/decel time is set to a value indicated in page 46 at the factory. To change this value, the digital operator must be connected.

The following will be available by connecting the digital operator when the inverter is operated by external terminal:

- Monitoring of output frequency and output current
- Reading and changing of each constant set value
- Checking of the contents at fault occurrence
- Checking of the operation status (FWD/REV run)

Output frequency or output current is displayed in the digital display section.

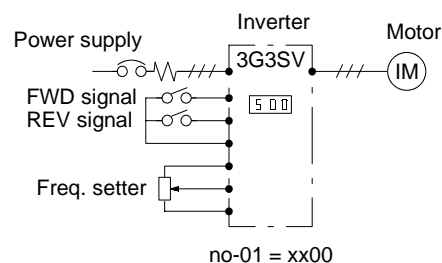

Operation by Digital Operator

The inverter is operated only by the digital operator, by operating the digital operator RUN (run command) key, etc.

Operation is possible by changing the operation mode to “operation by digital operator” mode (no-01 = 0011).

Even if the frequency setter or operation switch is not connected, operation can be easily performed.

Refer to page 29 for the details of the operation method.

The digital operator is optional which must be ordered separately.

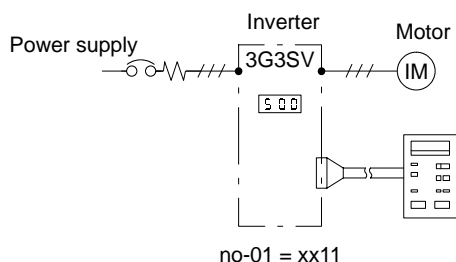

1-5-3 Setting before Operation

Since the standard inverter models are not provided with constant setting switches, etc., the digital operator must be used on order to change the constants from the initial values to the values in accordance with the load specifications.

Set Value Prior to Shipping

The values indicated in page 46 are set prior to shipping. Change the set values by using the digital operator only to find the optimum values.

The following describes the functions and initial constant set values which are often used for operation.

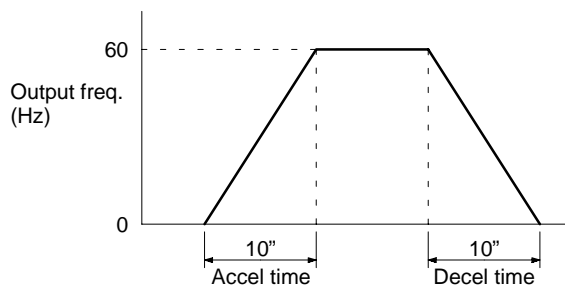

Fig. 5 Output Frequency and Accel/Decel Time

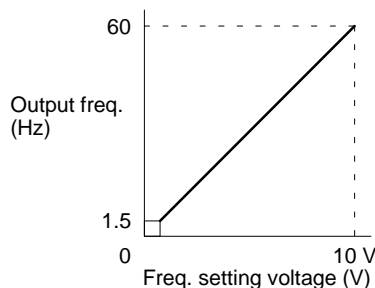

Fig. 6 Frequency Setting Signal and Output Frequency

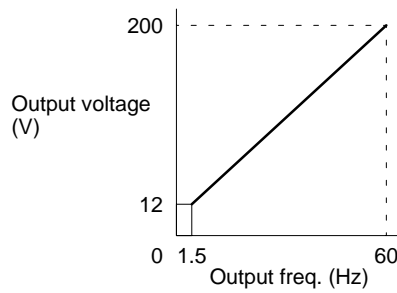

Fig. 7 V/f Characteristics

Motor Rated Current Setting

Since the inverter is provided with electronic thermal overload protective function in order to protect the motor from overheating faults, set the rated current value described on the motor nameplate. Standard 4-pole motor current value is set as the initial value.

Note Provide a thermal relay or thermal protector when more than one motor is operated simultaneously.

1-5-4 Checking Points at Test Run

Turn on the power supply after checking that the FWD (or REV) run signal has been turned off.

Perform the test run as described below and check the operation status.

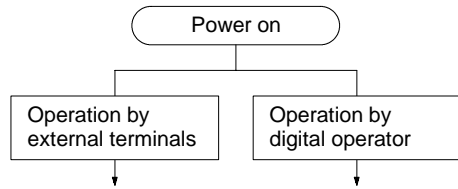

Note Refer to Section 2-2 *Description of Digital Operator and Operating Sections* for the details of the operation contents.

Operation method selection	“Operation by external terminal” mode is set prior to shipping.	Enter the program mode (depress <input type="button" value="PRG"/> key) and set No. 01 data to 0011 by using <input type="button" value="▲"/> or <input type="button" value="▼"/> keys. Then depress <input type="button" value="ENT"/> key.
Operation	Turn off FWD or REV run signal. Turn the frequency setter knob slowly to the right to increase the value fully.	Enter the drive mode (depress <input type="button" value="DRIVE"/> key.) After setting frequency set value required for operation by using <input type="button" value="▲"/> or <input type="button" value="▼"/> keys, depress <input type="button" value="ENT"/> key. Depress <input type="button" value="RUN"/> key.
Stopping	Turn the frequency setter knob slowly to the left to decrease value fully.	Depress <input type="button" value="STOP"/> key. (see note)

Note When output frequency reaches 1.5 Hz, dynamic brake (DB) is applied for 0.5 s and the motor stops immediately.

Check Points

- 1, 2, 3...**
1. Motor rotation is smooth.
 2. Motor rotating direction is proper.

3. Motor does not have abnormal vibration or beat.
4. Accel/decel is smooth.

Precautions

- 1, 2, 3... 1. The motor does not start up if both FWD and REV run signals are turned on simultaneously. If they are turned on simultaneously during run, the motor decelerates to a stop.
2. When output frequency reaches 1.5 Hz (set value prior to shipping) at deceleration, the dynamic brake (DB) operates for 0.5 s and metallic noise is generated by the motor. However, this noise is normal.
3. If a fault occurs during acceleration or deceleration and the motor coasts to a stop, check the motor stopping position and then the following items:
 - a) Load is not excessively large.
 - b) Accel/decel time is long enough for load.

Resetting must be performed by external signal input (or **RESET** key of the digital operator) or by turning off the power supply.

1-6 Maintenance

Periodic Inspection

The 3G3SV requires very few routine checks. It will function longer if it is kept clean, cool and dry, while observing the precautions listed in "Location". Check for tightness of electrical connections, discoloration or other signs of overheating. Use Table 6 as the inspection guide. Before servicing, turn off AC main circuit power and be sure that CHARGE lamp is off.

Table 6 Periodic Inspection

Component	Check	Corrective action
External terminals, unit mounting bolts, connectors, etc.	Loosened screws	Tighten
	Loosened connectors	Tighten
Cooling fins	Build-up of dust and dirt	Blow with dry compressed air of 57 to 85 lbs. in ² (4 to 6 kg \$ cm ²) pressure.
Printed circuit board	Accumulation of conductive dust or oil mist.	Clean the board. If dust and oil cannot be removed, replace the inverter unit.
Cooling fan	For abnormal noise and vibration. Whether the cumulative operation time exceeds 20,000 hours or not.	Replace the cooling fan.
Power elements	Accumulation of dust and dirt	Blow with a dry compressed air of 57 to 85 lbs. in ² (4 to 6 kg \$ cm ²) pressure.
Smoothing capacitor	Discoloration or odor	Replace the capacitor or inverter unit.

1-7 Fault Display and Troubleshooting

If a fault occurs and the inverter functions are lit, check for the causes and provide proper corrective actions, referring to the following checking method.

1-7-1 Checking of Causes

The inverter has protective functions to protect it from faults such as overcurrent or overvoltage. If a fault occurs, the protective functions operate to shut off the inverter output and the motor coasts to a stop. At the same time, the fault contact signal is output.

When the protective functions operate, the digital display unit displays the fault shown in Table 5. Also when the digital operator is used, the same display except for control function faults is provided. (Refer to note 1 following Table 5.)

Operation can be restarted by turning on the reset input signal or turning off the power supply once.

Table 5 Fault Display and Contents

Fault display	Contents	Possible cause/corrective actions
OC (Overcurrent) %c	Inverter output current exceeds 200% of rated current. (Momentary action)	The following causes can be considered: inverter output side short-circuit, excessive load GD ² , excessively short setting of accel/ decel time, special motor use, motor start during coasting, start of motor with larger capacity than inverter, inverter output side magnetic contactor on/off. Reset after finding the cause.
GF (Ground Fault) gf	Inverter output side is grounded.	Check that the motor or load side wiring is not grounded.
OV (Overvoltage) %U	Main circuit DC voltage exceeds 410 V or more because of excessive regenerative energy from motor.	Decel time setting is not sufficient or minus load (elevators, etc.) is decreasing. Increase decel time or connect a braking resistor (option).
UV (Undervoltage) uU1	Undervoltage status is entered. (or main circuit DC voltage becomes 210 V or less, or less than undervoltage detection level.)	Input power supply voltage is reduced, phases are opened or momentary power loss occurs, etc. Check the power supply voltage, or check that main circuit power supply wiring is connected properly or terminal screws are tightened well.
OH (Inverter Overheat) %h	Thermistor operates because of inverter overload operation or ambient temperature rise.	Load is too large, V/f characteristics are not proper, setting time is too short or ambient temperature exceeds 45°C, etc. Correct load size, V/f set value or ambient temperature.
(No display) (Fuse Blown)	Main circuit fuse is blown.	Replace the inverter.
OL1 (Motor Overload) %I1	Motor overload protection operates because of electronic overload thermal.	Correct load size, operation pattern or V/f set value. Set the rated current value described in the motor nameplate.

Fault display	Contents	Possible cause/corrective actions
OL2 (Inverter Overload) %12	Inverter overload protection operates because of electronic overload thermal.	Correct load size, operation pattern or V/f set value. Recheck the inverter capacity.
OL3 (Overtorque Detection) %13	Motor current exceeding set value is applied because of machine fault or overload.	Check the machine using status and remove the cause. Or increase the set value up to the allowable value.
EF3 (External Fault) ef3	Inverter accepts fault contact signal input from external circuit.	Check the external circuitry (sequence).
CPF (Control Function Fault) cpf-__,f__ (see note 1)	Inverter control functions are broken down.	Turn off the power supply once and then turn it on again. If the fault still exists, replace the inverter.
CPF-00 cpf00 (f00)	Initial memory fault is detected.	Turn off the power supply once and turn it on again. If the fault still exists, replace the inverter.
CPF-01 cpf01 (f01)	Transmission error or ROM fault is detected.	Turn off the power supply once and turn it on again. If the fault still exists, replace the inverter.
CPF-04 cpf04 (f04)	Constant fault is detected.	Record all data, and then make initialization. Turn off the supply once and turn it on again. If the fault still exists, replace the inverter.
CPF-05 cpf05 (f05)	AD converter fault is detected.	Turn off the power supply once and turn it on again. If the fault still exists, replace the inverter.
CPF-07 cpf07 (f07)	Thermistor fault is detected.	Replace the inverter.

- Note**
1. Digital operator display contents
 2. Details of cpf-__ display. Display in () belongs to the digital display section.

1-7-2 Alarm Display and Self-diagnosis

Fault display	Contents	Possible cause/corrective actions
EF (Simultaneous Input of FWD and REV commands) ef blinks.	Both FWD and REV commands are "closed" for 500 ms or more.	Check the sequence circuit
BB (External Baseblock) bb	External baseblock signal is accepted. (Pay attention since operation restarts by releasing the external baseblock signal.)	Check the sequence circuit
UV (Main Circuit Under-voltage) uU blinks.	Main circuit DC voltage is reduced less than detection level when inverter is not outputting.	Check power supply voltage or check that power supply terminal screws are tightened well.
OL3 (Overtorque Detection) %13 blinks.	Inverter output current exceeds overtorque detection level.	Check the machine using status and remove the cause. Or increase the set value.

1-7-3 Inverter Monitor Display

The inverter display unit (3-digit LED) provided for the standard models has the following display, disregarding the modes (drive mode, program mode).

Display contents can be selected by the 1st digit of constant 21 monitor selection.

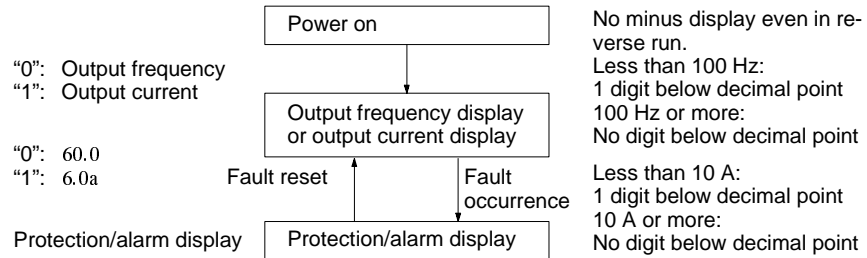

1-7-4 Corrective Action for Motor Faults

Table 6 shows the check points and corrective actions of motor faults.

Table 6 Motor Faults and Corrective Actions

Fault	Check point	Corrective action
Motor does not rotate.	Power supply voltage is applied to power supply terminals L1 (R), L2 (S), and L3 (T). (Check that charge lamp is on.)	Turn on the power supply. Turn off the power supply and then on again. Check power supply voltage.
	Voltage is output to output terminals T1 (U), T2 (V), and T3 (W).	Turn off the power supply and then on again.
	Load is excessively large. (Motor is locked.)	Reduce the load. (Release the lock.)
	Fault is displayed.	Check according to Par. 1.7.1
	FWD or REV run command is entered.	Correct the wiring.
	Frequency setting signal is entered.	
	Operation (method selection) mode setting is proper.	Check the operation method selection mode by using the digital operator.
Motor rotating direction is reversed.	Wiring of output terminals T1 (U), T2 (V), and T3 (W) is correct.	Match them to the phase order of motor T1 (U), T2 (V), and T3 (W).
	Wiring of FWD and REV run signals is correct.	Correct the wiring.
Motor rotates but variable speed is not available.	Wiring of frequency setting circuit is correct.	Correct the wiring.
	Load is not excessively large.	Reduce the load.
Motor r/min is too high (low).	Motor ratings (number of poles, voltage) are proper.	Check the specifications and nameplate.
	Accel/decel ratio by speed changer (gears, etc.) is correct.	---
	Maximum frequency set value is correct.	Check the maximum frequency set value.
	Voltage between motor terminals is not excessively reduced.	Check the base frequency.
r/min is not stable during operation.	Load is not excessively large.	Reduce the load.
	Load variation is not excessively large.	Reduce the load variation. Increase the inverter or motor capacity.

1-8 Specifications

1-8-1 Specifications

Inverter model 3G3SV-____-E	3-phase	B2002	B2004	B2007	B2015	B2022	B2037
	Single-phase	BB002	BB004	BB007	BB015	BB022	BB037
Max. applicable motor output Hp (kW) (see note 1)		0.25 (0.2)	0.5 (0.4)	0.25 (0.75)	2 (1.5)	3 (2.2)	5 (3.7)
Output characteristics	Inverter capacity (kVA)	0.7	1.3	2.2	2.8	4.7	7.5
	Rated output current (A)	1.5	3	5	6.5	11	17.5
	Max. continuous output current (A) (see note 2)	1.7	3.4	5.6	7.3	12.4	19.6
	Max. output voltage	3-phase, 200/208/220/230 V (proportional to input voltage)					
	Max. output frequency	400 Hz (available with constant setting)					

Inverter model 3G3SV-____-E		3-phase	B2002	B2004	B2007	B2015	B2022	B2037
		Single-phase	BB002	BB004	BB007	BB015	BB022	BB037
Power supply	Rated input voltage and frequency	3-phase: 200/208/220 V, 50 Hz 200/208/220/230 V, 60 Hz Single-phase: 200/208/220/240 V, 50 Hz 200/208/220/230 V, 60 Hz						
	Allowable voltage fluctuation	+10%						
	Allowable frequency fluctuation	+5%						
Control characteristics	Control method	Sine wave PWM						
	Frequency control range	0.1 to 400 Hz						
	Frequency accuracy	Digital command: 0.01% +14% to 104%F, -10% to 40%C Analog command: 0.1% 77%+18%F, 25%+10%C						
	Frequency resolution	Digital operator reference: 0.1 Hz. Analog reference: 0.06 Hz/60 Hz						
	Output frequency resolution	0.1 Hz						
	Overload capacity	150% rated output current for one minute						
	Frequency setting signal	0 to 10 VDC (20 kW), 4-20 mA (250 W)						
	Accel/decel time	0.1 to 600 sec (accel/decel time setting independently)						
	Braking torque	Approx. 20% (up to 150% possible with optional braking resistor externally mounted)						
	V/f characteristic	Possible to set any program of V/f pattern						
	Stall prevention level	Possible to set operating current						
	Protective functions	Instantaneous overcurrent	Motor coasts to a stop at approx. 200% rated current.					
Overload		Motor coasts to a stop for 1 minute at 150% rated output current						
Motor overload protection		Electronic thermal overload relay						
Overvoltage		Motor coasts to a stop if converter output voltage exceeds 410 V.						
Undervoltage		Motor coasts to a stop if the converter output voltage of a 3-phase model drops to 210 V or below and that of a single-phase model drops to 170 V or below.						
Ground fault		Provided by electronic circuit.						
Momentary power loss		Immediately stops if 15 ms or more momentary power loss. Resumes operating after a power loss period of approximately 2 s if the input is 1.5 kW or more and approximately 1 s if the input is 0.75 kW or less in a certain mode.						
Heat sink fin overheat		Protected by thermistor						
Power charge indication		Charge lamp stays ON until bus voltage drops below 50 V.						

Inverter model 3G3SV-____-E		3-phase	B2002	B2004	B2007	B2015	B2022	B2037
		Single-phase	BB002	BB004	BB007	BB015	BB022	BB037
Operation conditions	Input signals	Operation signal	Forward operation/reverse operation by individual command					
		External fault	Output stops by external fault input.					
		Reset	Releases protection while the function is operating.					
		Multifunction setting	Possible to set max. 9 speed					
		Multifunction input selection	Multifunction contact input: two of the following signals available to select. Multispeed command 3, jog operation, accel/decel time select, 3 wire sequence, external coasting stop, speed search					
	Output signals	Operation state (photocoupler output)	Multifunction contact output: two of the following signals available to select. During running output, zero speed, frequency agree, output frequency \geq setting value, during overtorque detection					
		Fault contact	NO/NC contact output					
	Built-in function		The following set-up is available: frequency reference bias/gain, upper/lower frequency limit, DC braking stop current at start, s-curve characteristics, torque boost, frequency meter calibrating gain, auto reset/restart operation					
	Monitor display function	7 segments, 3-digits display section	Displays output frequency and contents at protective function operation.					
		Digital operator (optional)	Displays setting frequency, output frequency, output current, rotating direction, and the contents at protective function operation.					
Analog output monitor		Analog output (0 to 10 VDC). Possible to select output frequency or output current.						
Protective configuration		Open chassis						
Cooling method		Self-cooling				Forced cooling		
Weight	lb (kg)	4.4 (2)	4.4 (2)	6.6 (3)	6.6 (3)	13 (6)	13 (6)	
Environmental Conditions	Location		Indoor (protected from corrosive gases and dust)					
	Ambient temperature		+14% to 122°F (-10% to +50°C) (not frozen)					
	Storage temperature (see note 3)		-4% to 140°F (-20% to +60°C)					
	Humidity		90% RH (non-condensing)					
	Vibration		0.6 G					

- Note**
1. Our standard 4-pole motor is used for maximum applicable motor output.
 2. Allowable values for the applications not requiring overload.
 3. Temperature during shipping (for short period).

1-8-2 Connection Diagram

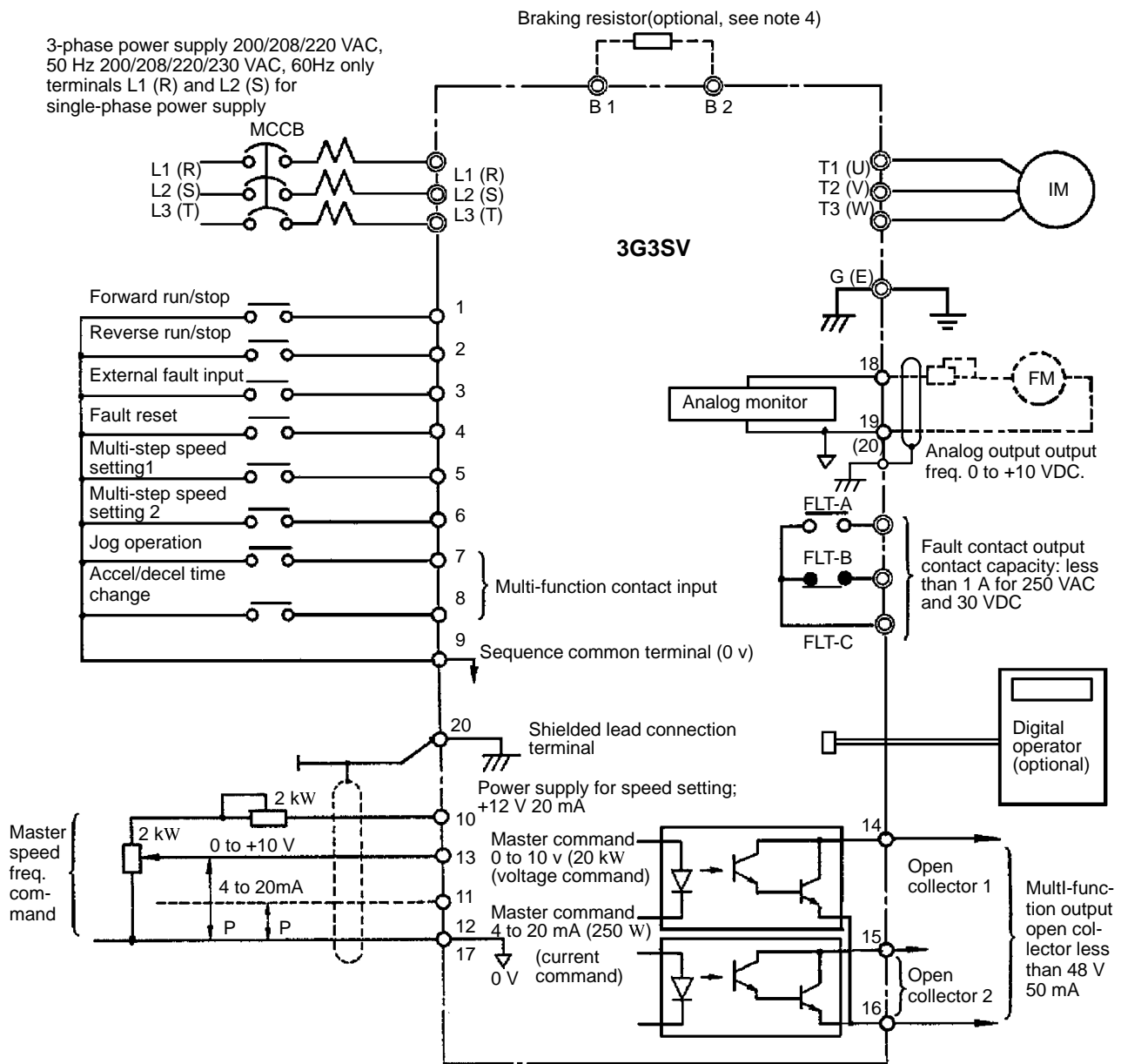

- Note**
1. indicates shielded leads and twisted-pair shielded leads.
 2. External terminal (10) of +12 V has maximum output current capacity of 20 mA.
 3. Terminal symbols: shows main circuit; shows control circuit.
 4. Set overload relay when using braking resistor (type 3G3IV-PERF150WJ). Also, use sequencer to break power supply side on overload relay trip contact when using braking resistor or braking resistor unit.

1-8-3 Terminals

Main Circuit

Terminal	Description
L1 (R)	Main circuit power input "L1", "L2" are used for single-phase input specifications.
L2 (S)	
L3 (T)	
T1 (U)	Inverter output
T2 (V)	
T3 (W)	
B1	Braking unit or braking unit resistor connector
B2	
FLT-A	Contact capacity for fault signal output "Closed" between A and C at fault "Open" between B and C at fault 250 VAC 1 A or less 30 VDC 1 A or less
FLT-B	
FLT-C	
G (E)	Grounding (ground resistance should be 100 W or less)

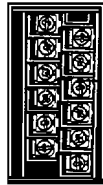

Input	L1 (R)	FLT-A	Fault
	L2 (S)	FLT-B	
	L3 (T)	FLT-C	
Output	T1 (U)	B1	OB resistor
	T2 (V)	B2	
	T3 (W)	E	FG

3-phase

Input	L1 (R)	FLT-A	Fault
	L2 (S)	FLT-B	
		FLT-C	
Output	T1 (U)	B1	OB resistor
	T2 (V)	B2	
	T3 (W)	E	FG

Single-phase

Main Circuit Terminals

Control Circuit

Classification	Terminal	Signal function	Description		Signal level
Sequence input signal	1	Forward operation-stop signal	Forward run at "closed", stop at "open"		Photocoupler insulation input +24 VDC 8 mA
	2	Reverse operation-stop signal	Reverse run at "closed", stop at "open"		
	3	External fault input	Fault at "closed", normal at "open"		
	4	Fault reset input	Reset at "closed"		
	5	Multi-step speed ref. 1	Effective at "closed"		
	6	Multi-step speed ref. 2	Effective at "closed"		
	7	Jog command	Jog run at "closed"	Multifunction contact input: two signals available to select	
	8	Accel/decel time select	Second accel/decel time effective at "closed"		
	9	Sequence control input common terminal	---		
Analog input signal	10	Power supply terminal for speed ref.	Speed ref. power supply		+12 V (allowable current 20 mA max.)
	13	Frequency ref.	0 to +10 V/100% freq.		0 to +10 V (20 kW)
	11		4 to 20 mA/100% freq.		4 to 20 mA (250 W)
	12	Common terminal for control circuit	0 V		---
	17				
	20	Connection to shield sheath of signal lead	---		---
	14	During running	Closed between terminal 14 and 16 during running	Multifunction contact output: two signals available to select	Open collector output +48 V 50 mA or less
	15	Frequency agreed signal	Closed between terminals 15 and 16 when set freq. = output freq. is obtained.		
	16	Open collector output common			
Analog output signal	18	Frequency meter	0 to 10 V/100% Possible to select current meter output.		0 to 11 V max. 2 mA or less
	19	Common			

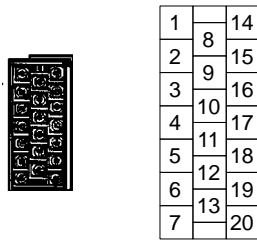

**Control Circuit
Terminals**

1-8-4 Dimensions in Inches (mm)

3G3SV-B2002 to -B2015, 3G3SV-BB002 to -BB015 [0.25 to 2 HP (0.2 to 1.5 kW)]

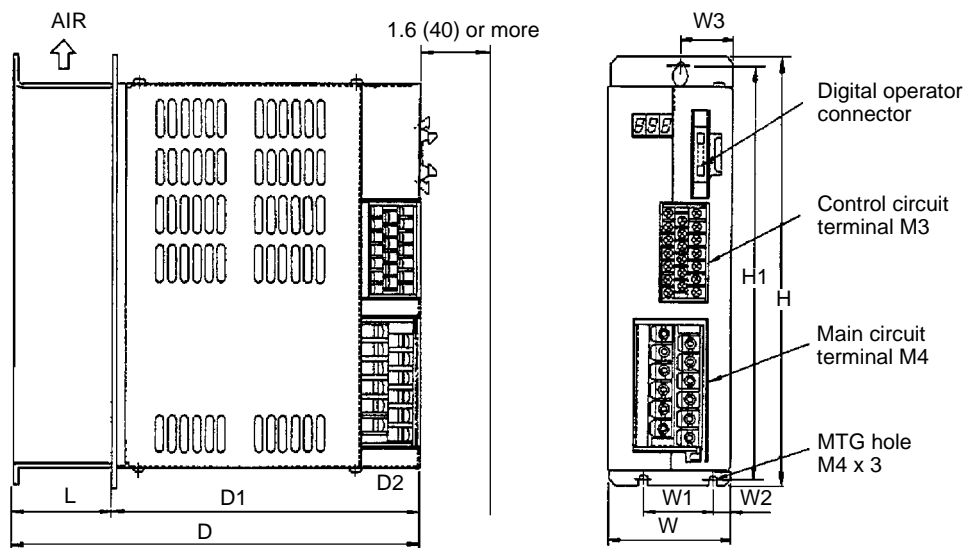

3G3SV-B2022, -B2037, 3G3SV-BB022, BB037 [3/5 HP (2.2/3.7 kW)]

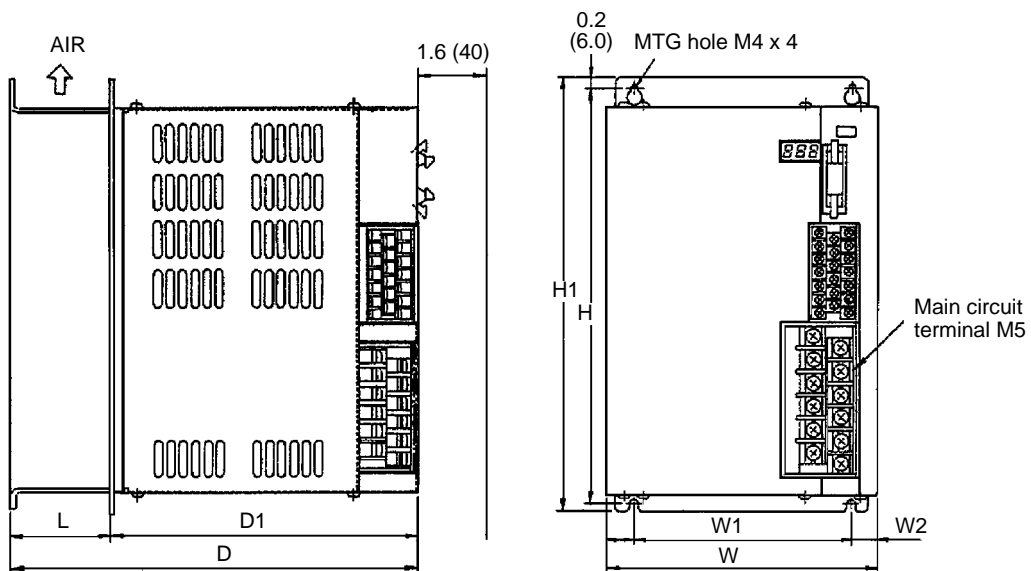

Max. applicable motor output HP (kW)	Dimensions in inches (mm)									
	W	W1	W2	W3	H	H1	D	D1	D2	L
0.25/0.5 (0.2/0.4)	2.8 (70)	1.6 (40)	0.4 (10)	1.2 (30)	9.9 (250)	9.5 (240)	6.9 (174)	6.9 (174)	1.4 (33)	---
1/2 (0.75/1.5)	2.8 (72)	1.6 (40)	0.4 (10)	1.2 (30)	9.9 (250)	9.5 (240)	9.1 (230)	6.6 (167)	1.4 (33)	2.5 (63)
3/5 (2.2/3.7)	5.9 (150)	4.7 (120)	0.6 (15)	---	9.9 (250)	9.5 (240)	9.1 (230)	6.5 (165)	1.4 (33)	2.6 (65)

Panel Drilling Plan for Mounting Cooling Fin Outside the Board

1/2 HP (0.75/1.5 kW) (for Use of Attachment)

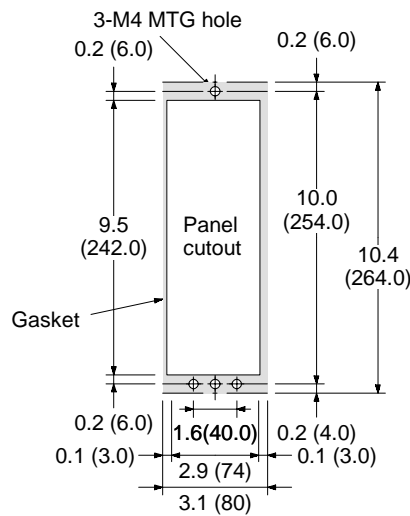

3/5 HP (2.2/3.7 kW)

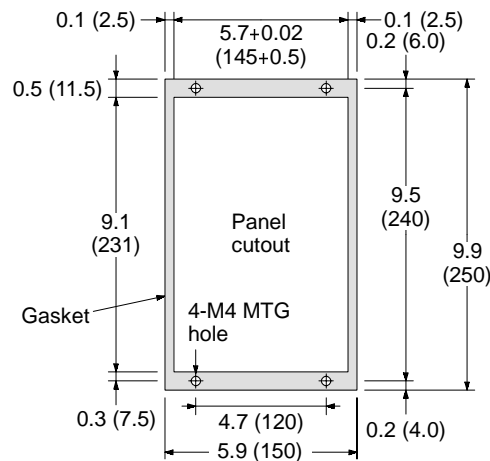

1-8-5 Optional Units

Name	Model (code No.)	Function	Installing position
Digital operator	3G3IV-PJVOP100	Operation sequence, all function selection and constant setting are available. Frequency setting or display of output frequency, output current and fault is also possible	Separately installed
Special extension cable for digital operator	1 m cable (3G3IV-PCN122) 3 m cable (3G3IV-PCN322)	This extension cable is used when the digital operator is used. Length: 1 m or 3 m	---
Braking resistor unit	3G3IV-PLKEB____	Shortens the motor deceleration time by causing the regenerative energy to be consumed through the resistor.	Separately installed
Braking resistor	3G3IV-PERF150WJ____	Shortens the motor deceleration time by causing the regenerative energy to be consumed through the resistor.	Separately installed

1-8-6 Peripheral Units

Name	Model (code No.)	Function
Radio noise protective filter	3G3IV-PHF_____ 3G3IV-PLF____	Use a radio noise filter to eliminate radio wave interference. It is provided at input terminals of the inverter main circuit.
Isolator	K3FK	Isolates the inverter input and output signals to reduce induced noise.

SECTION 2

Digital Operator (3G3IV-PJVOP100)

The digital operator can perform operation sequence, function selection, constant setting, operation status monitor and display of fault contents by connecting it to the inverter by using the special-use extension cable.

2-1	Installation	26
2-2	Description of Digital Operator Display and Operating Sections	28
2-3	Outline of Functions	29
2-4	Function/Constant Setting	29
2-5	Digital Operator Operation Example	32
2-6	Constant Initialization and Write-in Prohibit	34
2-6-1	Constant Initialization (Operation to Return to Factory Setting) ..	34
2-6-2	Constant Write-in Prohibit (Only Constant Reading Possible)	34
2-7	Corrective Function	34
2-7-1	Adjustment of Frequency Setting Value, Output Frequency Bias (No. 23) and Gain (No. 22)	34
2-7-2	Calibration of Frequency Meter	35
2-8	Monitor	36
2-9	Function/Constant List	38
2-10	Description of Functions and Constants	43
2-10-1	Password Setting	43
2-10-2	Operation Mode Selection	44
2-10-3	V/f Characteristics Setting	44
2-10-4	9-step Speed Change	45
2-10-5	Jog Operation	45
2-10-6	Accel/Decel Time and Patterns	46
2-10-7	Output Frequency Control (Gain/Bias)	46
2-10-8	Electronic Thermal Overload Function	47
2-10-9	Multi-function Analog Output Monitor	47
2-10-10	Output Frequency Limit	47
2-10-11	DC Injection Braking	48
2-10-12	Motor Stall Prevention Function	48
2-10-13	Full-range Automatic Torque Boost	49
2-10-14	Multifunction Contact Input Function Selection	49
2-10-15	Multifunction Output Function	50
2-10-16	Frequency/Current Meter Calibration	50
2-10-17	Overtorque Detection Function	50
2-10-18	Carrier Frequency	51
2-10-19	Speed Agreed Signal Output	51
2-10-20	S-curve at Accel/Decel Time	52
2-10-21	Momentary Power Loss Protection	53
2-10-22	No. of Auto Reset/Restart Operation (No. 47)	53
2-10-23	Setting Prohibit Frequency Range (No. 50 to No. 53)	54
2-10-24	Speed Search Function	54
2-10-25	Output Voltage Limiter	56
2-11	Protection Function	57
2-12	Warning and Self-diagnosis Functions	59

Function List

For reading (read-out) or setting (write-in) of functions or constant	Par. 2.4
For digital operator single-unit operation	Par. 2.5
For changing set value to factory setting again	Par. 2.6.1
For function or constant write-in prohibit	Par. 2.6.2
For adjustment of relation between frequency reference and output frequency	Par. 2.7.1
For calibration of frequency meter or ammeter (externally connected)	Par. 2.7.2
For monitor function use	Par. 2.8

2-1 Installation

There are two installation methods for the digital operator: connecting the special extension cable for hand operation and mounting on the housing panel

The digital operator can be installed or removed while current is being applied or during run.

Handy Operation by Extension Cable

Make sure to mount the cable on the inverter.

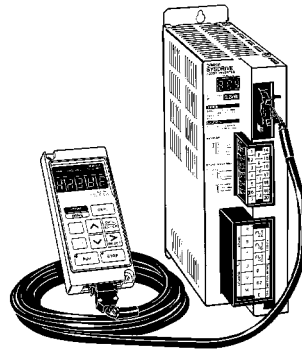

Mounting on Housing Panel

Cut the housing panel and mount the operator shown on the left.

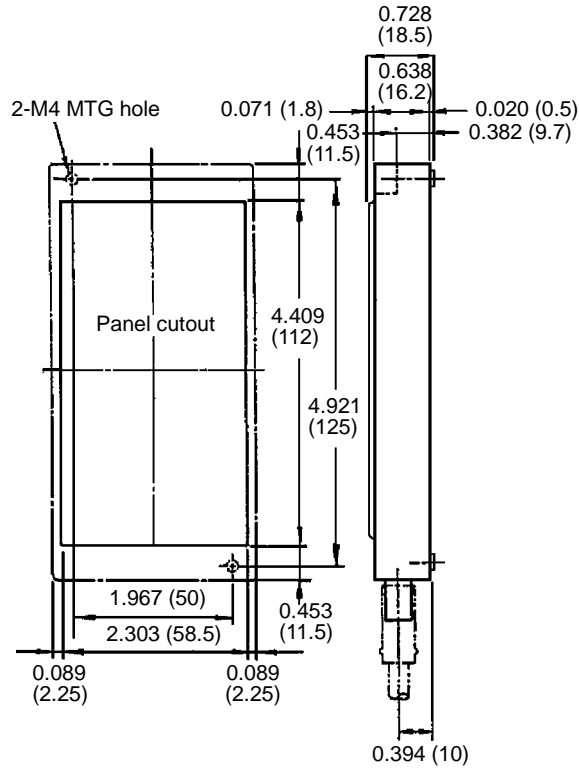

Note Use only the special extension cable. Two types of cables are available: 1 m and 3 m long.

2-2 Description of Digital Operator Display and Operating Sections

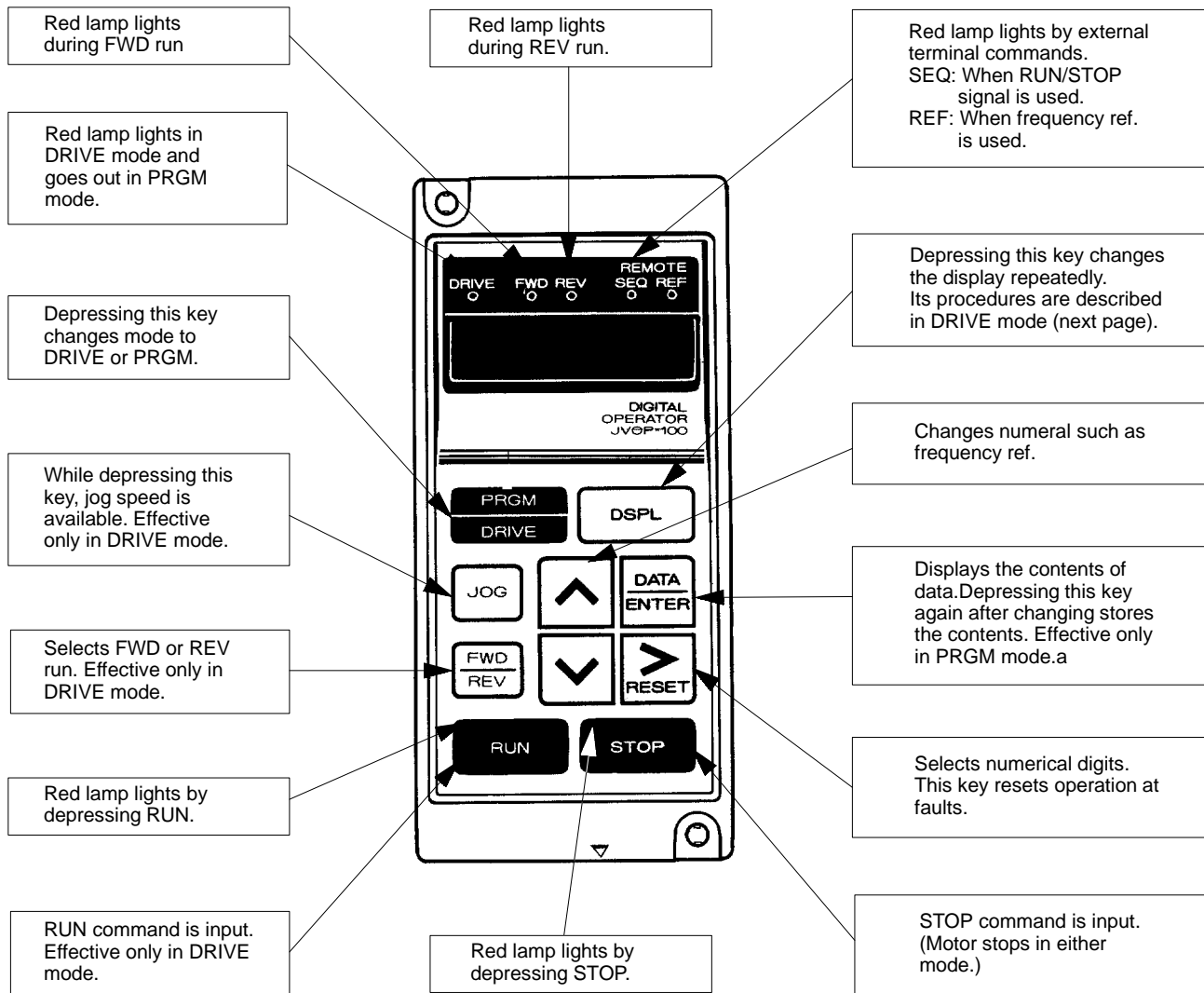

RUN or STOP lamp changes in accordance with the following operations:

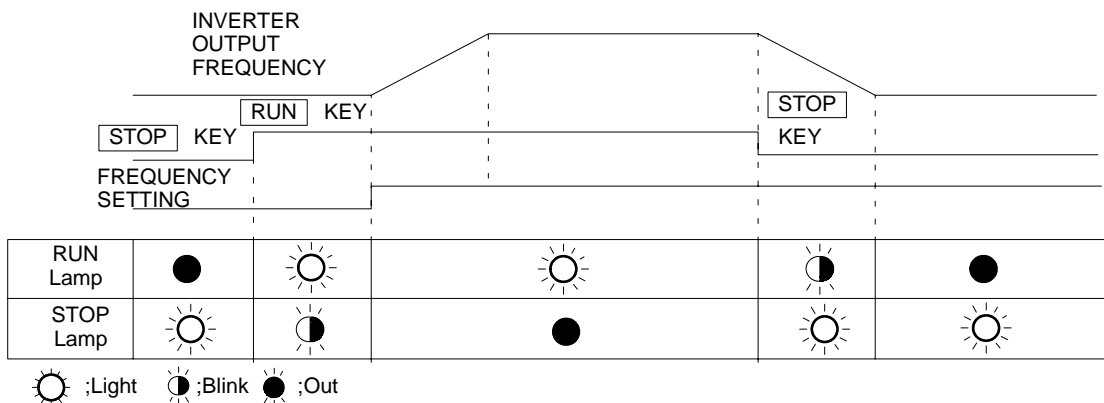

2-3 Outline of Functions

Main Functions

- Drive Mode** The 3G3SV operation sequence can be performed by simple key operation.
- Program Mode** All function selection and constant setting, belonging to the 3G3SV, can be set in digital.
- Monitor Function** Output frequency, output current or operation status such as RUN or STOP can be easily monitored.
- Fault Contents Display** If a fault occurs, the fault contents are displayed. The contents of the latest fault are stored, which helps maintenance, inspections or troubleshooting smoothly.

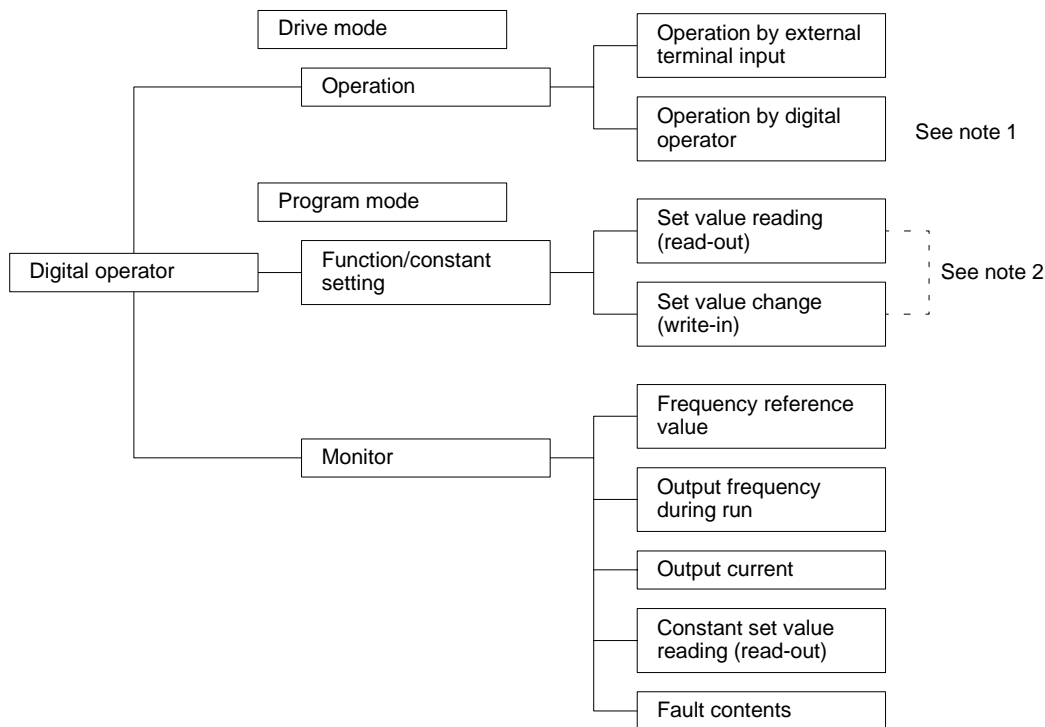

- Note**
1. Changed to the program mode and then to the operation mode by digital operator.
 2. Set values except for frequency reference values can be changed only during inverter stop.

2-4 Function/Constant Setting

DRIVE Mode and PRGM (Program) Mode

Selection of DRIVE mode or PRGM mode can be performed by using the

PRGM
DRIVE

 key when the inverter is stopped. When function selection or a change of set value is required, switch to the PRGM mode.

DRIVE Mode

Operation is enabled.

An operation can be performed by , , , or

keys.

Frequency reference value can be changed during running.

PRGM Mode

Program (function selection, constant setting) can be changed.

Display Contents of DRIVE Mode and PRGM Mode

Display contents of the digital operator differ according to selected mode (PRGM/DRIVE).

The constant group to be displayed is changed each time display selection key is depressed.

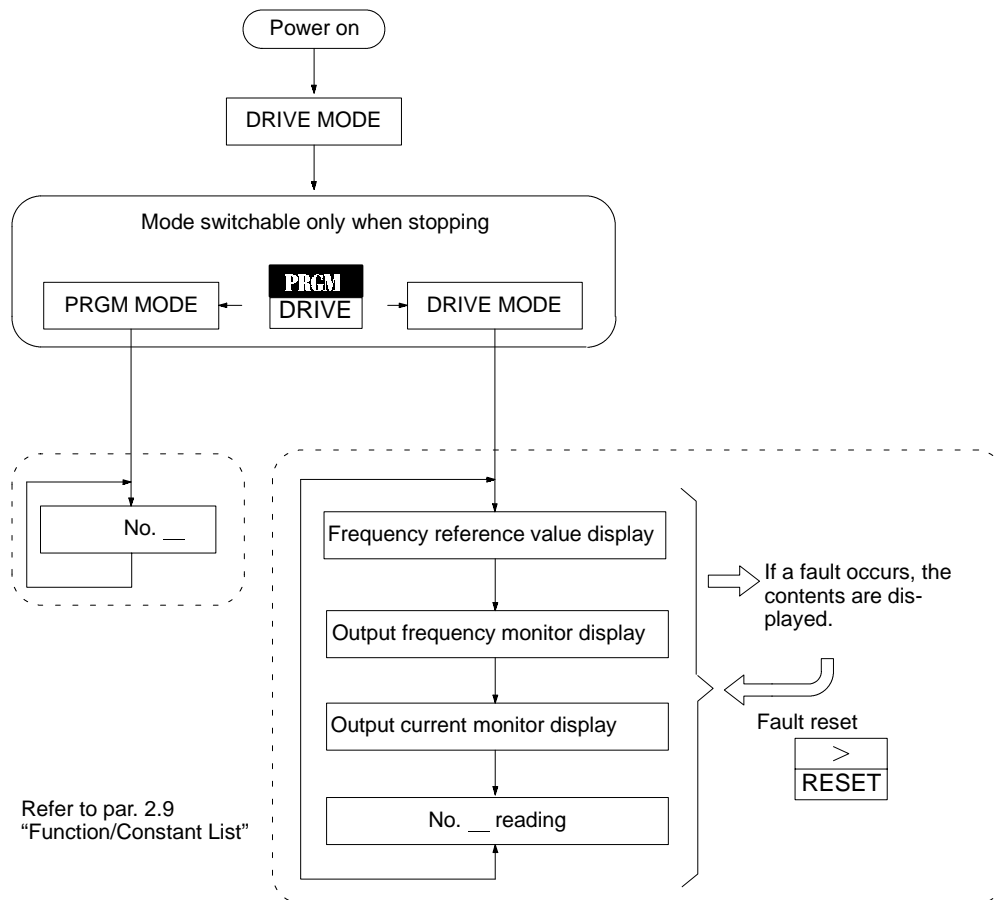

Constant Reading and Setting

The 3G3SV has various functions for optimum operation. Use it with the set values according to the load conditions or operation conditions of the matching machine. Set values are read or set by the digital operator. Selection methods differ according to the functions.

- 1, 2, 3...**
1. 1st functions
Main functions used often for operation conditions: No. 00 = 1 (factory setting)
 2. 2nd and 3rd functions
Functions to which constants in accordance with load conditions are set: No. 00 = 2 or 3
For the contents of the constants, refer to page 40 and 41.

Typical Setting

The following shows an example where acceleration time (No. 9) is changed from 10 s to 5 s.

Other constants can be changed in the same operation.

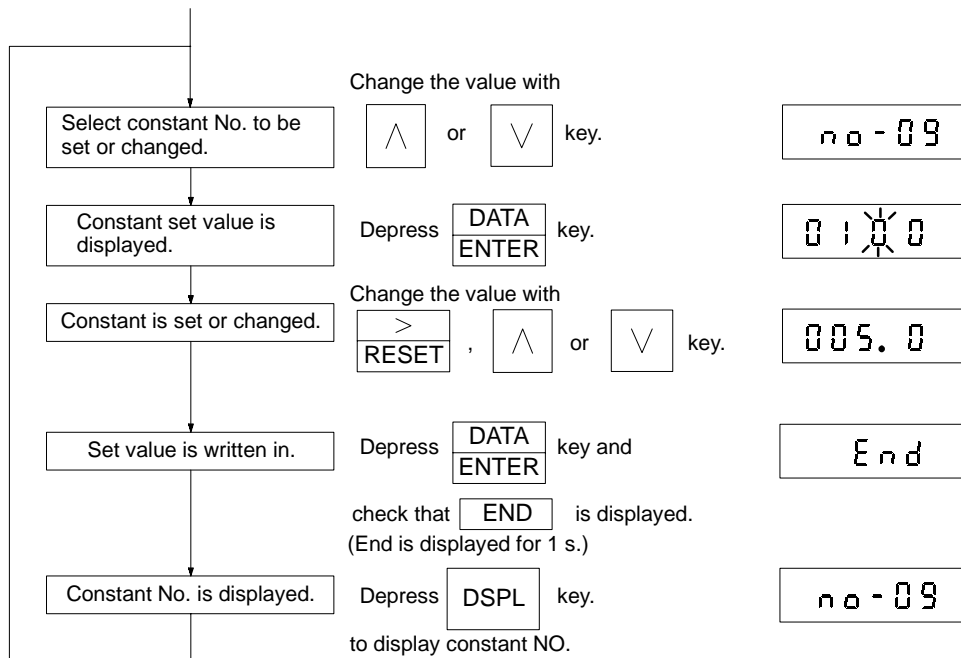

Note: Check that END is displayed for each constant setting. Constants cannot be changed simultaneously.

Precautions on Constant Setting

In the following cases, the set value blinks for 3 s and the data before changing are returned.

- 1, 2, 3...**
1. When a value exceeding the setting range is set
 2. Set values of constants No. 32 and No. 33 are not in descending order.
 3. If the following conditions are not satisfied in the V/f constant setting:
Maximum frequency (No. 02) \geq Base frequency (No. 04) $>$ Intermediate frequency (No. 05) \geq Minimum output frequency (No. 07).
For the following setting, intermediate frequency voltage (No. 6) is disregarded:
Intermediate frequency = Minimum frequency.

- 4. If the following condition is not satisfied in the frequency reference constant setting:
Set frequency reference (Nos. 13 to 17, 41 to 44) \leq Maximum frequency (No. 2)
For the details, refer to V/f Constant Setting on page 44.

2-5 Digital Operator Operation Example

The following shows an example of digital operator operation.

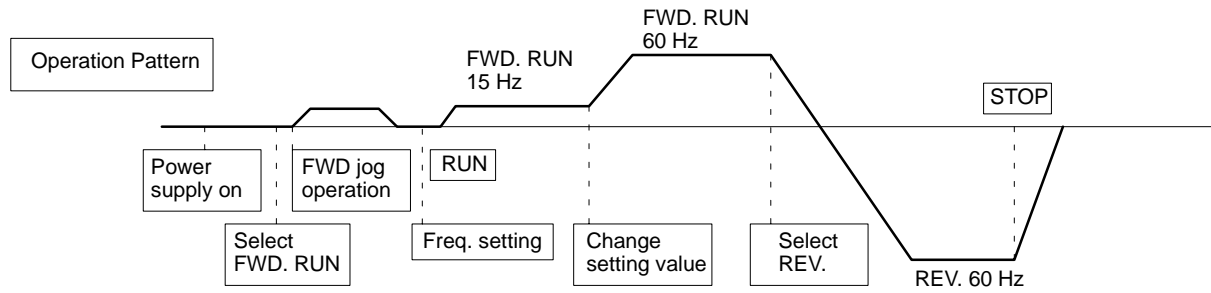

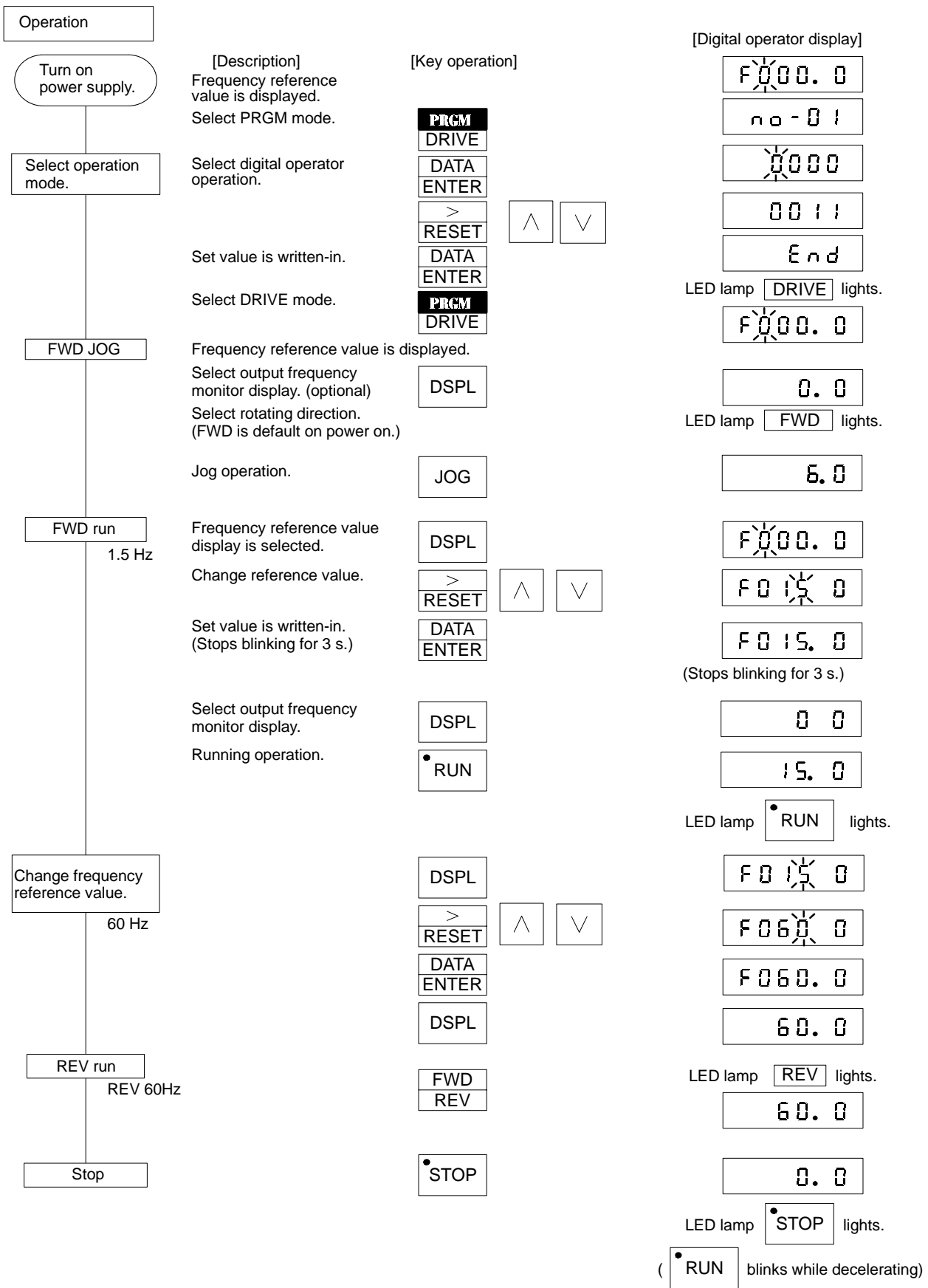

2-6 Constant Initialization and Write-in Prohibit

2-6-1 Constant Initialization (Operation to Return to Factory Setting)

Write-in 8 to constant No. 00.

Description	Key Operation	Digital Operator Display					
Select PRGM mode.	<table border="1"><tr><td>PRGM</td></tr><tr><td>ENTER</td></tr></table>	PRGM	ENTER	<table border="1"><tr><td>no-01</td></tr></table>	no-01		
PRGM							
ENTER							
no-01							
Select constant (No. 00).	<table border="1"><tr><td>∇</td></tr></table>	∇	<table border="1"><tr><td>no-00</td></tr></table>	no-00			
∇							
no-00							
Constant (No. 00) is displayed.	<table border="1"><tr><td>DATA</td></tr><tr><td>ENTER</td></tr></table>	DATA	ENTER	<table border="1"><tr><td>01</td></tr></table> See note 1	01		
DATA							
ENTER							
01							
Change the set value.	<table border="1"><tr><td>></td></tr><tr><td>RESET</td></tr></table> <table border="1"><tr><td>∧</td></tr></table> <table border="1"><tr><td>∇</td></tr></table>	>	RESET	∧	∇	<table border="1"><tr><td>08</td></tr></table> See note 2	08
	>						
RESET							
∧							
∇							
08							
	<table border="1"><tr><td>DATA</td></tr><tr><td>ENTER</td></tr></table>	DATA	ENTER	<table border="1"><tr><td>End</td></tr></table>	End		
DATA							
ENTER							
End							

- Note**
1. Differs according to the setting data before changing.
 2. The display returns to 01 after write-in. This indicates that initialization is executed at writing-in the data.

2-6-2 Constant Write-in Prohibit (Only Constant Reading Possible)

Description	Key Operation	Digital Operator Display					
Select PRGM mode.	<table border="1"><tr><td>PRGM</td></tr><tr><td>ENTER</td></tr></table>	PRGM	ENTER	<table border="1"><tr><td>no-01</td></tr></table>	no-01		
PRGM							
ENTER							
no-01							
Select constant (No. 00).	<table border="1"><tr><td>∇</td></tr></table>	∇	<table border="1"><tr><td>no-00</td></tr></table>	no-00			
∇							
no-00							
Constant (No. 00) is displayed.	<table border="1"><tr><td>DATA</td></tr><tr><td>ENTER</td></tr></table>	DATA	ENTER	<table border="1"><tr><td>01</td></tr></table>	01		
DATA							
ENTER							
01							
Change the set value.	<table border="1"><tr><td>></td></tr><tr><td>RESET</td></tr></table> <table border="1"><tr><td>∧</td></tr></table> <table border="1"><tr><td>∇</td></tr></table>	>	RESET	∧	∇	<table border="1"><tr><td>00</td></tr></table> See note	00
	>						
RESET							
∧							
∇							
00							
	<table border="1"><tr><td>DATA</td></tr><tr><td>ENTER</td></tr></table>	DATA	ENTER	<table border="1"><tr><td>End</td></tr></table>	End		
DATA							
ENTER							
End							

- Note** Differs according to setting data before changing.

2-7 Corrective Function

2-7-1 Adjustment of Frequency Setting Value, Output Frequency Bias (No. 23) and Gain (No. 22)

Any desired value of output frequency for frequency set value (0 to 10 V or 4 to 20 mA) can be set.

Example

Adjust so as to obtain 10% speed (6 Hz) at frequency setting voltage 0 V and 100% speed (60 Hz) at 8 V.

Description	Key Operation	Digital Operator Display	
Select PRGM mode.	PRGM ENTER	no-01	
(Bias) Select constant (No. 23).	^	no-23	
Data (No. 23) are displayed.	DATA ENTER	0.00	
Change the set value.	> RESET ^ v DATA ENTER	0.10 (10 % = 0.1) End	

Description	Key Operation	Digital Operator Display
(Gain) Select constant (No. 22).	DSPL v	no-22
Data (No. 22) are displayed.	DATA ENTER	1.00
Change the set value.	> RESET ^ v DATA ENTER	1.23 End

2-7-2 Calibration of Frequency Meter

Calibration of frequency meter or ammeter connected to the inverter can be performed even without providing a calibration resistor.

Example

When the frequency meter specifications are 3 V and 1 mA scale, operation is performed at 60 Hz with a frequency setting voltage of 10 V.

Description	Key Operation	Digital Operator Display
Select constant (No. 45).	DSPL ^ v	no - 45
Data are displayed.	DATA ENTER	1.00
Change the set value.	> RESET ^ v	0.30 ... 10 V * 0.3 = 3.0 V
	DATA ENTER	End

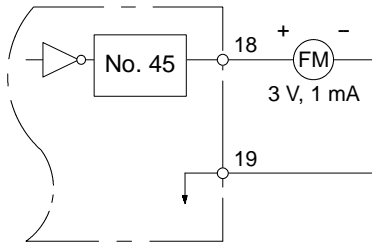

FREQ. meter calibration

2-8 Monitor

Frequency reference value, output frequency, output current and fault contents can be monitored.

Typical Monitor Contents and Display

The monitor item is changed every time when the DSPL key is depressed.

Key Operation

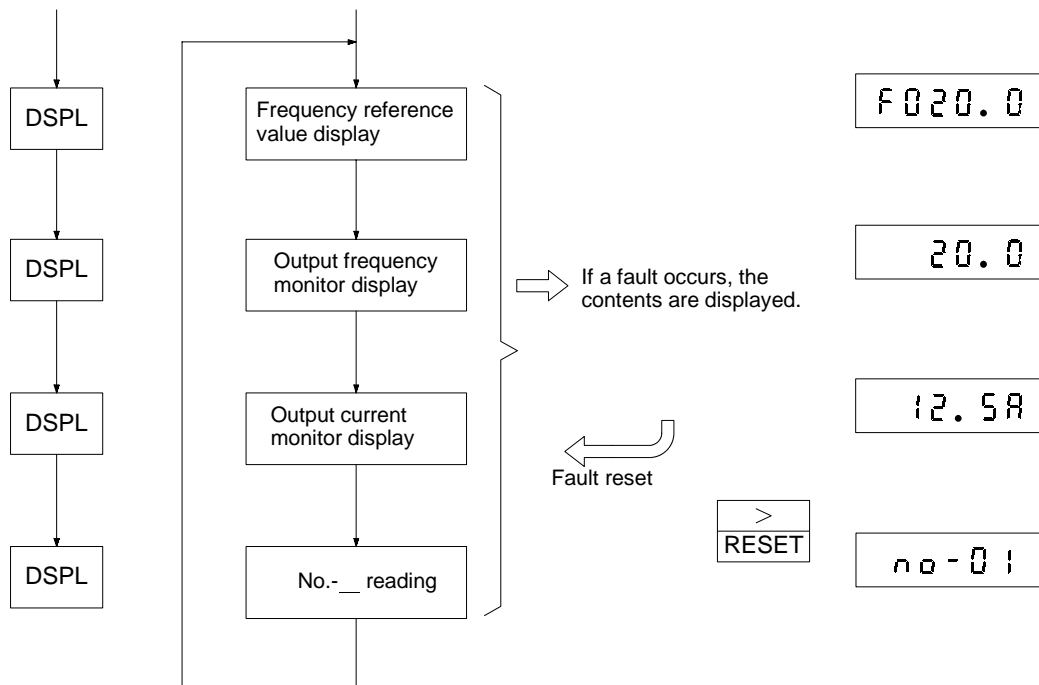

Monitoring of Fault Contents

If a fault occurs, the fault contents are displayed with priority over other display items. Depress the

>
RESET

 key to reset the fault.

Since the latest fault content data are stored, even if the power supply is turned off, they can be monitored after the power supply is turned on again.

- 1, 2, 3...**
1. Checking fault contents
The latest data are stored in the constant No. 48. (except uU)
 2. Clearing fault contents
The contents are cleared by setting "6" the constant No. 0 (No. 00).

2-9 Function/Constant List

First Functions (Constant Nos. 0 to 19)

Function	No.	Name	Description	Initial setting	User set values	See page
Password setting	0	Password	0: Password (No. 00) setting/reading and first function (constant Nos. 1 to 19) reading possible	1		43
Constant write-in prohibit			1: First function (constant Nos. 0 to 19) setting/reading possible			
Constant group selection			2: First and second function (constant Nos. 0 to 29) setting/reading possible			
Fault contents clear			3: First, second and third function (constant Nos. 0 to 59) setting/reading possible			
Constant initialization			6: Fault record clear			
			8: Initialize (multifunction terminal: initial value setting)			
			9: Initialize (3-wire sequence)			
Operation method selection	1	Run signal selection 1	1st digit = 0: Main frequency reference-external terminals 11 and 13 inputs 1: Main frequency reference-operator Fxxxx	0000		44
Stopping method selection			2nd digit = 0: Run by external terminal run command 1: Run by operator run command			
Output voltage limiter			3rd digit = 0: Deceleration to a stop 1: Coasting to a stop			
		Output voltage limiter	4th digit = 0: With output voltage limiter 1: Without output voltage limiter			56
V/f characteristic setting	2	Maximum frequency	Setting unit: 0.1 Hz, setting range: 50.0 to 400.0 Hz	60.0 Hz		44
	3	Maximum voltage	Setting unit: 0.1 V, setting range: 0.1 to 255.0 V	200.0 V		44
	4	Maximum voltage frequency (base frequency)	Setting unit: 0.1 Hz, setting range: 0.1 to 400.0 Hz	60.0 Hz		44
	5	Intermediate output frequency	Setting unit: 0.1 Hz, setting range: 0.1 to 400.0 Hz	1.5 Hz		44
	6	Intermediate output frequency voltage	Setting unit: 0.1 V, setting range: 0.1 to 255.0 V	12.0 V		44

Function	No.	Name	Description	Initial setting	User set values	See page
	7	Minimum output frequency	Setting unit: 0.1 Hz, setting range; 0.1 to 10 Hz	1.5 Hz		44
	8	Minimum output frequency voltage	Setting unit: 0.1 V, setting range: 0.1 to 50 V	12.0 V		44
First accel/decel time setting	9	Acceleration time 1	Setting unit: 0.1 s, setting range: 0.0 to 600.0 s	10.0 s		46
	10	Deceleration time 1	Setting unit: 0.1 s, setting range: 0.0 to 600.0 s	10.0 s		46
Second accel/decel time setting	11	Acceleration time 2	Setting unit: 0.1 s, setting range: 0.0 to 600.0 s	10.0 s		46
	12	Deceleration time 2	Setting unit: 0.1 s, setting range: 0.0 to 600.0 s	10.0 s		46
Frequency reference (see note 1)	13	Frequency reference 1	Setting unit: 0.1 Hz, setting range: 0.0 to 400.0 Hz	0.0 Hz		45
	14	Frequency reference 2	Setting unit: 0.1 Hz, setting range: 0.0 to 400.0 Hz	0.0 Hz		45
	15	Frequency reference 3	Setting unit: 0.1 Hz, setting range: 0.0 to 400.0 Hz	0.0 Hz		45
	16	Frequency reference 4	Setting unit: 0.1 Hz, setting range: 0.0 to 400.0 Hz	0.0 Hz		45
	17	Jogging frequency reference	Setting unit: 0.1 Hz, setting range: 0.0 to 400.0 Hz	6.0 Hz		45
Electronic thermal overload motor protection	18	Motor protection selection	1st digit = 0: Electronic thermal overload motor protection provided 1: Electronic thermal overload motor protection not provided 2nd digit = 0: Electronic thermal overload characteristic is for standard motor 1: Electronic thermal overload characteristic is for constant torque motor 3rd digit Not used 4th digit: Not used	0000		47
Electronic thermal overload reference current	19	Motor rated current	Setting unit: 0.1 A, setting range: 10% to 120% of inverter rated current	1.9 A (see note 2)		47

- Note**
1. Can be changed even during run.
 2. Initial setting differs according to the inverter capacity. the values in the above list are provided when model 3G3SV-B2004 (0.4 kW) and standard motor 200 V 60 Hz. 0.4 kW are combined. Set the values described in the motor nameplate.

Second Functions (Constant Nos. 20 to 29)

Function	No.	Name	Description	Initial setting	User set values	See page
REV run prohibit	20	Run signal selection 2	1st digit = 0: REV run enabled = 1: REV run disabled	0000		44
Operator stop key precedence			2nd digit = 0: STOP key effective = 1: STOP key ineffective			
External fault input selection			3rd digit = 0: External fault (terminal 3) - NO contact input = 1: External fault (terminal 3) - NC contact input			
Stall prevention during deceleration			4th digit = 0: Stall prevention during deceleration provided = 1: Stall prevention during deceleration not provided (at braking resistor connected)			
Inverter display unit monitor built-in selection	21	Output monitor selection	1st digit = 0: Inverter monitor - output frequency display = 1: Inverter monitor - output current display	0000		47
Analog monitor selection			2nd digit = 0: Analog monitor - output frequency = 1: Analog monitor - output current (Analog monitor gain s set by constant No. 45.)			
S-curve at accel/decel time			S-curve at accel/decel time S-curve: 0.2 s 3rd digit = 0, 4th digit = 1 No S-curve 3rd digit = 0, 4th digit = 0 S-curve: 0.5 s 3rd digit = 1, 4th digit = 0 S-curve: 1.0 s 3rd digit = 1, 4th digit = 1			
	22	Frequency reference gain	Setting unit: 0.01, setting range: 0.01 to 2.00	1.00		46
	23	Frequency reference bias	Setting unit: 0.01, setting range: -1.00 to 1.00	0.00		46
Frequency limit control	24	Frequency upper limit	Setting unit: 1%, setting range: 0 to 110%	100%		47
	25	Frequency lower limit	Setting unit: 1%, setting range: 0 to 110%	0%		
DC injection braking	26	DC injection braking current	Setting unit: 1%, setting range: 0 to 110%	50%		48
	27	DC injection braking time at stop	Setting unit: 0.1 s, setting range: 0.0 to 5.0 s	0.5 s		
	28	DC injection braking time at start	Setting unit: 0.1 s, setting range: 0.0 to 5.0 s	0.0 s		
Torque compensation	29	Automatic torque boost gain	Setting unit: 0.1, setting range: 0.0 to 3.0	1.0		49

Note When setting the second function, set n%-0 to 2 or 3.

Third Functions (Constant Nos. 30 to 49)

Function	No.	Name	Description	Initial setting	User set values	See Page	
Stall Prevention	30	Level of stall preventive operation during acceleration	Setting unit: 1%, setting range 30% to 200% Note: Stall prevention is not performed during acceleration when 200% is set.	170%		48	
	31	Level of stall preventive operation during running	Setting unit: 1%, setting range 30% to 200% Note: stall prevention is not performed during run when 200% is set.	160%			
Multi-function selection	Contact input signal	32	Multifunction input selection 1 (terminal 7 function selection)	0: FWD/REV run command (3-WIRE sequence selection) 1: JOG command 2: Accel/decel time change 3: Multi-step speed reference 3 4: External baseblock (NO contact input) 5: External baseblock (NC contact input) 6: Speed search from max. frequency 7: Speed search from set frequency	1		49
		33	Multifunction input selection 2 (terminal 8 function selection)	1: JOG command 2: Accel/decel time change 3: Multi-step speed reference 3 4: External baseblock (NO contact input) 5: External baseblock (NC contact input) 6: Speed search from max. frequency 7: Speed search from set frequency	2		
	Photo-coupler output signal	34	Multifunction input selection 1 (terminal 14 function selection)	0: Running 1: Frequency coincidence 2: Zero speed 3: Frequency detection (output frequency \geq frequency detection level) 4: Overtorque detection	0		
35		Multifunction input selection 2 (terminal 15 function selection)	0: Running 1: Frequency coincidence 2: Zero speed 3: Frequency detection (output frequency \geq frequency detection level) 4: Overtorque detection	1			
Desired speed detection	36	Frequency detection level	Setting unit: 0.1 Hz, setting range: 0.0 to 400.0 Hz	0.0 Hz		51	

Function	No.	Name	Description	Initial setting	User set values	See Page
Overtorque detection	37	Overtorque detection function selection	1st digit = 0: Overtorque detection not provided = 1: Overtorque detection provided	0000		50
			2nd digit = 0: Detected only during speed coincidence = 1: Detected during running			
			3rd digit = 0: Operation continued after overtorque detection = 1: Output shut-off at overtorque detection			
			4th digit: Not used			
	38	Overtorque detection level	Setting unit: 1%, setting range: 30% to 200%	160%		
	39	Overtorque detection time	Setting unit: 0.1 s, setting range: 0.1 to 10.0 s	0.1 s		
Carrier frequency adjustment	40	Carrier frequency	Setting unit: 2.5 kHz, setting range: 1 to 6 (2.5 to 15 kHz)	4 (10 kHz)		51
Multi-step speed frequency reference (see note)	41	Frequency reference 5	Setting unit: 0.1 Hz, setting range: 0.0 to 400.0 Hz	0.0 Hz		45
	42	Frequency reference 6	Setting unit: 0.1 Hz, setting range: 0.0 to 400.0 Hz	0.0 Hz		
	43	Frequency reference 7	Setting unit: 0.1 Hz, setting range: 0.0 to 400.0 Hz	0.0 Hz		
	44	Frequency reference 8	Setting unit: 0.1 Hz, setting range: 0.0 to 400.0 Hz	0.0 Hz		
Analog monitor scale calibration	45	Analog monitor gain	Setting unit: 0.01, setting range: 0.01 to 2.00	1.00		50
Momentary power loss protection	46		1st digit = 0: Operation stopped by momentary power loss detection = 1: Operation continues after momentary power loss	0000		43
Auto reset/restart operation	47	No. of auto restart attempts		0		43
Fault trace	48	Fault record	The latest fault is number of auto restart attempt: 0 to 10 (setting disabled).		---	

Function	No.	Name	Description	Initial setting	User set values	See Page
Software version	49	PROM No.	PROM No. is displayed (setting disabled).		---	
Frequency jump control	50	Setting prohibit frequency 1	Setting unit: 0.1 Hz, setting range: 0.0 to 400.0	0.0 Hz		54
	51	Setting prohibit frequency 2	Setting unit: 0.1 Hz, setting range: 0.0 to 400.0	0.0 Hz		
	52	Setting prohibit frequency 2	Setting unit: 0.1 Hz, setting range: 0.0 to 400.0	0.0 Hz		
	53	Setting prohibit frequency range	Setting unit: 0.1 Hz, setting range: 0.0 to 25.5	1.0 Hz		
Speed search control	54	Speed search deactivation current level	Setting unit: 1%, setting range: 0 to 200	150%		54
	55	Min. base-block time	Setting unit: 0.1 s, setting range: 0.0 to 5.0	0.5 s		
	56	V/F during speed search	Setting unit: 0.1 s, setting range: 0.0 to 100.0	100%		

- Note**
1. Can be changed even during run.
 2. When setting the third function, set n%-0 to 3.

2-10 Description of Functions and Constants

Constant Nos. are indicated as No. N.

2-10-1 Password Setting

Item name	Constant to be set	Factory preset
First function (0 to 19) selection	No. 0	1
First, second function (0 to 29) selection	No. 0	1
First, second, third function (0 to 49) selection	No. 0	1

The first functions (No. 0 to No. 19) can be set and read.
No. 0 = 1

The first and second functions (No. 0 to No. 29) can be set and read.
No. 0 = 2

The first, second and third functions (No. 0 to No. 59) can be set and read.
No. 0 = 3

2-10-2 Operation Mode Selection

Item name	Constant to be set	Factory preset
Parameter write disable	No. 0	1
Start/stop procedure	No. 1	0000
Reverse rotation prevention	No. 20	0000

Parameter Write Disable Prevents operation error.
No. 0 = 0

Start/Stop Procedure Control input can be selected from the digital operator or the terminal strip.

No. 1 = xx 00 (x means 1 or 0.)

0: Frequency command from external terminal
1: Frequency command from the operator

0: Start/stop control from external terminal
1: Start/stop control by the operator

Stop Procedure Stopping mode can be selected according to the application

No. 1 = x0xx

0: Ramp to stop
1: Coasting to a stop

Reverse Rotation Prevention Prevents accidental selection of reverse rotation.

No. 20 = xxx1

0: Reverse rotation is possible.
1: Reverse rotation is impossible.

2-10-3 V/f Characteristics Setting

Item name	Constant to be set	Factory preset
V/f constant	No. 2 to No. 8	Refer to page 38.

Any desired V/f pattern can be set for special specifications, too.

Any V/f pattern can be set according to the load characteristics. The factory preset value is set to 60 Hz saturation type pattern.

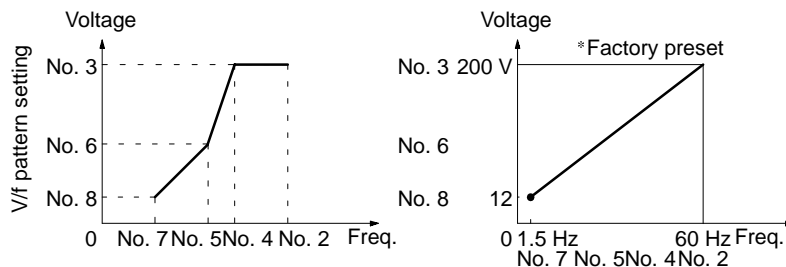

- Note**
1. The output voltage will not exceed the upper limit if the output voltage limiter function is used. To increase the output voltage ignoring the upper limit, do not use the output voltage limiter function. For details refer to 2-10-25 Output Voltage Limiter.
 2. If an excessively large value is set in low-speed area (3 Hz or less), motor overheating or inverter malfunction may occur.

2-10-4 9-step Speed Change

Item name	Constant to be set	Factory preset
Multi-speed frequency command	No. 13 to No. 17, No. 41 to No. 44	See page 39 and 42.
Multi-function command	No. 32 and No. 33	See page 41.

Up to 9 steps of speeds can be set using signals from external terminals 5 to 8. This eliminates the need for an analog signal thereby enabling operation by simplified external control. See the following example.

Set according to run specifications.

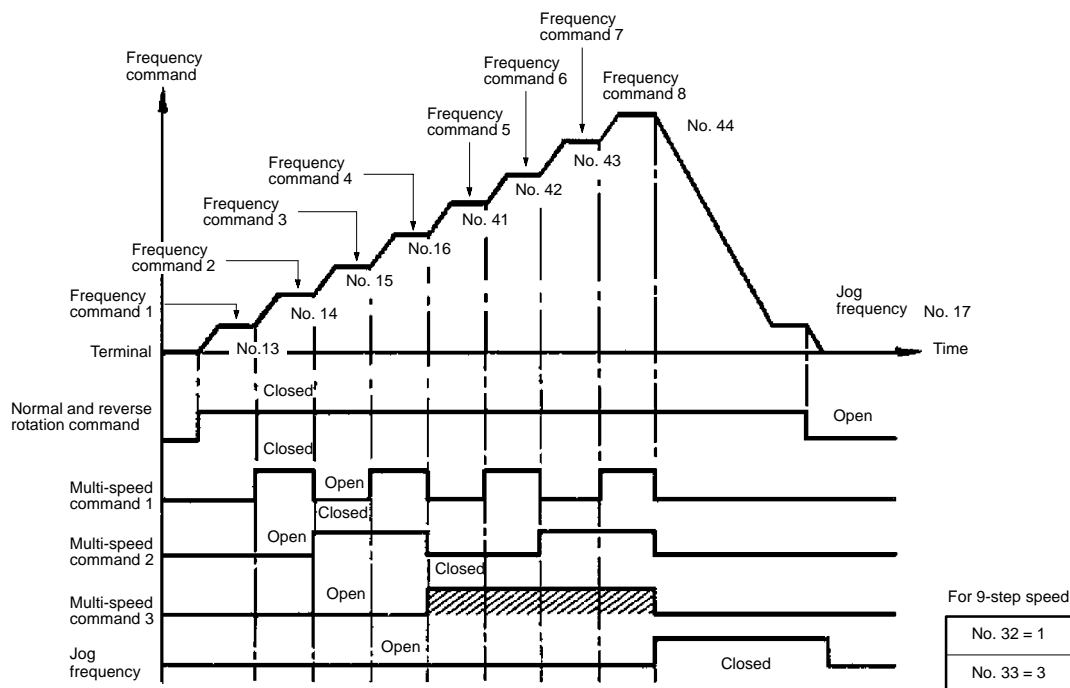

2-10-5 Jog Operation

Item name	Constant to be set	Factory preset
Jog frequency	No. 17	6.0 Hz

Select the jog mode (connect terminals 9 to 7) and input the start signal. Jog operation starts.

Depressing the key on the digital operator performs the same operation.

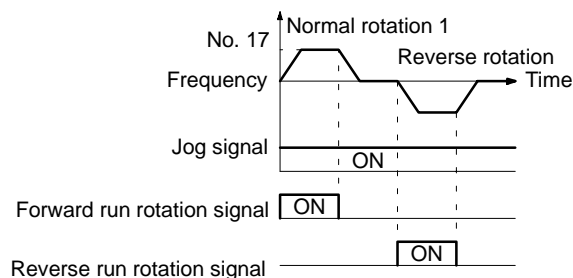

2-10-6 Accel/Decel Time and Patterns

Item name	Constant to be set	Factory preset
Acceleration time 1	No. 9	10.0 s
Deceleration time 1	No. 10	10.0 s
Acceleration time 2	No. 11	10.0 s
Deceleration time 2	No. 12	10.0 s

Each item can be set from 0.0 sec to 600.0 sec.

The set time indicates the interval required before the maximum output frequency No. 2 is reached.

Time marked with * can be set for two-step switching using an external contact.

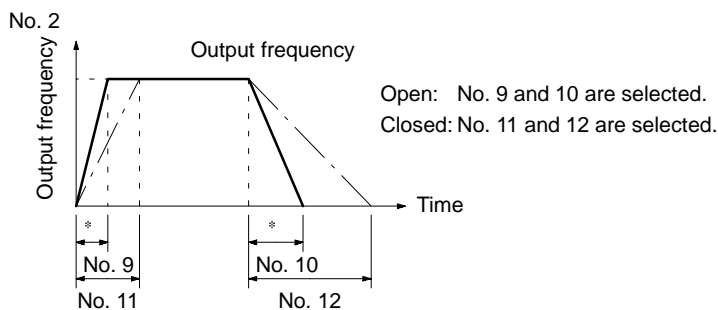

2-10-7 Output Frequency Control (Gain/Bias)

Item name	Constant to be set	Factory preset
Frequency command gain	No. 22	1.0
Frequency command bias	No. 23	0.00

Output frequency (gain/bias) can be set freely according to frequency setting (0 to 10 V or 4 to 20 mA)

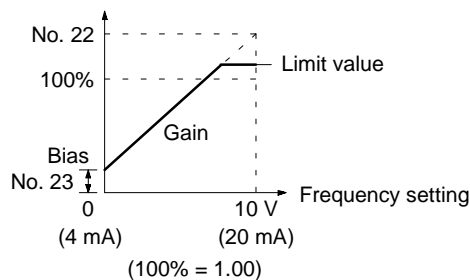

2-10-8 Electronic Thermal Overload Function

Item name	Constant to be set	Factory preset
Motor type	No. 18	0000
Motor rated current	No. 19	1.9 A (for B2004)

The electronic thermal overload function prevents standard motors from overloading when the speed is reduced by the inverter. (No external thermal switch is necessary.) Set as follows:

No. 18 = xx0x

- 0: Standard motors
- 1: Constant torque motors

Electronic thermal protection can be disabled by setting “No. 18 = xxx1.”

2-10-9 Multi-function Analog Output Monitor

Item name	Constant to be set	Factory preset
Output monitor selection	No. 21	0000

Output frequency or motor current can be monitored. (Standard function)

No. 21 = xx00

- 3-digits display section
- 0: Output frequency is displayed.
- 1: Motor current is displayed.
- 0: Output frequency is monitored.
- 1: Motor current is monitored.

Analog output monitor gain can be set to No. 45.

2-10-10 Output Frequency Limit

Item name	Constant to be set	Factory preset
Frequency (speed) command upper limit	No. 24	100%
Frequency (speed) command lower limit	No. 25	0

The upper and lower limits for the output frequency can be clamped. When the lower limit is not 0, acceleration to that lower limit setpoint begins immediately when the start command is input.

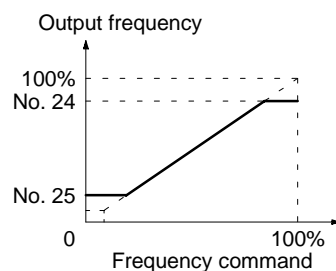

2-10-11 DC Injection Braking

Item name	Constant to be set	Factory preset
DC injection during stop	No. 27	See page 40.
DC injection at start	No. 28	See page 40.

DC Injection Braking During Stop

Prevents overrun at stop. (Exact position stop)

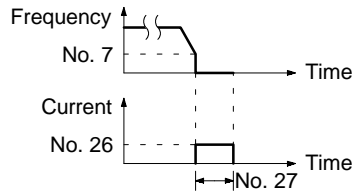

Starting DC Injection Braking During Start

Stops a coasting motor without tripping even when the direction of rotation is unknown.

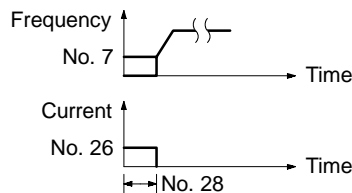

2-10-12 Motor Stall Prevention Function

Item name	Constant to be set	Factory preset
Operation level for stall prevention during acceleration	No. 30	170%
Operation level for stall prevention during running	No. 31	160%

Automatically adjusts output frequency according to the load so as to continue operation of the machine without stalling the motor.

Stall Prevention During Acceleration

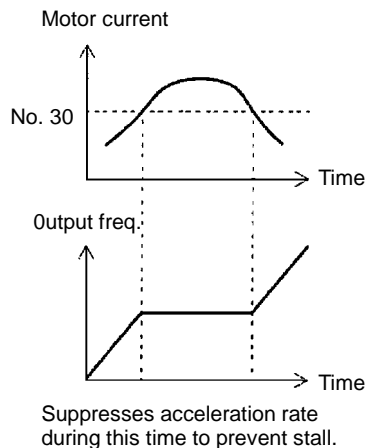

Stall Prevention During Running

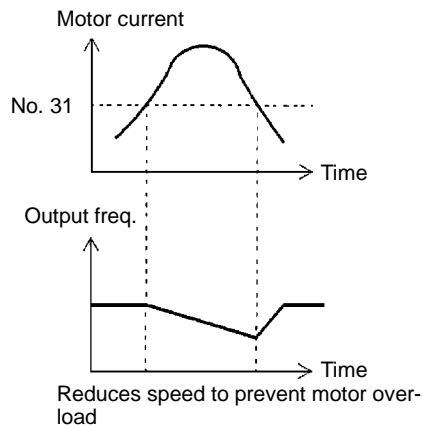

Stall Prevention During Deceleration

Set "1" for connecting braking resistor unit.

No. 20 = 0xxx

0: Stall prevention during deceleration enabled

1: Stall prevention during deceleration disabled

2-10-13 Full-range Automatic Torque Boost

Item name	Constant to be set	Factory preset
Torque compensation gain	No. 29	1.0

Automatic control of V/f ratio according to the load torque ensures tripless operation and optimum output current. Normally, no adjustment is necessary. Use this function especially when motor capacity is smaller than inverter capacity and torque is required.

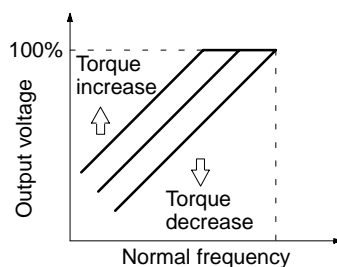

2-10-14 Multifunction Contact Input Function Selection

Item name	Constant to be set	Factory preset
Multifunction contact input function	No. 32 and No. 33	Refer to page 41.

The function of external output terminals 7 and 8 can be changed if necessary. Set No. 32 and No. 33 in the descending order.

Terminal 7 function: set to No. 32.

Terminal 8 function: set to No. 33.

Set value	Function
0 (see note 1)	FWD/REV run command (3-WIRE sequence selection)
1 (see note 2)	JOG command
2 (see note 2)	Accel/decel time change
3	Multi-step speed reference 3
4	External baseblock (NO) contact input
5	External baseblock (NC) contact input
6	Search from max. frequency
7	Search from set frequency

- Note**
1. "0" can be set only to 32.
 2. Factory preset value

Terminal function at 3-WIRE sequence selection

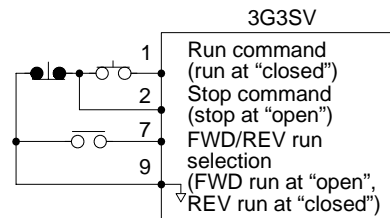

2-10-15 Multifunction Output Function

Item name	Constant to be set	Factory preset
Multifunction output function	No. 34 and No. 35	Refer to page 41.

Functions of external output terminals 14 to 16, and 15 and 16 can be switched.

Function of terminal 14 to 16: set into No. 34.

Function of terminal 15 and 16: set into No. 35.

Set value	Function
0 (see note)	In operation
1 (see note)	Frequency agreed
2	Zero speed
3	Frequency detection (output frequency \geq frequency detection level)
4	Overtorque detected

2-10-16 Frequency/Current Meter Calibration

Item name	Constant to be set	Factory preset
Analog output gain	No. 45	1.00
analog output selection	No. 21	0000

Frequency/current meter connected to the inverter can be calibrated without using a resistor for calibration.

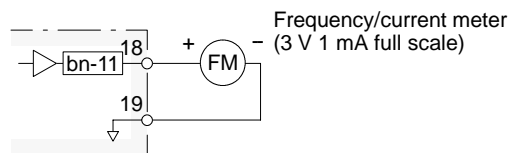

No. 21 = xx0x

- 0: Output frequency meter
- 1: Output current meter

2-10-17 Overtorque Detection Function

Item name	Constant to be set	Factory preset
Overtorque detection level	No. 38	160%
Overtorque detection time	No. 39	0.1 s
Overtorque detection signal	No. 34 and No. 35	Refer to page 41.
Overtorque detection selection	No. 37	Refer to page 42.

When excess load is placed on the machine, the increase in motor current is detected and alarm signal can be output.

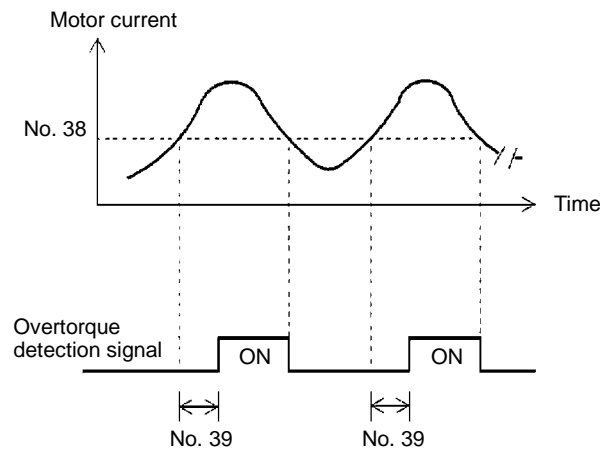

2-10-18 Carrier Frequency

Item name	Constant to be set	Factory preset
Carrier frequency upper limit	No. 40	4

Changing the carrier frequency reduces RFI noise and leakage current without increasing motor noise.

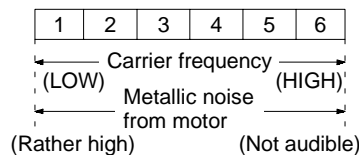
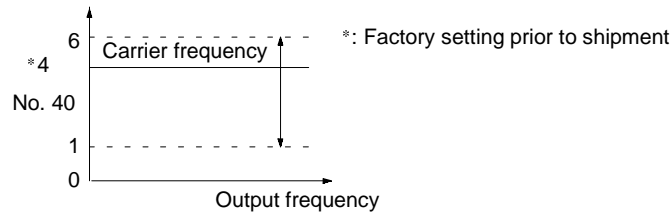

Note Reduce continuous output current for changing the frequency to 5 or 6.

2-10-19 Speed Agreed Signal Output

Item name	Constant to be set	Factory preset
Frequency detection level	No. 36	0.0 Hz
Multifunction contact output function	No. 34 and No. 35	Refer to page 41.

This function is used when operation at an arbitrary speed must be indicated. Set the multifunction contact output (No. 34, No. 35) as follows:

Set Value = 1: Frequency Agreed

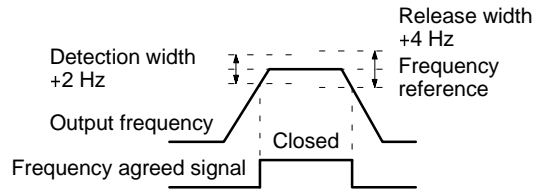

Set Value = 3: Set Value or More

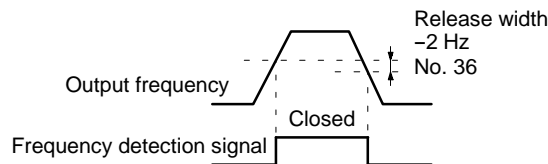

2-10-20 S-curve at Accel/Decel Time

Item name	Constant to be set	Factory preset
S-curve at accel/decel time	No. 21	0000

Digit 3, Digit 4 (S-curve Selection of Soft Starter)

The S-curve characteristics of the soft starter depend on the setting of digits 1 and 2 as follows:

- | | | |
|----------|----------|---------------------------------------|
| (Digit 4 | Digit 3) | |
| 0 | 1: | The S-curve characteristics is 0.2 s. |
| 0 | 0: | No S-curve characteristics |
| 1 | 0: | The S-curve characteristics is 0.5 s. |
| 1 | 1: | The S-curve characteristics is 1 s. |

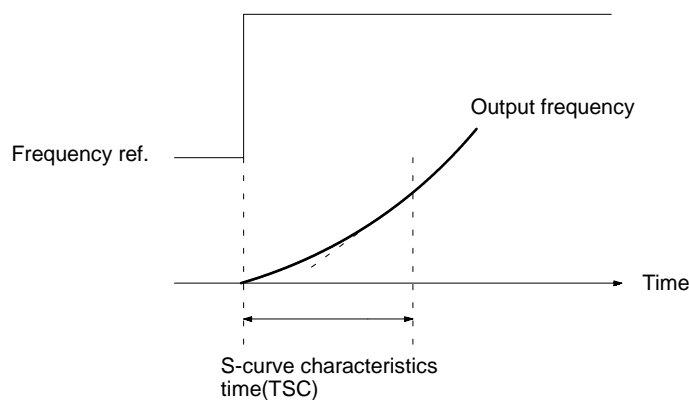

Note S-curve characteristics time refers to the time from acceleration rate 0 to the time when a normal acceleration rate determined by a specified acceleration time is obtained.

- 1, 2, 3...** 1. Time chart at FWD/REV run change with S-curve characteristics

The figure below shows the time chart at FWD/REV run change during deceleration and stop.

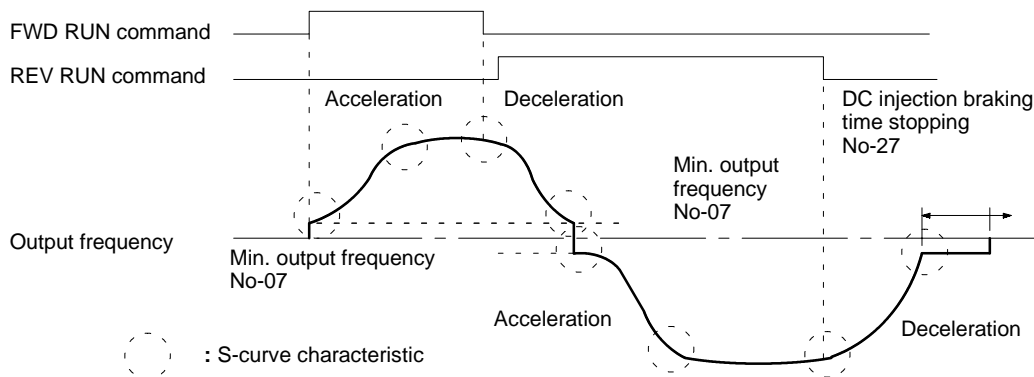

Note When digits 3 and 4 are 00, no S-curve characteristics at completion of deceleration.

2. Time chart at FWD/REV run change without S-curve characteristics

The figure below shows the time chart at FWD/REV run change during deceleration and stop.

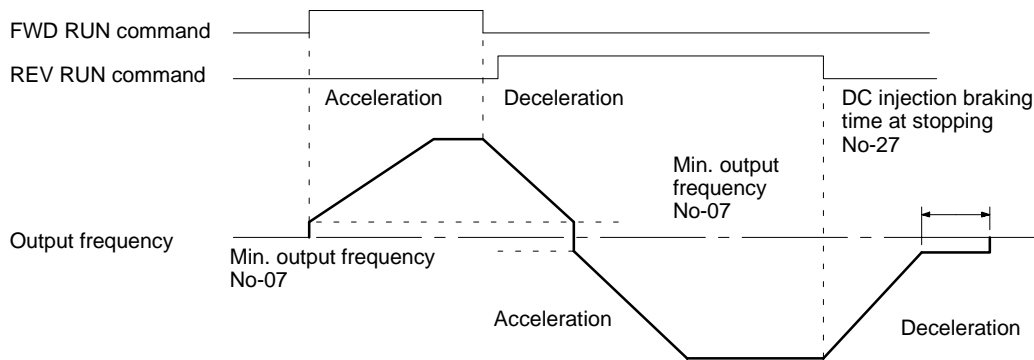

2-10-21 Momentary Power Loss Protection

Item name	Constant to be set	Factory preset
Operation continued at momentary power loss	No. 46	0000

Operation Continued at Momentary Stop

Digit 1 = 0: When momentary stop is detected, power failure (UV fault) occurs and the inverter output is shut off.

Digit 1 = 1: If momentary stop time is within momentary assurance time (see note), the operation continues after the momentary stop. If the momentary assurance time is exceeded, the inverter output is shut off.

Note 0.75 kW max.: Approximately 1 s.
1.5 kW max.: Approximately 2 s.

2-10-22 No. of Auto Reset/Restart Operation (No. 47)

Set the number of auto reset/restart operation. Setting of zero causes no auto reset/restart operation.

Each time one of OC, OV, OH, or GF fault occurs, one is added to the number of auto reset/restart operation, and auto reset/restart operation is performed according to the following procedure. However, auto reset/restart operation is not performed in the following cases:

Note GF is for single-phase input models only.

The number of auto reset/restart operation is cleared to zero when:

- 1, 2, 3... 1. No fault occurs for 10 minutes or more.
- 2. A fault reset signal is input from external terminals or digital operator.

2-10-23 Setting Prohibit Frequency Range (No. 50 to No. 53)

Set the range of setting prohibit frequency in the units of 0.1 Hz. The range of the setting prohibit frequency is determined as follows, depending on combinations with No. 50 to No. 52.

No. 50 to No. 52 – No. 53 ≤ the range of the setting prohibit frequency ≤ No. 50 to No. 52 + No. 53

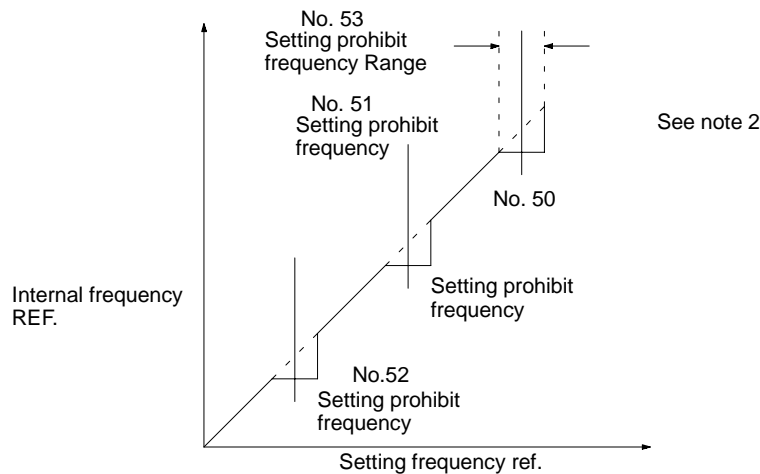

- Note**
- 1. Constant-speed operation is prohibited in the setting prohibit frequency range. Output frequency does not jump during acceleration or deceleration, which is performed smoothly.,
 - 2. Set as follows; No. 50 ≥ No. 51 ≥ No. 52

2-10-24 Speed Search Function

Item name	Constant to be set	Factory preset
Multifunction contact input function	No. 32, 33	---
Speed search deactive current level	No. 54	150%
Minimum baseblock time	No. 55	0.5 s
V/f during speed search	No. 56	100%

Search Command (Set Value = 6, 7) (No. 32 or No. 33)

When search command is “closed” during baseblock, speed search is started after inverter output is shut off for the minimum baseblock time.

Search commands with set values of 6 and 7 cannot be set at the same time.

Set value = 6: Speed search starts with the maximum frequency.

Set value = 7: Speed search starts with the frequency reference value when search command is input.

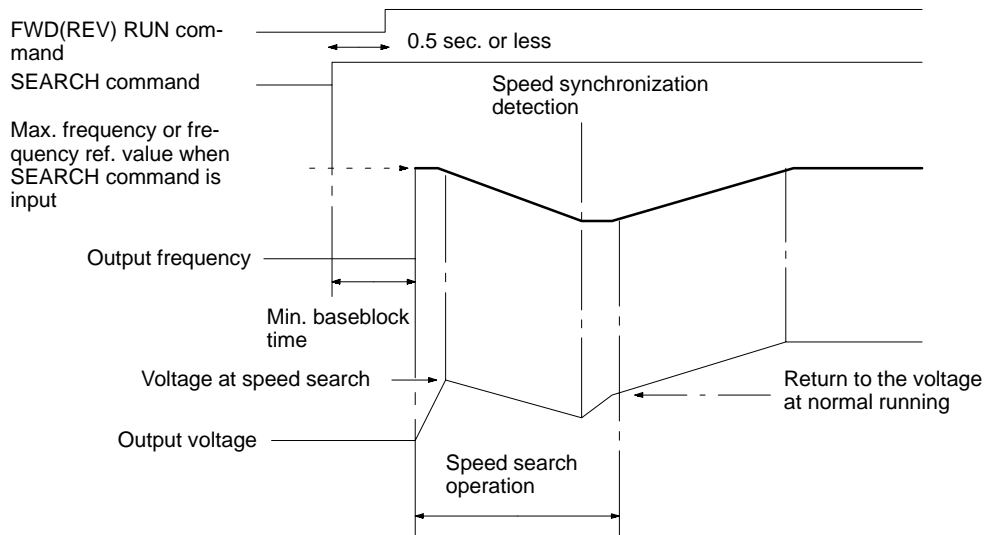

- Note**
1. In momentary stop operation continuation mode, speed search operation is performed beginning with current output frequency, regardless of the existence of search command. After completion of speed search, the operation is performed according to the run command.
 2. Determine a sequence so that FWD/REV run command enters at the same time or later than search command.

Example of Sequence

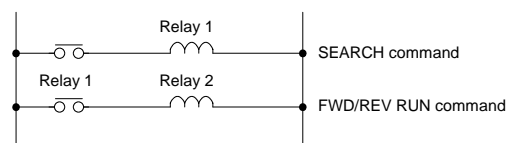

Speed Search Deactivation Current Level (No. 54)

When inverter output current immediately after power recovery is larger than the set value of No. 54, speed search operation is started. When inverter output current is smaller than the set value of No. 54, the frequency is interpreted as a speed synchronization point and acceleration or deceleration is performed again up to a specified frequency.

Minimum Baseblock Time (No. 55)

On detecting momentary power loss, the inverter shuts off output and maintains the baseblock state for a given time. Set in No. 55 the time when residual voltage is expected to be almost zero.

When momentary power loss time is longer than the minimum baseblock time, speed search operation is started immediately after power recovery.

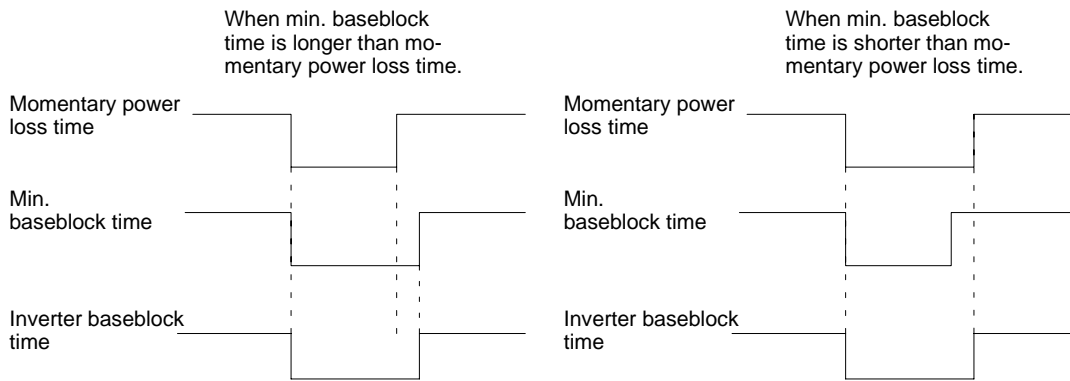

V/f During Speed Search (No. 56)

To ensure that a fault such as OC does not occur during speed search operation, V/f must be reduced during speed search operation, as compared with that during normal operation. Set V/f during speed search as follows by the set value of No. 56:

$$V/f \text{ during speed search} = V/f \text{ at normal operation} \times \text{No. 56}$$

2-10-25 Output Voltage Limiter

Item name	Constant to be set	Factory preset
Output voltage limiter	No. 1	0000

The Inverter may malfunction if V/f is extremely large. To limit the output voltage in order to prevent the Inverter from malfunctioning, use the output voltage limiter function. In usual operation, however, it is not necessary to use this function.

No. 1 = 0xxx

- 0: With output voltage limiter
- 1: Without output voltage limiter

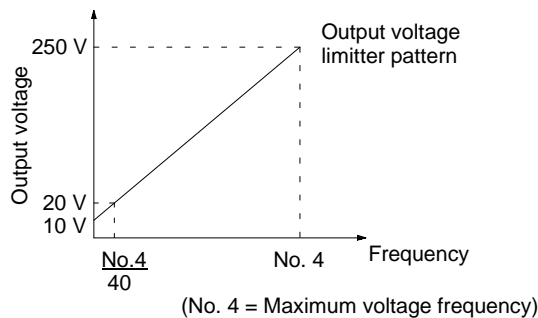

The output voltage will not exceed the upper limit if No. 1 is set to 0xxx.

2-11 Protection Function

Protection function		Explanation	Monitor display	Fault contact output
Low voltage protection	Main circuit voltage low	When the inverter power voltage drops, torque becomes insufficient and motor is overheated. Inverter output is stopped when the main circuit DC voltage becomes lower than the low voltage detection level for 15 ms or longer. Detection level: approximately 210 V or less (3-phase) approximately 170 V or less (single-phase)	uU1 (UV1)	Operation
Overcurrent protection		The inverter output is shut-off when the inverter output current becomes approx. 200% and above of inverter rated current.	%c (OC)	Operation
Ground-fault protection		The inverter output is shut-off when a ground-fault occurs at the inverter output side.	gf (GF)	Operation
Overvoltage protection		The inverter output is shut-off when the main circuit DC voltage becomes excessive because of regeneration energy caused by motor deceleration and negative load. Detection level: approx. 410 V or more	%U (OV)	Operation
Fuse blown		The inverter output is shut-off when the main circuit transistor fails. The fuse clears to prevent wiring from being damaged by the short-circuit current.	(Not displayed)	
Cooling fin overheat		The inverter output is shut-off when the ambient temperature rises and the heat sink fin reaches 90°C. Please check for a defective cooling fan or clogged filter.	%h (OH)	Operation
Overload protection	Motor	Inverter output is stopped when motor overload is detected by the electronic thermal overload in the inverter. Either a inverter duty constant-torque specialized motor or general-purpose motor can be selected. If more than one motor is drive, overload protection should be disabled. Use a thermal relay or thermal protector for each motor.	%l1 (OL1)	Operation
	Inverter	The inverter output is shut-off when electronic thermal overload reaches or exceeds the inverse time limit of 112% of the inverter's rated current occurs. Maximum rated overload: 150%, 1 min.	%l2 (OL2)	Operation
	Over torque detection	The motor operates according to a preset mode when the inverter output current exceeds the overtorque detection level. This function is used to protect the machine or to monitor the output torque.	%l3 (OL3)	Operation
External fault signal input		When an external alarm signal is input, the inverter operates according to a preset stop method (coasting to a stop, or ramp to stop)	ef3 (EF3)	Operation
Control circuit fault thermistor fault		The inverter output is shut-off when a transmission error occurs in the control circuit or a component fails.	cpf00 to cpf07* (see note) f04 f05 f07	Operation

Note * indicates the content of digital operator display

Protection function		Error causes	Action to be taken
Low voltage protection	Main circuit voltage low	Inverter capacity is too small. Voltage drop due to wiring. A motor of large capacity (11 kW or greater) connected to the same power system has been started. Rapid acceleration with generator power supply Operation sequence when power is off Defective electromagnetic contactor	Check the power capacity and power system. UV display appears when the inverter power is turned off while operation signal is input. Remove the power after stopping the inverter. (Set the third bit of constant 1 to 01.)
Overcurrent protection		Extremely rapid accel/decel Motor on/off switching at the inverter output side Short-circuit at the inverter output side Motor of a capacity greater than the inverter rating has been started. High-speed motor or pulse motor has been started.	Transistor error may occur. Investigate the error cause, correct it, then restart.
Ground-fault protection		Ground-fault at the inverter output side	
Overvoltage protection		Over voltage Insufficient deceleration time Regenerative load (Motor is turned by the load.) High input voltage compared to motor rated voltage	If braking torque is not proper, extend the decel time or use a braking resistor.
Fuse blown		Repeated overcurrent protection (OC) Repeated overload protection (OL2) power reset Rapid deceleration in excess excitation (improper V/f characteristic setting)	Turn off the power supply once and turn it on again. If the fault occurs again after replacement, replace the inverter.
Cooling fin overheat		Defective cooling fan Ambient temperature rise Clogged filter	Replace the cooling fan and clean the filter. Ambient temperature: 122°F (50°C) or less
Overload protection	Motor	Overload, low speed operation or extended acceleration time, improper V/f characteristic setting	Investigate the cause of overload and review the operation pattern, V/f characteristic, and motor/inverter capacities. (If inverter is repeatedly reset after an overload occurs, the inverter may fault. Investigate and correct the cause of overload.)
	Inverter		
	Over torque detection	Motor current exceeds the preset value because of machine error or overload	Check the use of the machine. Correct the overload cause or set a higher detection level which is within the allowable range.
External fault signal input		External fault condition occurred.	Correct the cause of the fault input.
Control circuit fault thermistor fault		External noise Excess vibration or shock	Record all data of f04 and cpf04, then make initialization. Turn off power, then turn on again. If error is persistent, replace the inverter.

2-12 Warning and Self-diagnosis Functions

Protection function		Explanation	Monitor display	Fault contact output
Low-voltage protection (main circuit voltage insufficient)		Monitor display appears when the main circuit DC voltage drops under the detection level while the inverter output is off.	(UV) uU (Blink)	Non operation
Overtorque detection		This function is used to protect the machine and to monitor the inverter's output torque. The inverter output reacts in a preset manner when the inverter output current exceeds the over torque detection level. The monitor display blinks when "operation continue" is preset.	(OL3) %13 (Blink)	Non operation
Stall prevention (Accel/decel is accomplished with maximum capacity of the inverter without tripping on overcurrent or overvoltage.)	During acceleration	Inverter acceleration is stopped when 170% of or more of the inverter rated current is required by the load. This prevents overload protection (OL2) or overcurrent (OC) from occurring. When current is reduced to less than 170%, acceleration is enabled.	---	Non operation
	During normal operation	Output frequency is decreased when 160% of the inverter rated current or greater is required by the load. This prevents motor and inverter overload (OL1, OL2). When current is reduced below 160%, inverter acceleration is then enabled.		
	During deceleration	Deceleration is stopped when the DC voltage is caused to rise by motor regenerative energy. This prevents overvoltage trips (OV). When DC voltage decreases, deceleration to the set value then resumes.		
Simultaneous normal and reverse rotation commands		When forward and reverse rotation commands are simultaneously detected for a period of time exceeding 500 ms, the inverter is stopped according to the preset stop method.	(EF) ef (Blink)	Non operation
External base block signal input (main circuit transistor instantaneous shut-off)		When an external base block signal is input, the motor coasts to a stop. When the external base block signal is removed, the inverter output is immediately turned on at the previously set frequency.	(BB) bb (Blink)	Non operation

Protection function		Error causes	Action to be taken
Low-voltage protection (main circuit voltage insufficient)		Input voltage drop	Check the main circuit DC voltage in Un-xx. If the voltage is low, adjust the input voltage.
Overtorque detection		Motor current exceeded the set value because of machine fault or overload.	Check the driven machine and correct the cause of the fault or set to a higher value.
Stall prevention (Accel/decel is accomplished with maximum capacity of the inverter without tripping on overcurrent or overvoltage.)	During acceleration	Insufficient power for accel/decel Overload Phase loss	Set proper accel/decel time for smooth operation. For stall prevention during normal operation lighten the load or increase inverter capacity.
	During normal operation		
	During deceleration		
Simultaneous normal and reverse rotation commands		Operation sequence error 3-wire/2-wire selection error	Recheck the control sequence. Recheck constant settings (No. 32 and No. 33).
External base block signal input (main circuit transistor instantaneous shut-off)		---	---

Revision History

A manual revision code appears as a suffix to the catalog number on the front cover of the manual.

Cat. No. I003-E1-1B

The following table outlines the changes made to the manual during each revision. Page numbers refer to the previous version.

Revision code	Date	Revised content
1	June 1992	Original production
1A	July 1992	<p>Page 16: "Power supply" rated input voltage and frequency data for "Single-phase" inverter model was changed.</p> <p>Page 17: S-curve characteristics and auto reset/restart operation were added to "Built-in function" of "Operation conditions".</p> <p>Page 19, 21: The terminal graphics have been replaced.</p> <p>Page 33: The digital operator display sequence was adjusted to conform to the rest of the sequences.</p> <p>Page 40: Page reference added for "S-curve at accel/decel time".</p> <p>Page 42: Page references added for "Momentary power loss protection" and "Auto reset/restart operation".</p> <p>Page 43: "Frequency jump control" and "Speed search control" added to the table. Page references for these functions were also added.</p> <p>Page 44: "No." was added to "Parameter Write Disable" and "Start/Stop Procedure" equations.</p> <p>Page 46: 200 mA was changed to 20 mA in the graph for "Output Frequency Control (Gain/Bias)".</p> <p>Page 53: Digit 3 was changed to Digit 1 in "Momentary Power Loss Protection".</p> <p>Page 54: "Cn-16" and "Cn-18" were changed to "No. 50" and No. 52" respectively in "Setting Prohibit Frequency Range (No. 50 to No. 53)".</p> <p>Page 55: "Set value = 7" and "Set value = 6" were changed to "Set value = 6" and "Set value = 7" respectively in "Speed Search Function". Graphic which follows was altered slightly. "Relay 1" of SEARCH command was changed to "Relay 2" in "Example of Sequence". "Cn-38" was changed to "No. 54" in "Speed Search Deactivation Current Level (No. 54)".</p> <p>Page 56: "Cn-41" was changed to "No. 55" in "V/f During Speed Search (No. 55)".</p> <p>Page 57: Detection level information for "Low voltage protection" was changed.</p>
1B	October 1992	<p>Page 38: "Output voltage limiter" row was added to the table. No. 49 was changed to No. 59 in the "Password" description 3.</p> <p>Page 43: The names and descriptions for No. 55 and No. 56 were switched in the table. No. 49 was changed to No. 59 at the bottom of the page.</p> <p>Page 45: An additional note has been added.</p> <p>Page 54: Nos. 50 and 52 were switched in the graph. The \leq symbols were replaced with \geq in Note 2. The item names and factory presets were switched for Nos. 55 and 56 in the table.</p> <p>Page 55: No. 56 has been changed to No. 55 in "Minimum Baseblock Time".</p> <p>Page 56: No. 55 has been changed to No. 56 in "V/f During Speed Search". The section <i>2-10-25 Output Voltage Limiter</i> has been added.</p>