

# **ES1A**

# **Non-contact Temperature Sensor**

## **Operation Manual**

*Produced January 1999*

## **Notice:**

OMRON products are manufactured for use according to proper procedures by a qualified operator and only for the purposes described in this manual.

The following conventions are used to indicate and classify precautions in this manual. Always heed the information provided with them. Failure to heed precautions can result in injury to people or damage to property.

 **DANGER** Indicates an imminently hazardous situation which, if not avoided, will result in death or serious injury.

 **WARNING** Indicates a potentially hazardous situation which, if not avoided, could result in death or serious injury.

 **Caution** Indicates a potentially hazardous situation which, if not avoided, may result in minor or moderate injury, or property damage.

## **OMRON Product References**

All OMRON products are capitalized in this manual. The word “Unit” is also capitalized when it refers to an OMRON product, regardless of whether or not it appears in the proper name of the product.

The abbreviation “Ch,” which appears in some displays and on some OMRON products, often means “word” and is abbreviated “Wd” in documentation in this sense.

The abbreviation “PC” means Programmable Controller and is not used as an abbreviation for anything else.

## **Visual Aids**

The following headings appear in the left column of the manual to help you locate different types of information.

**Note** Indicates information of particular interest for efficient and convenient operation of the product.

**1, 2, 3...** 1. Indicates lists of one sort or another, such as procedures, checklists, etc.

## **© OMRON, 1999**

All rights reserved. No part of this publication may be reproduced, stored in a retrieval system, or transmitted, in any form, or by any means, mechanical, electronic, photocopying, recording, or otherwise, without the prior written permission of OMRON.

No patent liability is assumed with respect to the use of the information contained herein. Moreover, because OMRON is constantly striving to improve its high-quality products, the information contained in this manual is subject to change without notice. Every precaution has been taken in the preparation of this manual. Nevertheless, OMRON assumes no responsibility for errors or omissions. Neither is any liability assumed for damages resulting from the use of the information contained in this publication.

# TABLE OF CONTENTS

<b>PRECAUTIONS</b> .....	
1 Intended Audience .....	
2 General Precautions .....	
3 Operating Environment Precautions .....	
4 Application Precautions .....	
<b>SECTION 1</b>	
<b>Features and Ordering Information</b> .....	
1-1 Features .....	
1-2 Ordering Information .....	
<b>SECTION 2</b>	
<b>Dimensions</b> .....	
2-1 ES1A-A .....	
2-2 ES1A-B .....	
2-3 ES1A-C .....	
2-4 ES1A-J .....	
<b>SECTION 3</b>	
<b>Specifications</b> .....	
3-1 Ratings .....	
3-2 Field-of-vision .....	
3-3 Accuracy .....	
<b>SECTION 4</b>	
<b>Operation Principle</b> .....	
4-1 Operation Principle .....	
4-2 Causes of Errors .....	
<b>SECTION 5</b>	
<b>Input Shift for Temperature Controller</b> .....	
5-1 Connection to E5CN or E5GN .....	
5-2 Connection to Temperature Controller other than E5CN and E5GN .....	
<b>SECTION 6</b>	
<b>Mounting and Wiring</b> .....	
6-1 Mounting .....	
6-2 Connections .....	
6-3 Adjustments .....	
6-4 Cleaning .....	
6-5 Mounting the ES1A-J .....	
<b>SECTION 7</b>	
<b>Application Examples</b> .....	
7-1 Detection of Workpieces Conveyed Intermittently .....	
7-2 Continuous Furnace (Thermal Treatment of Sheets) .....	
7-3 Air Purge .....	
7-4 Monitoring Hot-melt Adhesive Application .....	
<b>SECTION 8</b>	
<b>Troubleshooting</b> .....	
<b>Appendix</b>	
Radiation Rates .....	
<b>Revision History</b> .....	

## ***About this Manual:***

This manual describes the installation and operation of the ES1A Non-contact Temperature Sensor and includes the sections described below.

Please read this manual carefully and be sure you understand the information provided before attempting to install and operate the ES1A Non-contact Temperature Sensor.

**Section 1** provides the features of the ES1A and a list of available models.

**Section 2** provides the dimensions for all ES1A models.

**Section 3** provides the ratings, field-of-view characteristics, and accuracy of the ES1A.

**Section 4** provides the ES1A operation principle and causes of errors.

**Section 5** provides details on the input shift in relation with various Temperature Controllers.

**Section 6** provides installation procedures and precautions.

**Section 7** provides various application examples.

**Section 8** provides probable causes and remedies of ES1A errors.

The appendix provides radiation rates of various materials.



### **WARNING**

Failure to read and understand the information provided in this manual may result in personal injury or death, damage to the product, or product failure. Please read each section in its entirety and be sure you understand the information provided in the section and related sections before attempting any of the procedures or operations given.

# PRECAUTIONS

This section provides general precautions for using the ES1A Non-contact Temperature Sensor and related devices.

**The information contained in this section is important for the safe and reliable application of the ES1A Non-contact Temperature Sensor. You must read this section and understand the information contained before attempting to set up or operate the ES1A Non-contact Temperature Sensor.**

## 1 Intended Audience

This manual is intended for the following personnel, who must also have knowledge of electrical systems (an electrical engineer or the equivalent).

- Personnel in charge of installing factory automation systems.
- Personnel in charge of designing factory automation systems.
- Personnel in charge of managing factory automation systems and facilities.

## 2 General Precautions

The user must operate the product according to the performance specifications described in the operation manuals.

Before using the product under conditions which are not described in the manual or applying the product to nuclear control systems, railroad systems, aviation systems, vehicles, combustion systems, medical equipment, amusement machines, safety equipment, and other systems, machines, and equipment that may have a serious influence on lives and property if used improperly, consult your OMRON representative.

Make sure that the ratings and performance characteristics of the product are sufficient for the systems, machines, and equipment, and be sure to provide the systems, machines, and equipment with double safety mechanisms.

This manual provides information for programming and operating the Unit. Be sure to read this manual before attempting to use the Unit and keep this manual close at hand for reference during operation.

 **WARNING** It is extremely important that the ES1A Non-contact Temperature Sensor be used for the specified purpose and under the specified conditions, especially in applications that can directly or indirectly affect human life. You must consult with your OMRON representative before applying the ES1A Non-contact Temperature Sensor to the above-mentioned applications.

## 3 Operating Environment Precautions

 **Caution** Do not operate the ES1A Non-contact Temperature Sensor in the following locations:

- Locations subject to dust or corrosive gases (particularly, sulfide gases, ammonia gases).
- Locations subject to condensation or icing.
- Locations subject to shock or vibration.
- Locations subject to exposure to oil, chemicals, cosmetics, detergents, or adhesives.
- Locations subject to radical temperature changes.

## 4 Application Precautions

Observe the following precautions when using the ES1A Non-contact Temperature Sensor.

**Caution**

Failure to abide by the following precautions could lead to faulty operation of the ES1A Non-contact Temperature Sensor, or could damage the Sensor. Always heed these precautions.

- Pay careful attention to the environmental conditions so that the operating temperature of the ES1A Non-contact Temperature Sensor will not exceed the upper limit. When using the ES1A-C Non-contact Temperature Sensor, the operating temperature should not exceed the upper limit regardless of whether or not the Sensor is provided with air-cooling measures.
- Check terminal polarities and wire correctly. (The red lead wire must be connected to the negative side.)
- Be sure to ground the shielded cables.
- Separate the wiring from high-voltage or high-current lines to prevent the influence of inductive noise. Avoid wiring in the same conduits as or in parallel with power lines.

# SECTION 1

## Features and Ordering Information

This section provides the features of the ES1A and a list of available models.

- 1-1 Features .....
- 1-2 Ordering Information .....

## 1-1 Features

**No Power Supply Required**

The ES1A has electromotive output as high as that of a thermocouple, thus connecting directly to the thermocouple input terminal of the Temperature Controller with no external power supply required.

**Compact**

The ES1A-A is as compact as 14 x 18.6 x 34 (W x H x D) and can be built into machines and equipment with ease.

**Low Price**

The ES1A costs less than any of OMRON's conventional Non-contact Temperature Sensor models. Furthermore, the ES1A is highly durable, thus requiring replacement less frequently than thermocouples while ensuring economical operating cost.

**Available at High Ambient Temperature**

The ES1A-C has a measurement temperature range between 115°C and 165°C or 160°C and 260°C and incorporates an air purge function, thus air-cooling itself and operating at a maximum of 120°C.

**Four Temperature Ranges (10°C to 260°C) Selectable**

Four temperature ranges are available to cover a wide range of temperature measurement needs including those in the food processing, packaging, molding, and electronic industries.

**High-speed Response and High Precision**

High-precision temperature measurement is ensured by a high-speed response of 300 ms, provided that the response rate is 63.2%, and an indicator reproducibility of ±0.1%. Unlike thermocouples, the Sensor does not deteriorate. Therefore, stable, real-time temperature control can be maintained.

## 1-2 Ordering Information

The following models are available.

Model	Temperature range			
	10°C to 70°C	60°C to 120°C	115°C to 165°C	160°C to 260°C
ES1A-A	Yes	Yes	Yes	---
ES1A-B	Yes	Yes	Yes	Yes
ES1A-C	Yes	Yes	Yes	Yes
ES1A-J	Cooling Jacket for ES1A-C			



## **SECTION 2**

### **Dimensions**

This section provides the dimensions for all ES1A models.

2-1	ES1A-A	.....
2-2	ES1A-B	.....
2-3	ES1A-C	.....
2-4	ES1A-J	.....

## 2-1 ES1A-A

Unit: mm

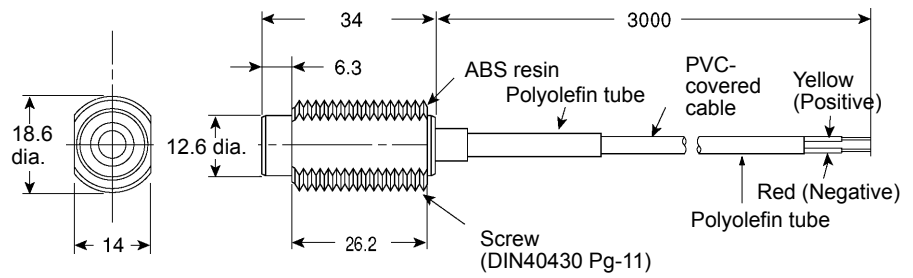

### Mounting Lock Nuts (Two)

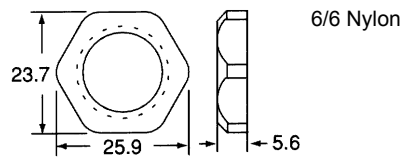

## 2-2 ES1A-B

Unit: mm

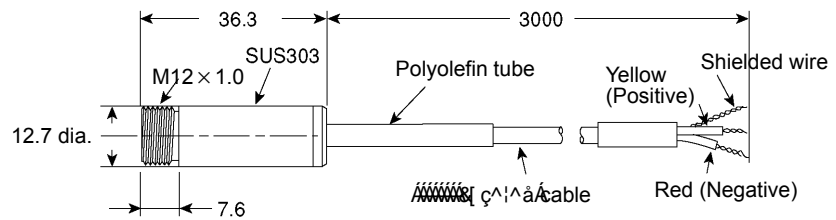

### Mounting Bracket (One)

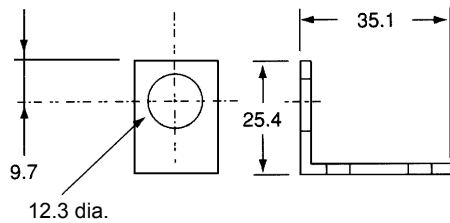

### Panel Nuts (Two)

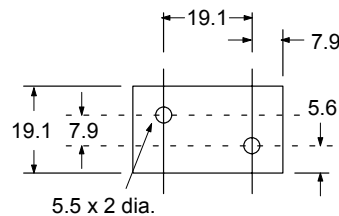
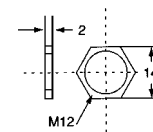

t=1.6 SUS304

### 2-3 ES1A-C

Unit: mm

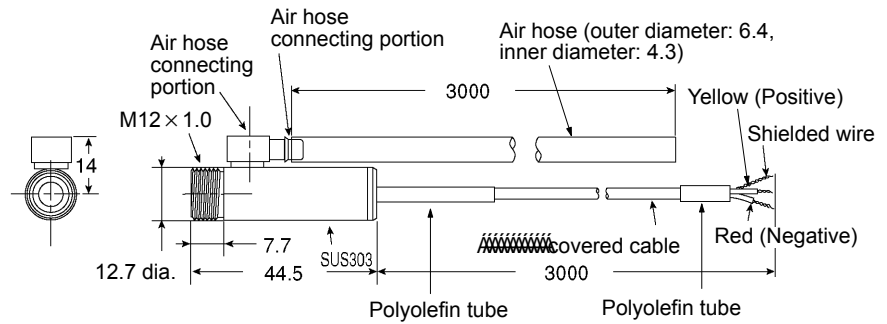

Mounting Bracket (One)

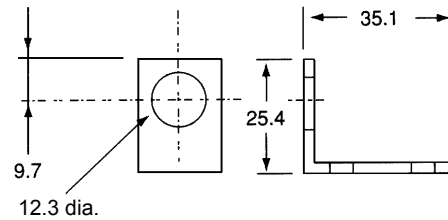

Panel Nuts (Two)

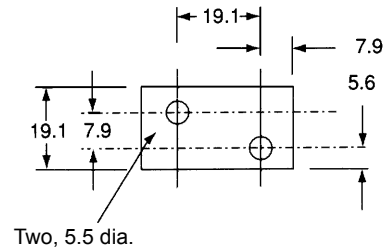
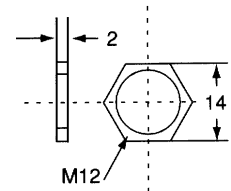

t=1.6 SUS304

### 2-4 ES1A-J

Unit: mm

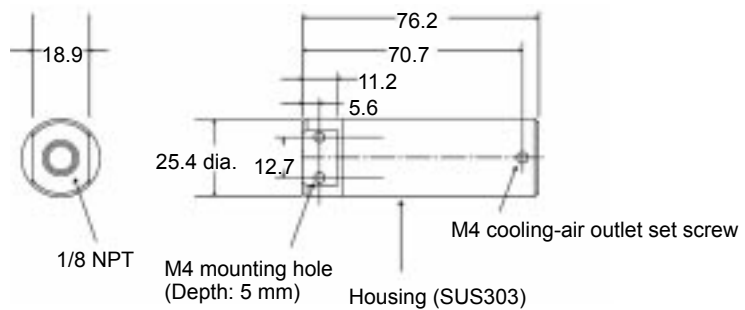

# SECTION 3

## Specifications

This section provides the ratings, field-of-view characteristics, and accuracy of the ES1A.

3-1	Ratings .....
3-2	Field-of-vision .....
3-3	Accuracy .....

### 3-1 Ratings

Item		ES1A-A	ES1A-B	ES1A-C
Temperature range		10°C to 70°C, 60°C to 120°C, 115°C to 165°C	10°C to 70°C, 60°C to 120°C, 115°C to 165°C, 160°C to 260°C	
Precision (Based on characteristics of K-type thermocouple and radiation rate of 0.9)	Temperature change from reference temperature of sensing objects ±5°C ±10°C ±30°C ±40°C	±2% PV or ±2°C, whichever is larger. ±4% PV or ±4°C, whichever is larger. ±6% PV or ±6°C, whichever is larger. ±8% PV or ±8°C, whichever is larger.		
Reproducibility		±1% PV or ±1°C, whichever is larger.		
Temperature drift		0.4°C/°C max.		
Sensing distance vs. sensing diameter		1:1 typ.	2:1 typ.	
Measurement wavelength		6.5 to 14.0 μm		
Receiver element		Thermopile		
Response speed		Approximately 300 ms at response rate of 63%		
Output impedance		1 to 4 kΩ	3 to 10 kΩ	
Ambient operating temperature		-25°C to 70°C (with no icing or condensation)	10°C to 70°C, 60°C to 120°C models: -25°C to 85°C 115°C to 165°C, 160°C to 260°C models: -25°C to 100°C	With no icing or condensation At 120°C max. in air purge operation and 250°C max. with the Cooling Jacket used, provided that there is no icing or condensation
Ambient humidity		Operating: 35% to 85%		
Vibration resistance		100 m/s <sup>2</sup> for 2 hours each in X, Y, and Z directions at 10 to 55 Hz		
Shock resistance		300 m/s <sup>2</sup> for 3 times each in X, Y, and Z directions.		
Casing material		Hard ABS resin	SUS303	
Degree of protection		IP65	IP60	
Weight		55 g	65 g	70 g
Cable		Compensating conductor: 3 m PVC-covered cable resisting 70°C.	Thermocouple cable: 3 m Covered cable with a shielded wire resisting 180°C.	

### 3-2 Field-of-vision

Each of the following field-of-vision spots detects 50% of energy emitted from the sensing object. The actual sensing object must be 1.5 times larger than the spot.

ES1A-A, ES1A-B

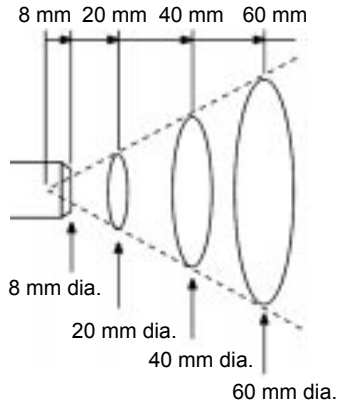

ES1A-C

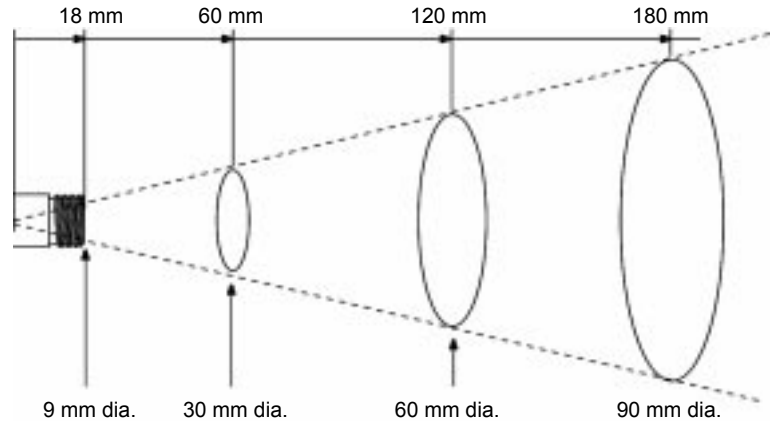

### 3-3 Accuracy

The accuracy of the ES1A is expressed by the fluctuation (D) of the ES1A's output voltage based on the characteristic (C) of the K-type thermocouple, provided that the fluctuation (D) is caused by the temperature (B) deviation of the reference temperature (A). The reference temperature (A) is obtained after compensating the PV error that results when the ES1A is connected to the Temperature Controller.

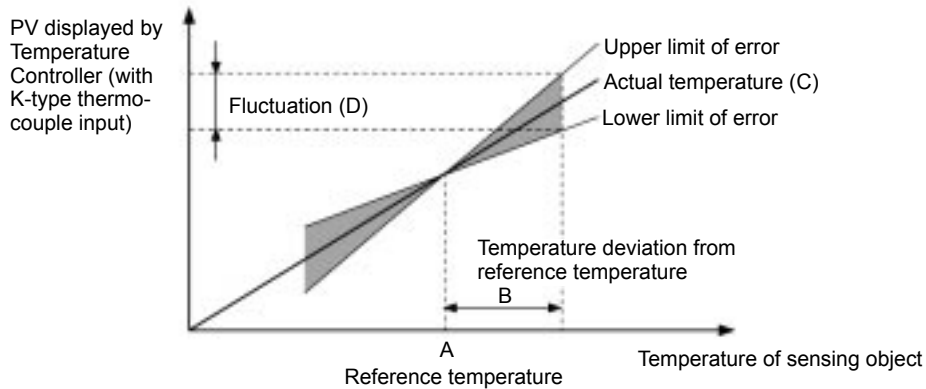

# SECTION 4

## Operation Principle

This section provides the ES1A operation principle and causes of errors.

- 4-1 Operation Principle .....
- 4-2 Causes of Errors .....
- 4-2-1 Impedance .....
- 4-2-2 Radiation Rate .....
- 4-2-3 Error Factors .....

## 4-1 Operation Principle

The thermopile of the ES1A receives infrared rays within a wavelength range between 6.5 and 14  $\mu\text{m}$  that is a part of thermal energy radiated from the sensing object and the thermopile converts the infrared rays into voltage output. In order to use this voltage output in place of K-type thermocouple output, the voltage output is compensated so that it will be almost linear and as close as possible to the output of the K-type thermocouple.

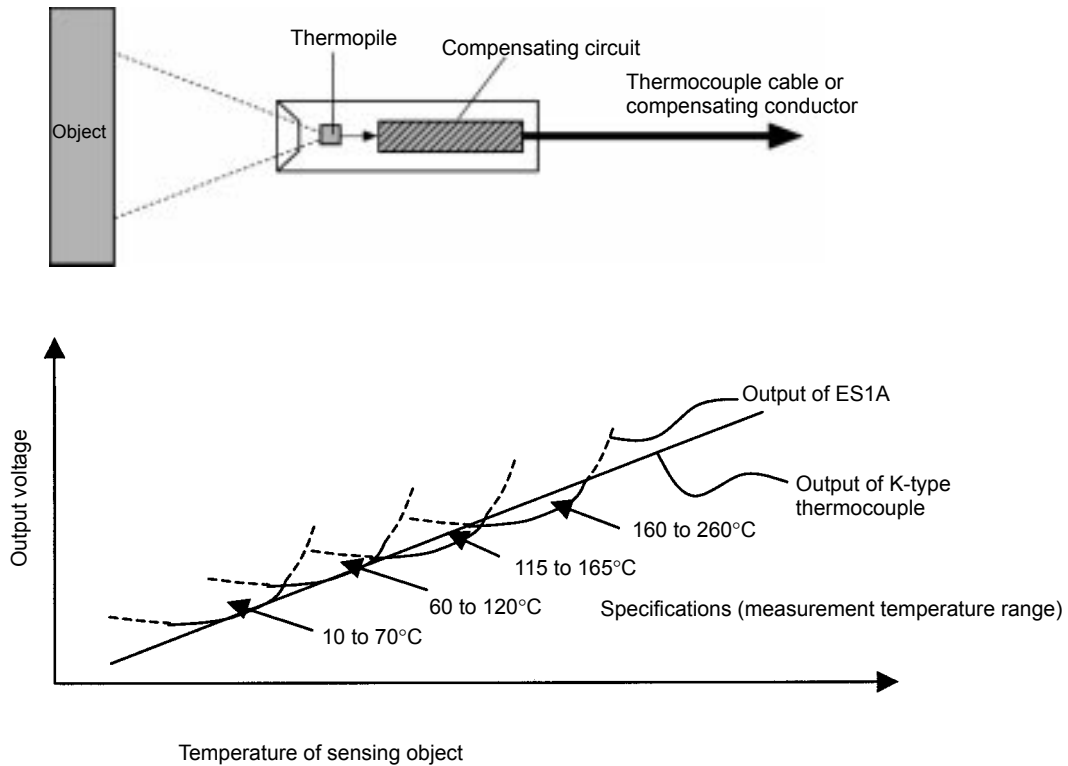

## 4-2 Causes of Errors

### 4-2-1 Impedance

The output impedance of the ES1A is 1 to 10  $\text{k}\Omega$ . Usually, the Temperature Controller has a burnout-detecting current. Therefore, an offset of several degrees to several tens of degrees Celsius will result.

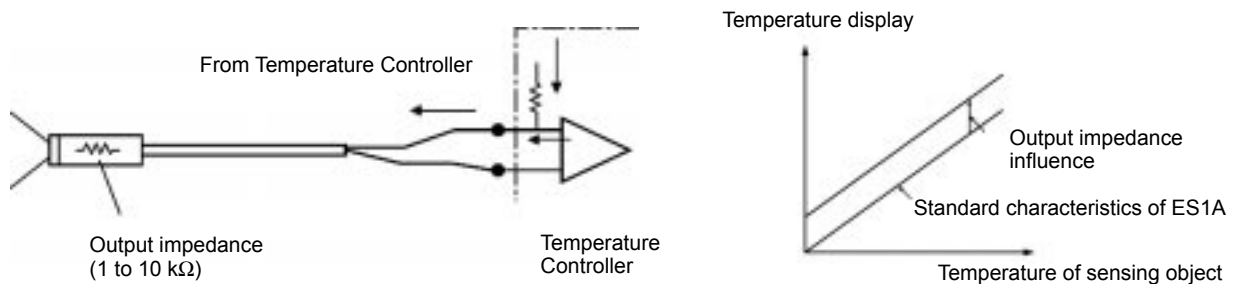



### 4-2-2 Radiation Rate

If the sensing object's radiation rate  $\epsilon$  is less than 0.9, the ambient temperature will affect the Sensor. The radiation rate of a metal surface is generally very low. Therefore, it is difficult to measure the temperature.

#### Relationship between Radiation and Reflection Rates

The sensing object radiates and reflects heat (i.e., infrared rays). Its material and surface conditions determine the infrared radiation and reflection rates of the sensing object. The total of these rates is always constant.

$$\epsilon \text{ (radiation rate)} + \rho \text{ (reflection rate)} = 1$$

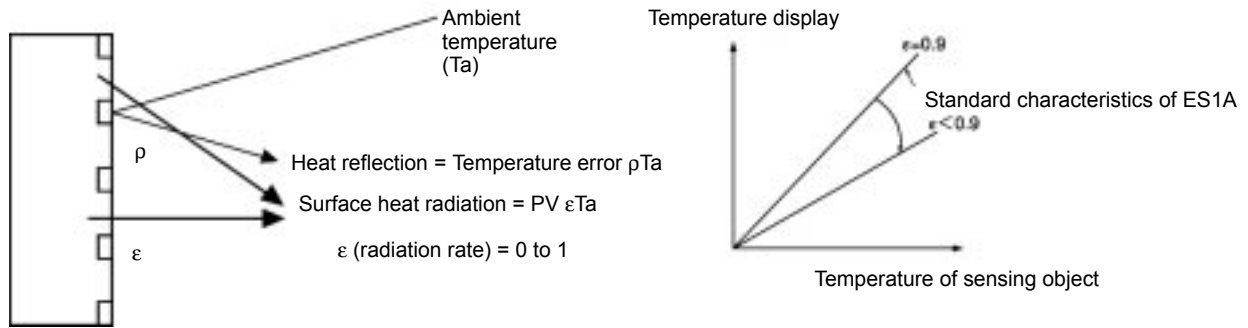

### 4-2-3 Error Factors

The actual output voltage of the ES1A is affected by the compound influence of the above impedance and nonconformity of the radiation rate.

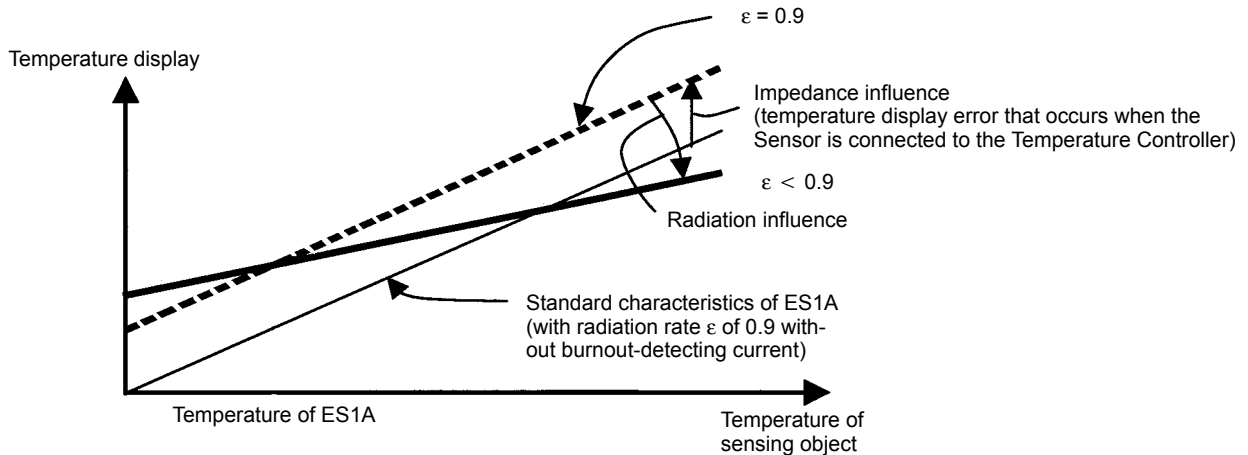

# SECTION 5

## Input Shift for Temperature Controller

This section provides details on the input shift in relation with various Temperature Controllers.

- 5-1 Connection to E5CN or E5GN .....
- 5-1-1 Input Shift .....
- 5-1-2 Input Shift Value Calculation (Two-point Shift) .....
- 5-2 Connection to Temperature Controller other than E5CN and E5GN .....
- 5-2-1 Two-point Shift (Connection to E5AK, E5CK, or E5CK) .....
- 5-2-2 One-point Shift  
        (Connection to Temperature Controller with Input Shift Function) .....

## 5-1 Connection to E5CN or E5GN

### 5-1-1 Input Shift

The input shift type is displayed according to the input type of Sensor selected.

- Two-point shift compensation is used for the Non-contact Temperature Sensor only.
- The input temperature range is shifted by the temperature input shift value. For example, a display value of 200°C is shifted to 201.2°C if the shift value is 1.2°C.

#### Two-point Shift



Upper-limit temperature input shift value



Lower-limit temperature input shift value

- Set the input type to Non-contact Temperature Sensor (12 through 15).
- The input temperature range of Non-contact Temperature Sensors can be shifted by setting an individual value for the upper and lower points of the sensor range. This means that the shift can be applied equally across the range with separate values for each end of the range. For example, if the upper-limit value is set to “2°C” and the lower-limit value is set to “1°C,” the sensor range will be shifted by an average of 1.5°C at 50% input.
- Set the upper-limit value in the “upper-limit temperature input shift value” parameter and the lower-limit value in the “lower-limit temperature input shift value” parameter.

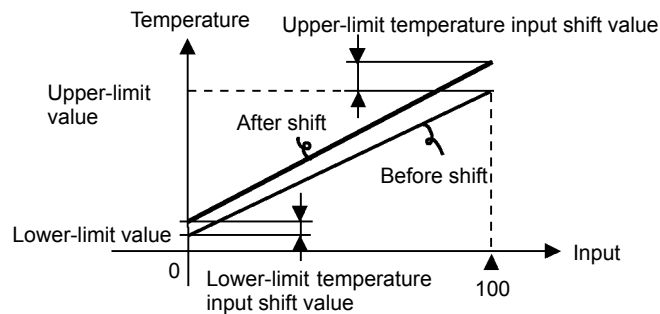

### 5-1-2 Input Shift Value Calculation (Two-point Shift)

When the ES1A Non-contact Temperature Sensor is connected to the E5CN or E5GN, an offset of several to several tens of a degree can occur.

For this reason, offset the display value by a one-point or two-point shift as described in this section. This offset occurs as a bias current for detecting controller sensor error flows to the output impedance of the Non-contact Temperature Sensor. Two-point shift can be carried out only on Non-contact Temperature Sensors and cannot be set for other input types.

#### Preparations

- 1, 2, 3... 1. Set to the temperature range matching the input specifications of the Non-contact Temperature Sensor. (ES1A is supported only on thermocouple input models of the E5CN or E5GN.)

2. Prepare a thermometer capable of measuring the temperature of the control target as shown in Figure 1 so that a one-point or two-point shift can be carried out.

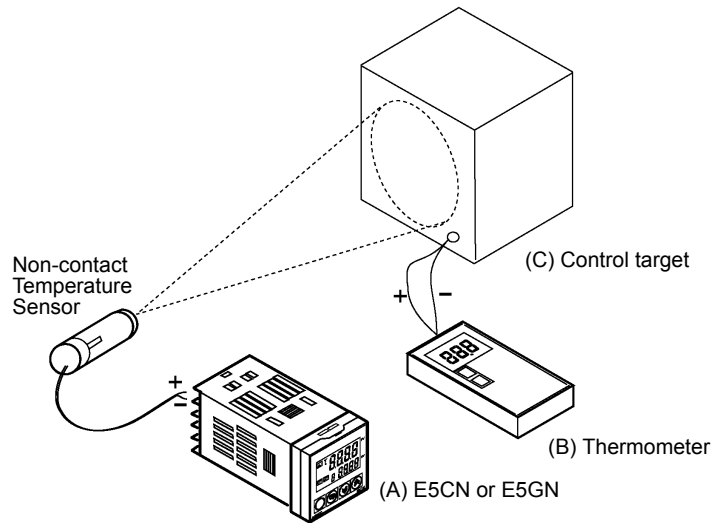
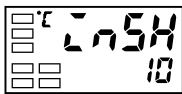

Figure 1: Configuration When Compensating a Non-contact Temperature Sensor

### One-point Shift Method

1, 2, 3...

Adjustment level



Upper-limit temperature input shift value

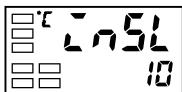

Lower-limit temperature input shift value

1. In the configuration shown in Figure 1, bring the set point close to the value at which the temperature of the control target is to be controlled. Assume that the control target temperature (C) and the control target temperature (B) match.
2. Check the control target temperature (B) and the Controller display value (A). Take the following value as the input shift value and set the same numerical values to 27.52 and 27.54.

$$\text{control target temperature (B) - controller display value (A)}$$

Figure 2 shows the effect of one-point temperature input shift.

3. After the input shift values have been set, check Controller display value (A) and control target temperature (B). If they are almost the same, this means that the temperature input shift is complete.

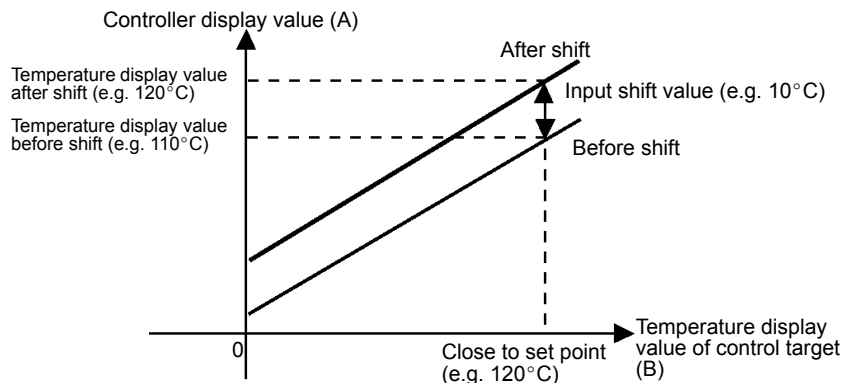
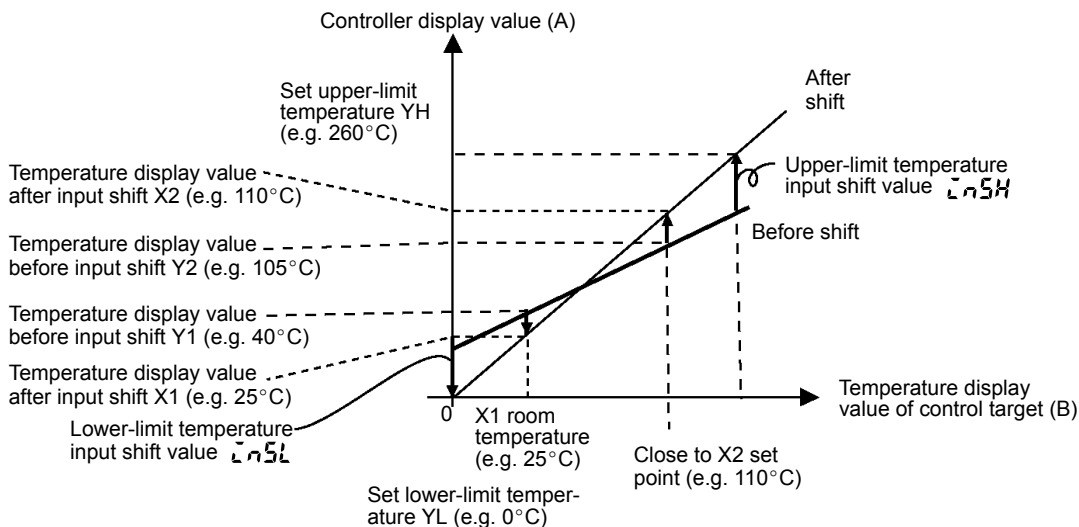

Figure 2: One-point Temperature Input Shift

**Two-point Shift Method**

Use two-point input shift to increase the accuracy of the display values across the range of the Sensor.

- 1, 2, 3... 1. Shift the Controller display value by two points, close to the room temperature and close to the value at which the temperature of the control target is to be controlled. For this reason, bring the control target temperature close to the room temperature and close to the set point, and check the control target temperature (B) and Controller display value (A).
2. Using equations (1) and (2), calculate the upper- and lower-limit temperature input shift values from the display value and temperature to be shifted that was obtained in step 1. Figure 3 shows the effect of a two-point temperature input shift.



**Figure 3: Two-point Temperature Input Shift**

- Use the following equation to calculate the lower-limit temperature input shift value.

$$\Delta X_{L} = \frac{Y_L - Y_1}{Y_2 - Y_1} \times \{(X_2 - Y_2) - (X_1 - Y_1)\} + (X_1 - Y_1) \dots \text{equation 1}$$

- Use the following equation to calculate the upper-limit temperature input shift value.

$$\Delta X_{H} = \frac{Y_H - Y_1}{Y_2 - Y_1} \times \{(X_2 - Y_2) - (X_1 - Y_1)\} + (X_1 - Y_1) \dots \text{equation 2}$$

3. After the calculated values have been set to “ $\Delta X_{L}$ ” and “ $\Delta X_{H}$ ,” check Controller display value (A) and control target temperature (B).
4. Although the input shift was carried out at two points, close to room temperature (ambient temperature) and close to the set point, select points close to each end of the Sensor range to improve accuracy across the full range of the Sensor measurement range.

**Note** Before selecting these values, check that they will not damage the Controller when applied.

**Example of Two-point Temperature Input Shift**

In this example, the ES1A is used in the 160°C to 260°C specification.

In equations 1 and 2, the set lower-limit temperature YL is 0°C and set upper-limit temperature YH is 260°C. Check the temperature of the control target.

When the room temperature X1 is 25°C, the display value on Controller Y1 will be 40°C, and when the temperature close to the set point X2 is 110°C, the display value on Controller Y2 will be 105°C.

Adjustment level

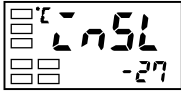

Lower-limit temperature input shift value

Lower-limit temperature input shift value

$$\bar{L}n5L = \frac{0 - 40}{105 - 40} \times \{(110 - 105) - (25 - 40)\} + (25 - 40) = -27.3(^{\circ}\text{C})$$

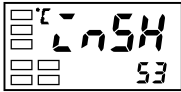

Upper-limit temperature input shift value

Upper-limit temperature input shift value

$$\bar{L}n5H = \frac{260 - 40}{105 - 40} \times \{(110 - 105) - (25 - 40)\} + (25 - 40) = 52.7(^{\circ}\text{C})$$

**5-2 Connection to Temperature Controller other than E5CN and E5GN**

**5-2-1 Two-point Shift (Connection to E5AK, E5CK, or E5CK)**

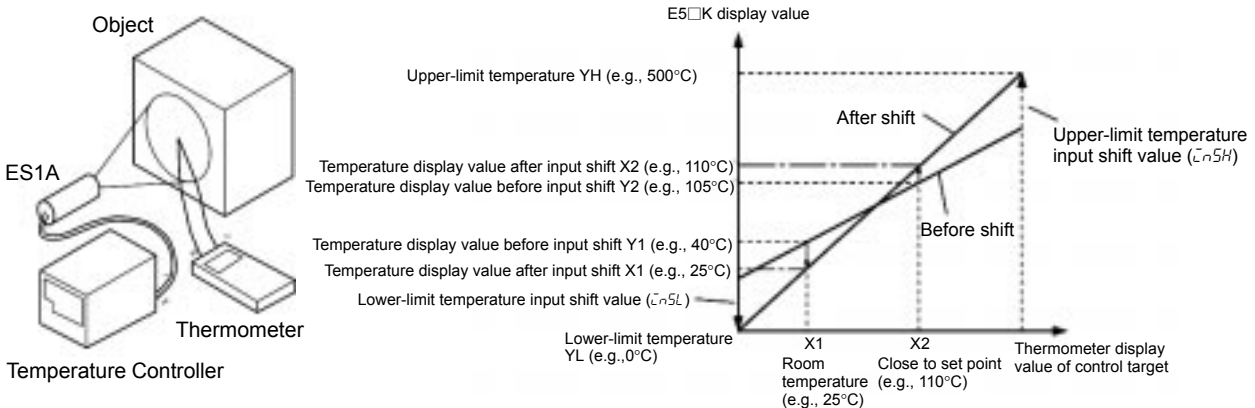

- 1, 2, 3...**
- Shift the Controller display value by two points, close to room temperature and close to the value at which the temperature of the control target is to be controlled. For this reason, bring the control target temperature close to room temperature and close to the set point, and check the thermometer reading and the display value of the E5□K at each of these temperature points. If greater temperature measurement accuracy in the sensing range is required, check the thermometer reading and the display value of the E5□K at a point in the sensing range instead of room temperature.
  - Use the following equations to calculate the upper- and lower-limit temperature input shift values.

- Lower-limit temperature input shift value

$$\bar{L}n5L = \frac{YL - Y1}{Y2 - Y1} \{(X2 - Y2) - (X1 - Y1)\} + (X1 - Y1)$$

- Upper-limit temperature input shift value

$$\bar{L}n5H = \frac{YH - Y1}{Y2 - Y1} \{(X2 - Y2) - (X1 - Y1)\} + (X1 - Y1)$$

Example: K2 is selected as the input type.

Lower-limit temperature YL = 0°C

Upper-limit temperature YH = 500°C

Room temperature X1 = 25°C

Temperature display value of Temperature Controller Y1 = 40°C

Temperature close to set point X2 = 110°C

Temperature display value of Temperature Controller Y2 = 105°C

Lower-limit temperature input shift value

$$\tilde{I}nSl = \frac{0 - 40}{105 - 40} \times \{(110 - 105) - (25 - 40)\} + (25 - 40) = -27.3(^{\circ}C)$$

Upper-limit temperature input shift value

$$\tilde{I}nSh = \frac{500 - 40}{105 - 40} \times \{(110 - 105) - (25 - 40)\} + (25 - 40) = 126.5(^{\circ}C)$$

### 5-2-2 One-point Shift (Connection to Temperature Controller with Input Shift Function)

- 1, 2, 3...
1. Check the control target temperature and the display value of the Temperature Controller when the temperature of the object is close to the set point.
  2. Input the control target temperature minus the display value of the Temperature Controller as an input shift into the Temperature Controller.
  3. If the Temperature Controller is the E5AK, E5EK, or E5CK, make sure that the upper-limit temperature shift value is the same as the lower-limit temperature input shift value.

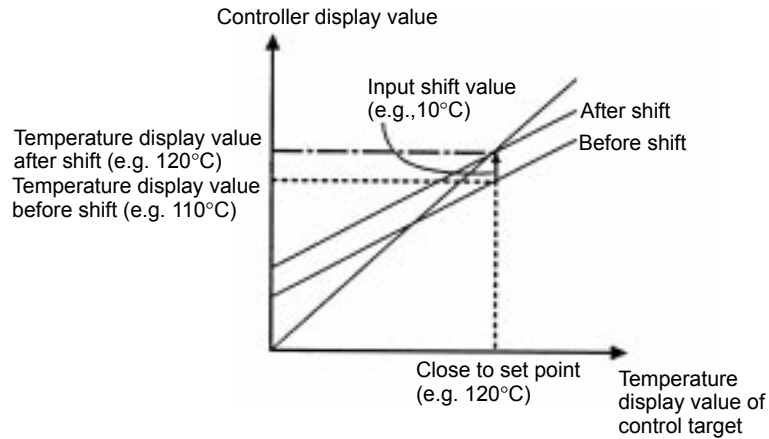
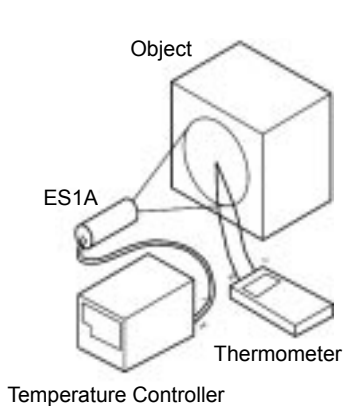

# SECTION 6

## Mounting and Wiring

This section provides installation procedures and precautions.

- 6-1 Mounting .....
- 6-1-1 Precautions .....
- 6-1-2 Field-of-vision Range .....
- 6-2 Connections .....
- 6-3 Adjustments .....
- 6-4 Cleaning .....
- 6-5 Mounting the ES1A-J .....



## 6-1 Mounting

### 6-1-1 Precautions

- Make sure that the radiation rate of the sensing object is as close as possible to 0.9. If the radiation rate is low, use black spray or black tape.
- The tip of the ES1A must be as close as possible to the sensing object.
- Make sure that the temperature of the ES1A itself does not exceed the ambient operating temperature range specified.
- Make sure that the temperature of the ES1A-C itself is within the range specified for the ES1A-C in operation without air-cooling, regardless of whether the ES1A-C in actual operation is provided with air-cooling or not. If necessary, connect an air hose and perform an air purge. To change the direction of the air hose joint, loosen the set screw of the air hose joint. If the ES1A-C is used at higher temperature, use the ES1A-J Cooling Jacket.
- The air hose withstands a maximum temperature of 75°C. If the ambient temperature exceeds 75°C, always provide air-cooling.
- Make sure that the filter is clear and free of dirt or dust. When using the ES1A-C, perform an air purge if necessary.
- Secure the ES1A-A with the lock nuts provided. Make sure that each nut is tightened to a maximum torque of 0.5 N • m.
- Secure the ES1A-B and ES1A-C with the panel nuts provided.

### 6-1-2 Field-of-vision Range

The field-of-vision spot detects 50% of the energy emitted from the sensing object. The actual sensing object must be 1.5 times larger than the spot in order to suppress the influence of an external temperature disturbance that may exist around the sensing object. If the sensing object is, however, not 1.5 times larger than the spot, the Temperature Controller with a proper input shift setting will still eliminate this temperature influence as long as there is a correlation between the temperature of the sensing object and ambient temperature.

If part B as shown below is always 70°C when the temperature of part A of the sensing object is 100°C, perform an input shift setting for 100°C to cancel the temperature influence of part B.

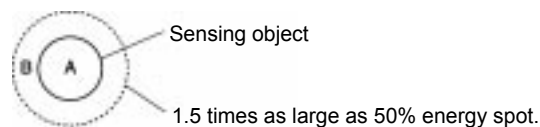

## 6-2 Connections

Connect the yellow lead wire to the positive side and the red lead wire to the negative side.

These lead wire colors conform to ANSI standards.

If the lead wires need to be extended, connect them to compensating cables for the K-type thermocouple.

Be sure to ground the shield.

Do not bend the lead wires repeatedly.

**Two-point Grounding (ES1A-B and ES1A-C Only)**

Be sure to ground the shield in order to prevent the ES1A from destruction that may be caused by static electricity. If the output of the ES1A fluctuates, the shield and the stainless steel housing of the ES1A is probably grounded at two points and current feedback may be resulting. If that happens, insulate the stainless steel housing.



**6-3 Adjustments**

Refer to *Section 5 Input Shift for Temperature Controller* and perform proper adjustments of the Temperature Controller.

**6-4 Cleaning**

Do not use any organic solvent, such as paint thinner, to clean the Sensor. Apply alcohol.

**6-5 Mounting the ES1A-J**

- 1, 2, 3...
1. Loosen the set screw of the air hose joint of the ES1A-C and disconnect the air hose joint. Use a cutter knife and remove the heat-shrink tube on the lead wires (part A in the illustration below).
  2. Loosen the screws on the ES1A-J and insert the lead wires into the spring. Then insert the lead wires with the spring into the ES1A-C.
  3. Attach the male connector, 1/4-inch pipe, T-type bifurcated connector, and male connector with a nylon insert to the ES1A-J in this order so that the lead wires will pass through the center of each of these components.
  4. Use the set screw to adjust the direction in which the air blows.

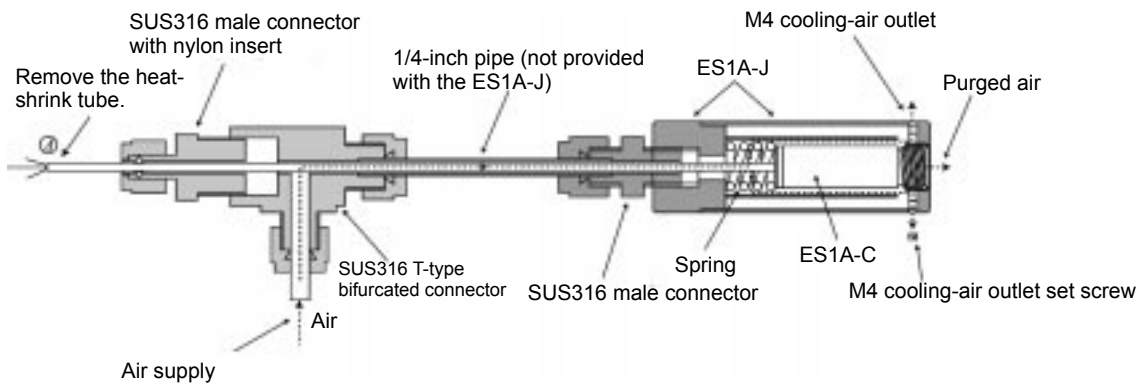

# SECTION 7

## Application Examples

This section provides various application examples.

7-1	Detection of Workpieces Conveyed Intermittently .....
7-1-1	Example with ES100X/P .....
7-1-2	Example with K3NH .....
7-2	Continuous Furnace (Thermal Treatment of Sheets) .....
7-3	Air Purge .....
7-4	Monitoring Hot-melt Adhesive Application .....
7-4-1	Example with E5_N .....

## 7-1 Detection of Workpieces Conveyed Intermittently

### 7-1-1 Example with ES100X/P

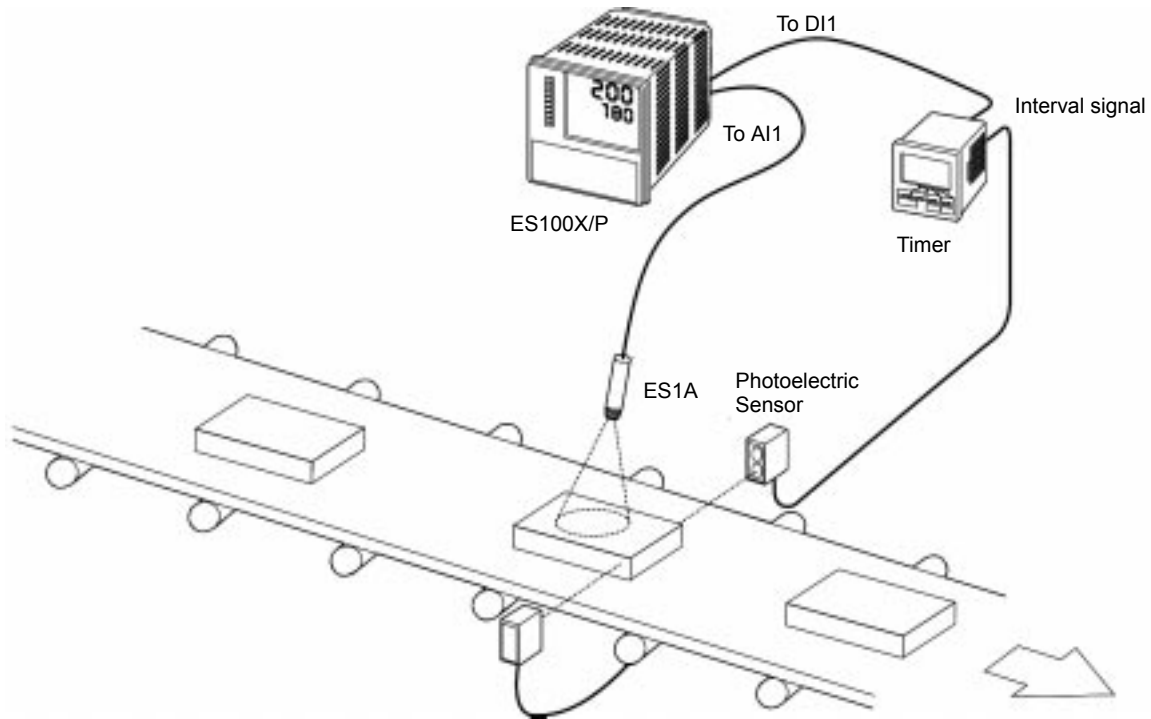

When the Photoelectric Sensor detects the workpiece, the Photoelectric Sensor will transmit a signal to the timer. The timer receives the signal and transmits an interval signal to DI1 of the ES100X/P. Temperature input from the ES1A is enabled for a period set in the timer after the signal is turned ON.

**Note** Set the temperature input timing by considering the thermal response of the ES1A and the input response speed of the ES100X/P.

Analog Operation Assignment Table

Allocation	PV	AU1
Process 1	MOV	SW1
Argument 1	AU1	AI1
Argument 2	---	AU1
Process 2	END	END
Argument 1	---	---
Argument 2	---	---

Digital Operation Assignment Table

Allocation	DA1
Process 1	BUF
Argument 1	DI1
Argument 2	---
Process 2	END
Argument 1	---
Argument 2	---

**Note** The value in the analog user buffer AU1 will be refreshed only when the DI1 is ON. The PV always reflects the value in the analog user buffer. The PV will be kept on hold until the value in the analog user buffer is refreshed by temperature input that is turned ON by the next workpiece.

7-1-2 Example with K3NH

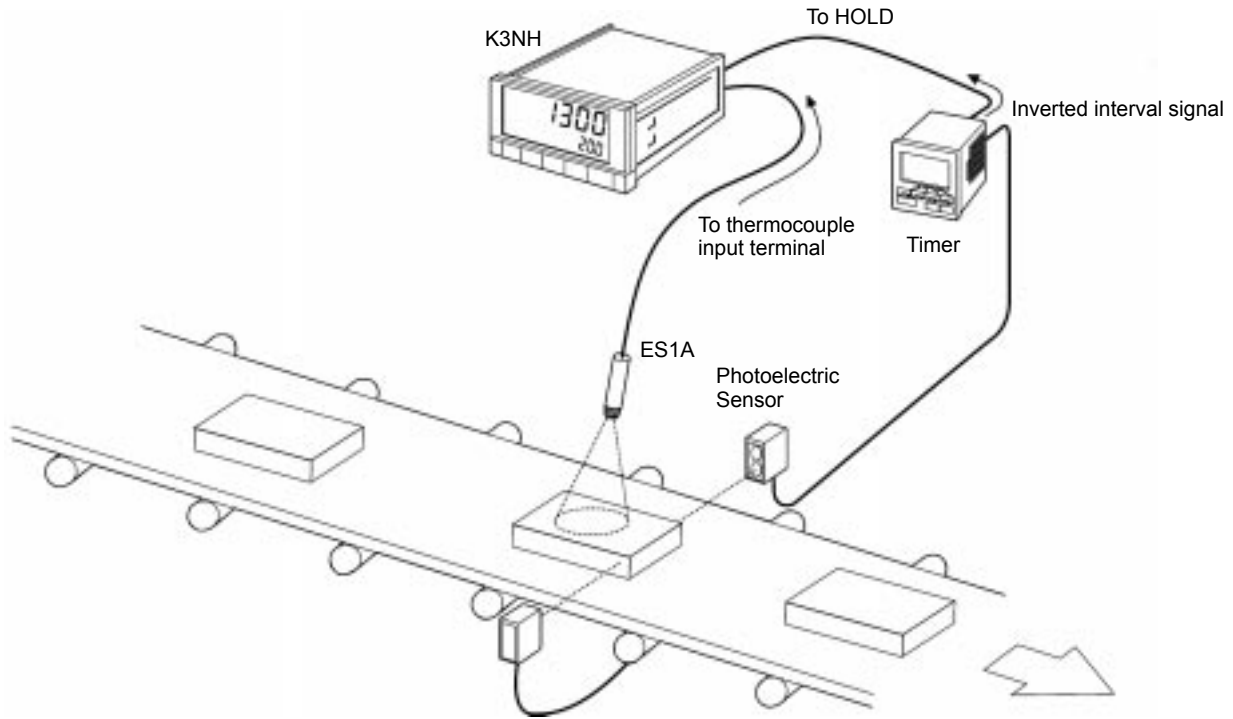

When the Photoelectric Sensor detects the workpiece, the Photoelectric Sensor will transmit a signal to the timer. The timer receives the signal and transmits an inverted interval signal to the HOLD terminal of the K3NH. Temperature input from the ES1A is enabled for a period set in the timer after the signal is turned ON due to the clearing of the on-HOLD status of the K3NH.

**Note** Set the temperature input timing by considering the thermal response of the ES1A and the input response speed of the K3NH.

## 7-2 Continuous Furnace (Thermal Treatment of Sheets)

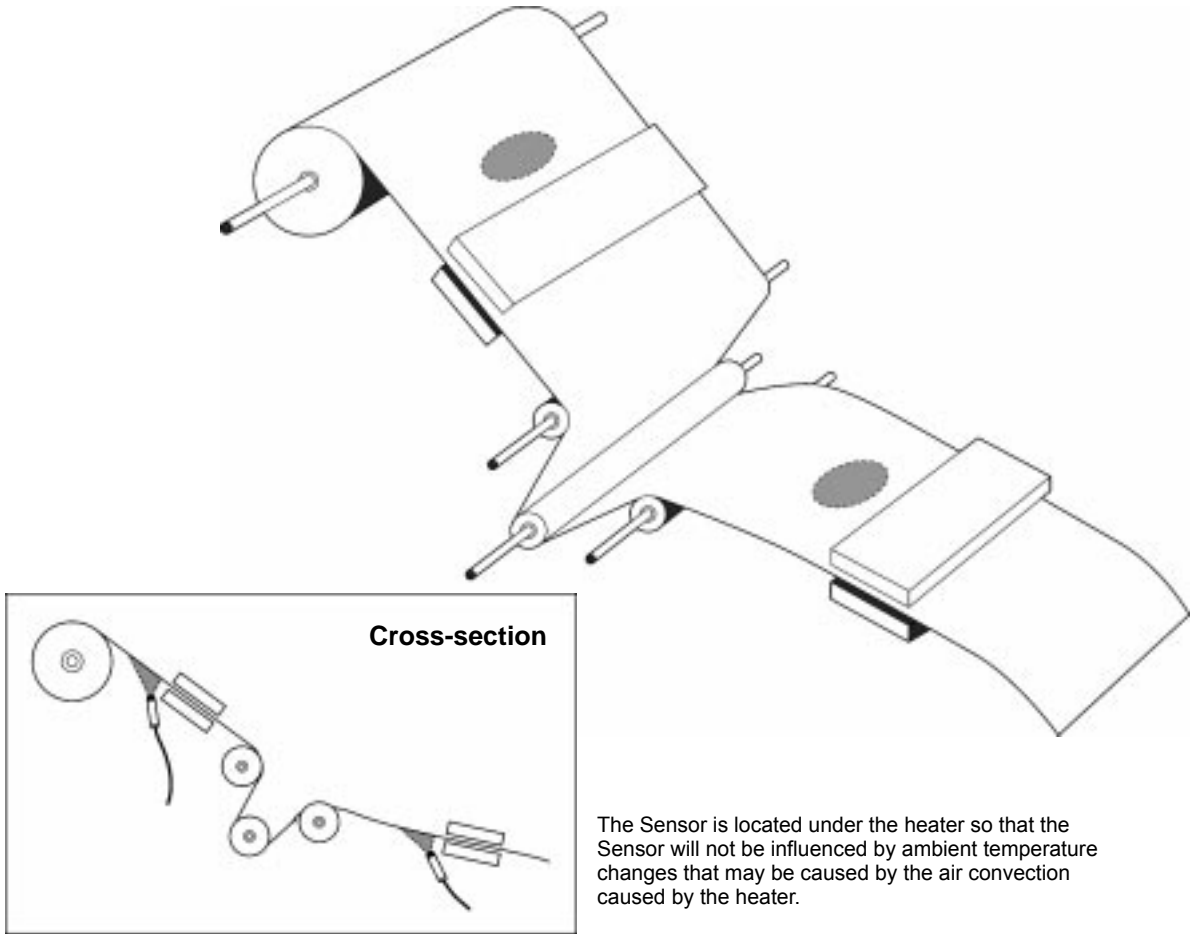

### Sheet Temperature Monitoring after Thermal Treatment with Heater

Mount the Sensor as shown below so that it will not be influenced by the heat radiated by the heater.

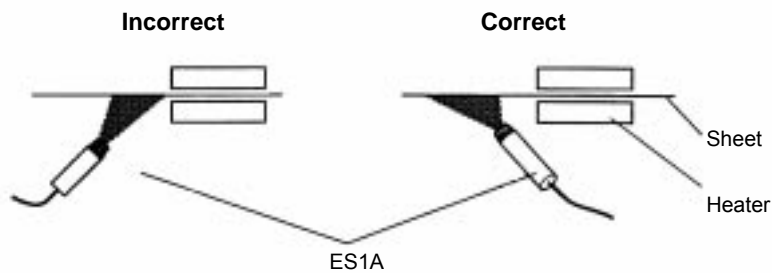

## 7-3 Air Purge

An air purge not only cools down the Sensor but also keeps the Sensor free of condensation and dust and eliminates all foreign matter that obstructs temperature measurement from the sensing range.

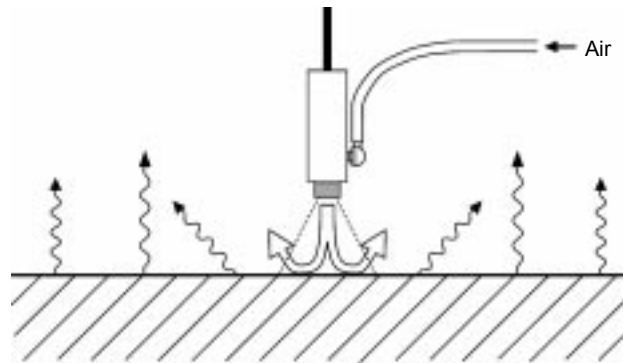

**Note** Carefully consider the location of the ES1A and the quantity of air provided so that the sensing object will not be cooled down by the air blowing from the Sensor.

## 7-4 Monitoring Hot-melt Adhesive Application

In the following system that uses two ES1A Units, the temperature difference of sensing spots is measured. This system makes it possible to monitor the application of hot-melt adhesive.

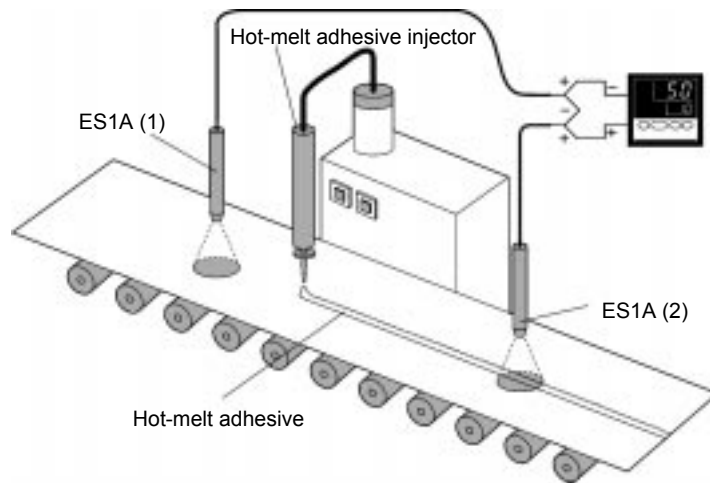

### 7-4-1 Example with E5□N

- 1, 2, 3... 1. When signals from the Sensor are input into the range of thermocouple input or non-contact temperature sensor input, the room temperature will be added to the detected difference in temperature by the built-in cold junction compensating circuit of the Temperature Controller. To prevent this, use the 0-to-50 mV input range of the E5□N.
2. A potential range between 0 and 50 mV generated by the K-type thermocouple is equivalent to a temperature range between 0°C and approximately 1,232°C. By converting the 0-to-50 mV range into this temperature range, the difference in temperature can be easily displayed. The potential range of the K-type thermocouple is, however, not converted linearly. The displayed difference in temperature, therefore, should be used for reference only.

3. Theoretically, the displayed difference in temperature will be 0 if there is no difference between the ES1As in monitored temperature (i.e., no hot-melt adhesive has been applied). There will be a difference in temperature when hot-melt adhesive is applied in normal operation. By setting the upper-limit alarm value to the mid-point between the two temperatures, an alarm will turn ON if the normal operation of hot-melt adhesive application fails.

- Note**
1. In the previous system, the temperature of the adhesive itself is not measured. The difference between the sensing spots of the ES1As in temperature will be detected instead. Therefore, the hot-melt adhesive need not be in the central part of each sensing spot.
  2. As shown in the previous illustration, be sure to connect the ES1A on the high-temperature side to the positive terminal of the Temperature Controller and the ES1A on the low-temperature side to the negative terminal, otherwise a sensor error may result.



## **SECTION 8**

# **Troubleshooting**

This section provides probable causes and remedies of ES1A errors.

<b>Error</b>	<b>Probable cause</b>	<b>Remedy</b>
Displayed PV is higher than actual temperature.	The input shift compensation of the Temperature Controller has not been performed yet.	Refer to <i>Section 5 Input Shift for Temperature Controller</i> and perform the input shift compensation of the Temperature Controller.
Displayed PV is lower than actual temperature.	There is dust on the filter.	Clean the filter with alcohol and a soft cloth. Be sure not to damage the filter surface.
	Xenon gas has leaked from the thermopile.	The Sensor is beyond repair and must be replaced.
Displayed PV does not change.	The wires are short-circuited or open.	Connect the wires correctly.
	The thermopile wires have burnt out.	The Sensor is beyond repair and must be replaced.

# Appendix

## Radiation Rates

	Material	Radiation rate	Material	Radiation rate
<b>Metal</b>	Aluminum		Iron oxide	0.78 to 0.82
	Pure aluminum and highly shiny aluminum	0.04 to 0.06	Red rusty iron	0.69
	Aluminum oxide (600°C)	0.76	Lead oxidized and turned gray	0.28
	Aluminum plate sold at stores	0.09	Mercury	0.09 to 0.12
	Brass		Molybdenum filament	0.10 to 0.20
	Pure brass and highly shiny brass plate	0.10	Nickel	
	Brass oxide (600°C)	0.56 to 0.64	Shiny nickel Nickel oxide plate (600°C)	0.07
	Shiny chrome	0.08 to 0.36	Nickel oxide	0.90
	Chrome oxide	0.81	Platinum	
	Copper		Shiny platinum plate	0.05 to 0.10
	Shiny copper	0.05	Platinum wire	0.07 to 0.18
	Heated at 600°C	0.78	Shiny silver	0.03 to 0.28
	Uneven bronze surface	0.55	Stainless steel	
	Shiny pure gold	0.02 to 0.03	Shiny stainless steel	0.07
	Iron and steel (except stainless steel)		SUS310 oxidized in oven	0.45
	Shiny iron	0.14 to 0.38	Shiny tin	0.06
	Shiny cast iron	0.21	Aged Tungsten filament	0.03 to 0.35
	Shiny cast iron Cast iron oxide (600°C)	0.28	Zinc	
	Shiny cast iron Cloudy cast iron oxide	0.94	Commercially available shiny pure zinc	0.05
	Rusty iron plate	0.69	Galvanized sheet	0.21
	Shiny steel Steel oxide (600°C)	0.07	Zinc oxide	0.11 to 0.28
	Thin steel plate and roll	0.06	Titanium oxide	0.40 to 0.60
	Unpolished steel plate	0.94 to 0.97		

	Material	Radiation rate	Material	Radiation rate
<b>Non-Metal</b>	Asbestos	0.93 to 0.94	Water	0.92 to 0.96
	Brick		Ice	0.96 to 0.98
	Red, unpolished	0.93	Snow	0.83
	Fire clay	0.75	Opaque quartz	0.85 to 0.95
	Carbon		Ceramics	0.90 to 0.94
	Filament	0.53	Marble	0.94
	Soot and carbon film	0.84 to 0.95	Phosphate	0.30 to 0.40
	Paint, lacquer, and varnish		Gypsum	0.80 to 0.90
	Lacquer	0.80 to 0.95	Mortar	0.89 to 0.91
	White enamel	0.91	Red brick	0.93 to 0.95
	Black lacquer	0.96 to 0.98	Fiber	0.90
	Aluminum paint	0.27 to 0.67	Black cloth	0.98
	Oil paint in 16 colors	0.92 to 0.96	Human skin	0.98
	Glass (Pyrex, lead, and sodium)	0.92	Lather	0.75 to 0.80
	Shiny yellowish white marble	0.68 to 0.92	Charcoal powder	0.96
	Asphalt	0.90 to 0.98	Black rubber	0.94
	Concrete	0.94	Plastic	0.85 to 0.95
	Cement	0.96	Lumber	0.90
	Sand	0.90	Paper	0.70 to 0.94
	Earth	0.92 to 0.96		

