

## Temperature Controllers

## E5□J

Advanced PID Controller with Fuzzy Logic-Based Adaptive Tuning Provides Optimum Performance

- Available in 3 standard DIN sizes:  
Choose 1/4, 1/8 and 1/16 DIN
- Fuzzy adaptive tuning continually optimizes PID control based on current process conditions
- Field selectable sensor inputs, alarm functions and °F/°C scaling
- Digital inputs allow Run/Stop operation and external selection of multiple set points on 1/4 and 1/8 DIN units
- Plug-in outputs on 1/4 and 1/8 DIN units provide field interchangeability and easy servicing
- 1/4 and 1/8 DIN units offer serial communication options for interfacing with PLCs and other host devices



## Ordering Information

### ■ 1/4 and 1/8 DIN CONTROLLERS

Order control outputs separately below; for example, E5AJ-A2HB-F with E53-R output unit. All temperature controllers with communications capability have the designated board installed, except E5□J-A2HM-F. The E5□J-A2HM-F offers interchangeable communications boards that must be ordered separately. To order controllers marked for Celsius, drop the final "F" from the part number.

Size	Standard	Part Number			
		Serial communications board installed			Communications ready
		RS-232C	RS-422	RS-485	(no board installed)
1/4 DIN	E5AJ-A2HB-F	E5AJ-A2H01-F	E5AJ-A2H02-F	E5AJ-A2H03-F	E5AJ-A2HM-F
1/8 DIN	E5EJ-A2HB-F	E5EJ-A2H01-F	E5EJ-A2H02-F	E5EJ-A2H03-F	E5EJ-A2HM-F

### ■ 1/16 DIN CONTROLLERS

Description	Part Number		
	Relay output	Voltage output	Current output
Two alarm points; one event input, heater burnout alarm (except current)	E5CJ-R2HB-F	E5CJ-Q2HB-F	E5CJ-C2B-F
Two alarm points; without event input	E5CJ-R2-F	E5CJ-Q2-F	E5CJ-C2-F
Without alarm and event input	E5CJ-R-F	E5CJ-Q-F	E5CJ-C-F

### ■ CONTROL OUTPUTS FOR 1/4 AND 1/8 DIN MODELS, CURRENT TRANSFORMERS

Description	Feature	Part number
Control outputs	SPDT relay, 5 A, 250 VAC*	E53-R
	SSR, 1 A, 75 to 250 VAC	E53-S
	Voltage, 12 VDC, NPN	E53-Q
	Voltage, 24 VDC, NPN	E53-Q3
	Voltage, 24 VDC, PNP	E53-Q4
	Linear current, 4 to 20 mA DC, 600 Ω	E53-C3
	Linear current, 0 to 20 mA, 600 Ω	E53-C3D
	Linear voltage, 0 to 10 VDC, 1 KΩ	E53-V34

## ■ CONTROL OUTPUTS FOR 1/4 AND 1/8 DIN MODELS, CURRENT TRANSFORMERS(continued)

	Linear voltage, 0 to 5 VDC, 1 K $\Omega$	E53-V35
Current transformers for heater burnout function	5.8 mm (0.23 in) dia. hole	E54-CT1
	12.0 mm (0.47 in) dia. hole	E54-CT3

\*Note: If control period is less than 5 seconds, use solid state relay or voltage relay.

## ■ COMMUNICATIONS BOARDS FOR E5AJ, E5EJ CONTROLLERS

Output	Write to temperature controller	Read from temperature controller	Part number
RS-232C	Set temperature, alarm value	Set temperature, alarm value, proportional	E53-J01
RS-422	proportional band, integral time,	band, reset time, rate time, output variable	E53-J02
RS-485	rate time, event input.	set limits, process value	E53-J03

## ■ ACCESSORIES

Description		Part number
NEMA 4 covers	For E5CJ, 1/16 DIN size	Y92A-48N
	For E5EJ, 1/8 DIN size	Y92A-49N
	For E5AJ, 1/4 DIN size	Y92A-96N

## ■ REPLACEMENT PARTS

Description	Part number
Panel mounting adapter for E5CJ, supplied with each unit	Y92F-30

## ■ TEMPERATURE RANGES

Input type (switch selectable)	Thermocouple				Platinum RTD	
	Type K	Type J and L	Type T and U	Type N	100 $\Omega$	
Temperature range	$^{\circ}\text{C}$	-200 to 1,300	-100 to 850	-199.9 to 400.0	-200 to 1,300	-199.9 to 650.0
	$^{\circ}\text{F}$	-300 to 2,300	-100 to 1,500	-199.9 to 700.0	-300 to 2,300	-199.9 to 999.9
Unit of measure (main setting and alarm)	1 $^{\circ}$ C/F	1 $^{\circ}$ C/F	0.1 $^{\circ}$ C/F	1 $^{\circ}$ C/F	0.1 $^{\circ}$ C/F	

## ■ GET THE ADVANTAGE OF ADAPTIVE TUNING USING THREE ALGORITHMS

Omron's "J" series controllers use fuzzy adaptive tuning to continuously monitor and optimize PID constants while the controller operates. Three tuning algorithms are used to recalculate the PID constants within 500 ms *after* the process value stabilizes at set point:

- Step-response method
- Disturbance tuning
- Hunting tuning.

### Step-Response Method

This tuning method takes place on start-up and after an upward set point change heating applications or a downward set point change in a cooling application. Step-response tuning changes mainly impact the proportional band.

### Disturbance Tuning

This tuning method takes place when the temperature exceeds the stable range between one and three times before settling back to set point. Changes in tuning are mainly made to the derivative (rate) time.

### Hunting Tuning

This tuning method takes place when the temperature exceeds the stable range four or more times before settling back to set point. Changes in tuning are mainly made to the integral (reset) time.

### Step-Response Tuning

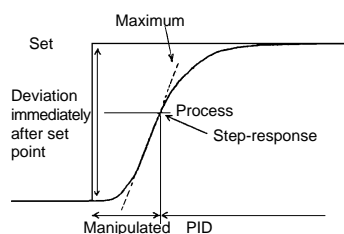

### Disturbance Tuning

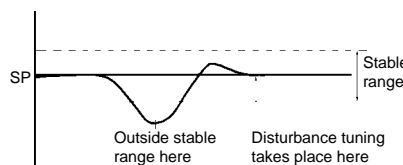

### Hunting Tuning

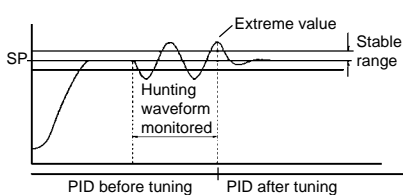

### Comparison of E5□J and E5□X Tuning Methods

Omron's "X" series controllers attempt to optimize the PID constants by using a limit cycle auto-tune. Although effective in most applications, this method has some drawbacks. For example, the auto-tuning must induce an upset into the process in order to make the process oscillate four times. In many processes these types of artificial upsets are not desirable. Adaptive tuning controllers do not induce an upset; instead, they use information from the actual process, eliminating unnecessary oscillations and enabling quicker start-up time.

Another drawback of the limit cycle auto-tune method is that PID constants will only be effective so long as the same basic conditions that were present when the auto-tune took place remain constant. Various factors such as a load change, heater performance degradation or set point changes can cause the auto-tuned values to be less than optimum. The new adaptive tuning method, however, is continually monitoring the process and will automatically adjust the PID constants when process parameters (i.e., heater degradation, load change, etc.) vary.

# Specifications

Part number		E5AJ	E5EJ	E5CJ
Supply voltage		100 to 240 VAC, 50/60 Hz		
Operating voltage		85% to 110% of supply voltage range		
Power consumption		Approx. 10 VA at 100 VAC to 14 VA at 240 VAC		Approx 10 VA at 100 VAC to 12 VA at 240 VAC
Temperature input type		Thermocouple types J, K, T, L, U, and N or platinum RTD (JPt 100/Pt100), selectable		
Event input	Contact input	ON: 1 k $\Omega$ max., OFF: 100 k $\Omega$ min.		
	No-contact input	ON: residual voltage: 3 V max., OFF: Leakage current 1 mA max.		
Control output	Type	Relay (see note 1)	SPST-NO, 5 A, 250 VAC using E53-R output unit	
		Voltage	NPN, 40 mA at 12 VDC using E53-Q output unit NPN, 20 mA at 24 VDC using E53-Q3 output unit PNP, 20 mA at 24 VDC using E53-Q4 output unit All offer short-circuit protection	
	Current	4-20 mA, DC, 600 $\Omega$ max., resolution of 2,600 using E53-C output unit (see note 1)		4-20 mA, 600 $\Omega$ max., resolution of 2,600
	Hysteresis		0.1° to 999.9° C/F in units of 0.1°C/°F during ON/OFF control action	
	Update time	Output	500 ms for pulse output	
		Display	500 ms	
	Service life	Electrical	100,000 operations minimum for E53-R and alarm	
	Mechanical	10 million moperations minimum for E53-R and alarm		
Alarm output	Number	Two SPST-NO relay,s 3 A, 250 VAC		Two, SPST-NO relays, 1 A, 250 VAC
	Setting range	Thermocouple types J, K, L, N: -1999 to 9,999 °C/°F in units of 1 °C/°F Platinum RTD and thermocouple types T and U: -199.9 to 999.9 °C/°F in units of 0.1 °C/°F		
Heater burnout output	Type	SPST-NO relay, 1 A, 250 VAC		
	Setting range	0.1 to 49.9 A in units of 0.1 A 0.0 setting disables the output 50.0 setting turns output ON continuously		
	Minimum detectable ON time	200 ms; heater current is not measured when the control output is ON less than 200 ms		
Indication accuracy	General	$\pm 0.5\%$ of set point or $\pm 1^\circ$ , whichever is greater, $\pm 1$ digit max.		
	Exceptions	Accuracy of types K, N and T thermocouples is $\pm 2^\circ\text{C}$ (3.6°F) from -100°C or below (-240°F or below), $\pm 1$ digit. Accuracy of type U thermocouple at any temperature is $\pm 2^\circ\text{C}$ (3.6°F), $\pm 1$ digit.		
Setting accuracy		Set value coincides with the indicated value, since no relative error exists between both values		
Display Range		-9999 to 9999 (limited by output type)		
Control mode	Type	PID with automatic fuzzy self-tuning, PID, or ON/OFF		
	Proportional band (P)	0.1 to 999.9 °C/°F in units of 0.1 °C/°F		
	Reset time (I)	0 to 3,999 seconds in 1-second units		
	Rate time (D)	0 to 3,999 seconds in 1-second units		
	Control period	Pulse output: 1 to 99 seconds in 1-second units		
	Sampling period	500 ms		
Memory protection		Non-volatile memory		
Other functions	Input shift	Offsets input value and display to accommodate a sensor input that deviates by a known value.		
Indicators	Miscellaneous	Thermocouple range: -999 to 9999 °C/°F Platinum RTD range: -99.9 to 999.9 °C/°F Upper and lower set value limits, setting protection, Normal and Reverse output		
	Present value	15 mm (0.59 in) red LED digits	14 mm (0.55 in) red LED digits	12 mm (0.47 in) red LED digits
	Set value	10.5 mm (0.41 in) green LED digits	9.5 mm 0.37 in) green LED digits	8 mm (0.32 in) green LED digits
	Other functions	LED indicators		

Note: 1. If control period is less than 5 seconds, use solid state relay or voltage relay.

Note: 2. The E53-C3 Current Output Unit cannot be used if heater burnout alarm is used.

# Specifications, continued

Materials		Plastic case		
Mounting		Fits 1/4 DIN panel cutouts, includes two panel mounting brackets	Fits 1/8 DIN panel cutouts, includes two panel mounting brackets	Fits 1/16 DIN panel cutouts, includes Y92F-30 panel mounting adapter
Weight	Controller	Approx. 360 g (12.7 oz.)	Approx. 280 g (9.9 oz.)	Approx. 170 g (6.0 oz.)
	Mounting hardware	Brackets 65 g (2.3 oz.)	Brackets 65 g (2.3 oz.)	Adapter 10 g (0.35 oz.)
Connections		Plated steel screw terminals mounted on rear of unit		
Enclosure ratings	Front panel	IEC IP54, NEMA 4 with optional Y92A covers (see note)		
	Rear case Terminals	IEC IP20 IEC IP00		
Approvals	UL	Recognized, File number E68481		
	CSA	Certified, File number LR59623		
Ambient temperature	Operating	-10° to 55° C (14° to 131°F)		
	Storage	-25° to 65°C (-13° to 149°F)		
Humidity		35 to 85% RH		
Insulation resistance		20 MΩ minimum at 500 VDC, measured with an output unit installed		
Dielectric strength		2,000 VAC, 50/60 Hz for 1 minutes between terminals of different polarities		
Vibration	Mechanical durability	10 to 55 Hz, 19.6 m/s <sup>2</sup> (2 G) in X, Y, and Z directions for 2 hours each		
	Malfunction durability	10 to 55 Hz, 9.8 m/s <sup>2</sup> (1 G) in X, Y, and Z directions for 10 minutes		
Shock	Mechanical durability	294 m/s <sup>2</sup> (30 G) in 6 directions, 3 times each		
	Malfunction durability	196 m/s <sup>2</sup> (20 G) in 6 directions, 3 times each		

Note: Optional NEMA 4 panel covers are available for E5-J controllers:  
Y92A-96N for E5AJ, Y92A-49N for E5EJ, and Y92A-48N for E5CJ

## ■ CURRENT TRANSFORMERS FOR E5AJ, E5EJ, E5CJ□2HB-F

Part number	E54-CT1	E54-CT3
Heater current	Maximum 50 A continuous service, single-phase	
Dielectric strength	1,000 VAC	
Vibration resistance	50 Hz (approx. 10 G)	
Weight	11.5 g (0.41 oz.)	50 g (1.8 oz.)
Accessories included	—	2 contacts, 2 plugs

## ■ COMMUNICATIONS FOR E5AJ, E5EJ

Protocol	RS-232C	RS-422	RS-485
Transmission method	4-wire half duplex	4-wire half duplex	2-wire half-duplex
Maximum cable length	15 m (49.2 ft)	500 m (1,640 ft)	500 m (1,640 ft)
Synchronization method	Start-stop synchronization (asynchronous method)		
Baud rate	1,200/2,400/4,800/9,600/19,200 bps		
Transmission code	ASCII (7 bits)		
Write to temperature controller	Set point, alarm value, remote/local selection, proportional band, integral time, rate time (see note)		
Read from temperature controller	Process value, output value, set point, alarm value, heater current value, initial status, proportional band, reset time, rate time, error codes, etc. (see note)		
System limits	Peer to peer only	A maximum of 32 controllers can be connected to one host computer in serial communication	

Note: If E5AJ is in ON/OFF control mode or PID control mode with fuzzy self-tuning, an undefined error will result if the proportional band, integral time, or derivative time command is transmitted.

# Dimensions

Unit: mm (inch)

## ■ E5AJ

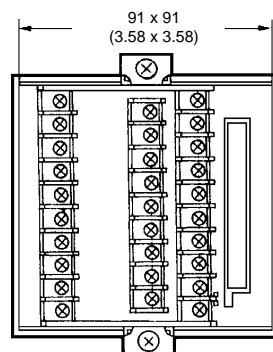
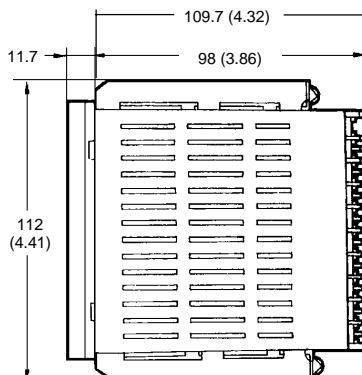
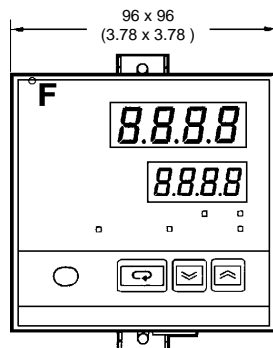
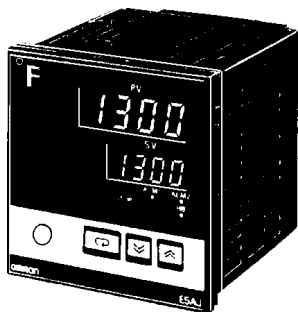

### Panel cutout

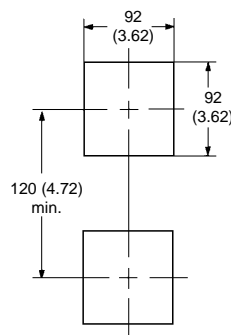

### Side-by-side mounting of several controllers

Recommended panel thickness is 1 to 8 mm (0.04 to 0.32 in).

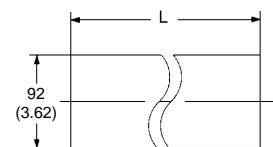

#### For side-by-side mounting:

$L = 96 \text{ mm} \times \text{number of units} - 3.5 \text{ mm}$   
( $3.78 \text{ in} \times \text{number of units} - 0.14 \text{ in}$ )

## ■ E5EJ

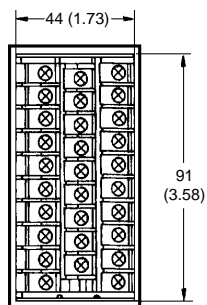
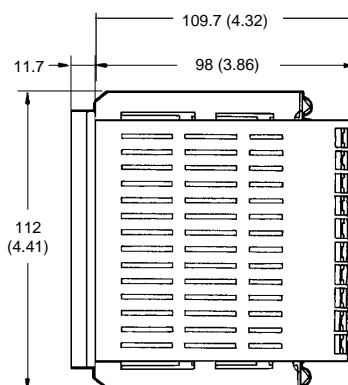
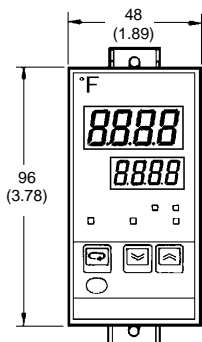
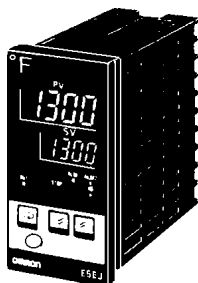

### Panel cutout

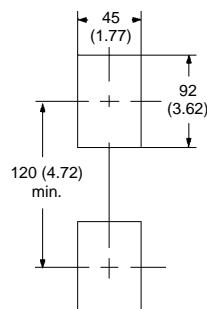

### Side-by-side mounting of several controllers

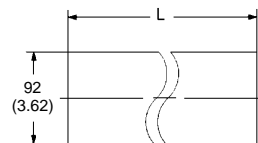

#### For side-by-side mounting:

$L = 48 \text{ mm} \times \text{number of units} - 2.5 \text{ mm}$   
( $1.89 \text{ in} \times \text{number of units} - 0.10 \text{ in}$ )

Recommended panel thickness is 1 to 8 mm (0.04 to 0.32 in).

■ E5CJ

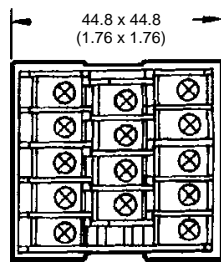
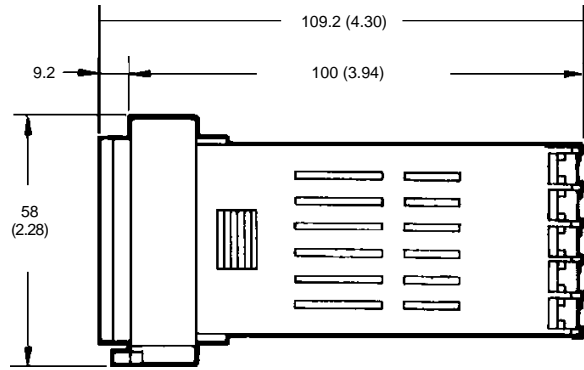
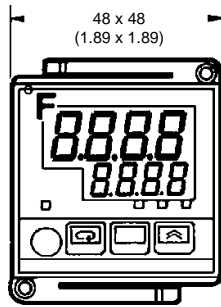

Panel cutout

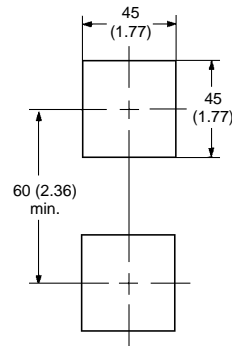

Side-by-side mounting of several controllers

Recommended panel thickness is 1 to 4 mm (0.04 to 0.16 in).  
Mounting bracket Y92F-30 allows close side-by-side mounting.

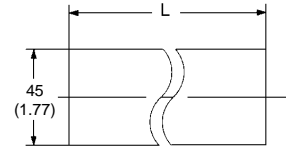

**For side-by-side mounting:**  
L = 48 mm x number of units - 2.5 mm  
= (1.89 in x number of units - 0.10 in)

# Nomenclature

## ■ E5AJ without communications

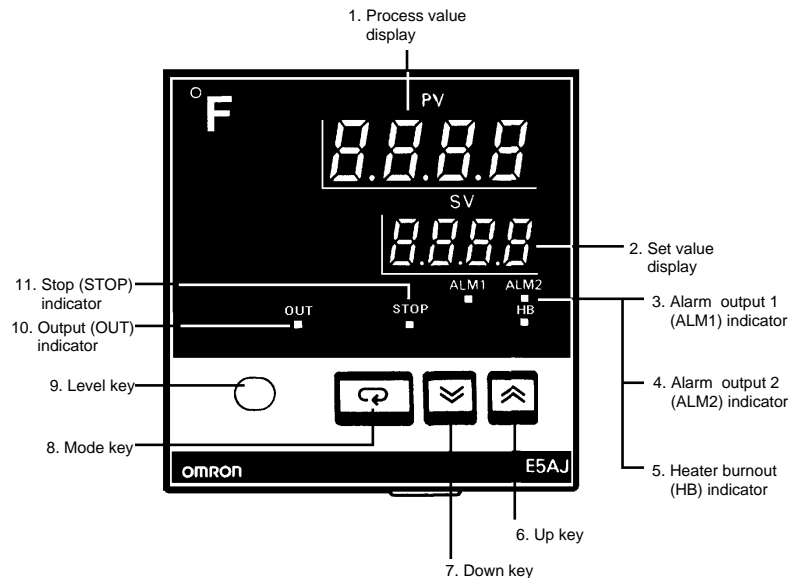

## ■ E5EJ with communications

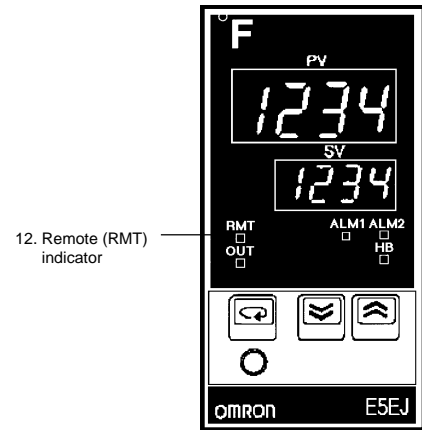

## ■ E5CJ without communications

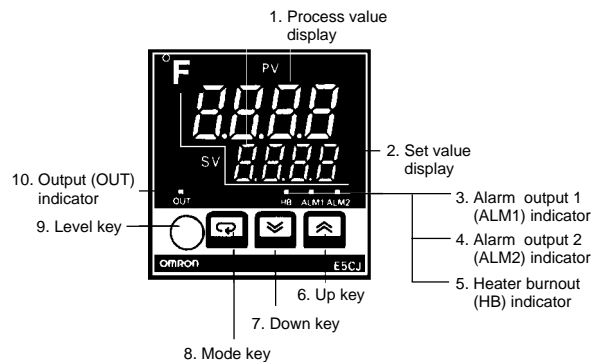

Key	Description	Key	Description
1	Process value indicator displays the present temperature, parameter being set and error messages.	7	Down key decrements the numeric value in the display. Pressed for 1 second or more, the display value decreases by 50 units in a second until the lower-limit value has been reached.
2	Set value indicator displays the set values, messages and output value.	8	Mode key changes the display mode within display levels.
3	Indicator lights when alarm output 1 is turned ON.	9	Level key changes the display level when depressed for at least 2 seconds.
4	Indicator lights when alarm output 2 is turned ON.	10	Output indicator lights when the control output is ON. It does not light when the output selector switch is set for a current output.
5	Heater burnout indicator lights when a heater burnout is detected and stays lit until reset.	11	Stop indicator lights when the temperature controller is not in operation.
6	Up key increments the numeric value in the display. Pressed for 1 second or more, the set value increases by 50 units in 1 second until the upper-limit value has been reached.	12.	Indicator lights when the controller is in remote (on-line) communication mode.

### Note:

- E5AJ and E5EJ models without communications have a Stop indicator.
- E5CJ-□2HB models have all indicators shown. E5CJ-□2 models have OUT, ALM1 and ALM2 indicators. E5CJ-□ models have OUT indicator only.

# Connections

## ■ E5AJ, E5EJ CONTROLLERS

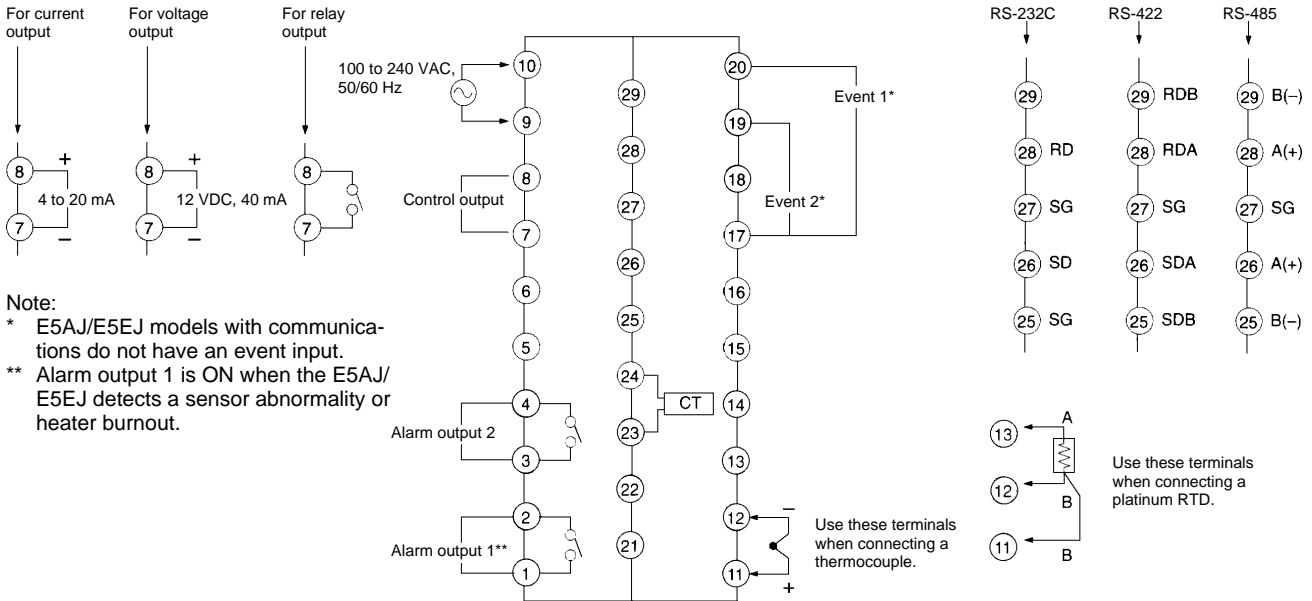

Note:

\* E5AJ/E5EJ models with communications do not have an event input.

\*\* Alarm output 1 is ON when the E5AJ/E5EJ detects a sensor abnormality or heater burnout.

## ■ E5CJ-□2□B CONTROLLERS

Two Alarm Outputs, One Event Input, Heater Burnout Alarm

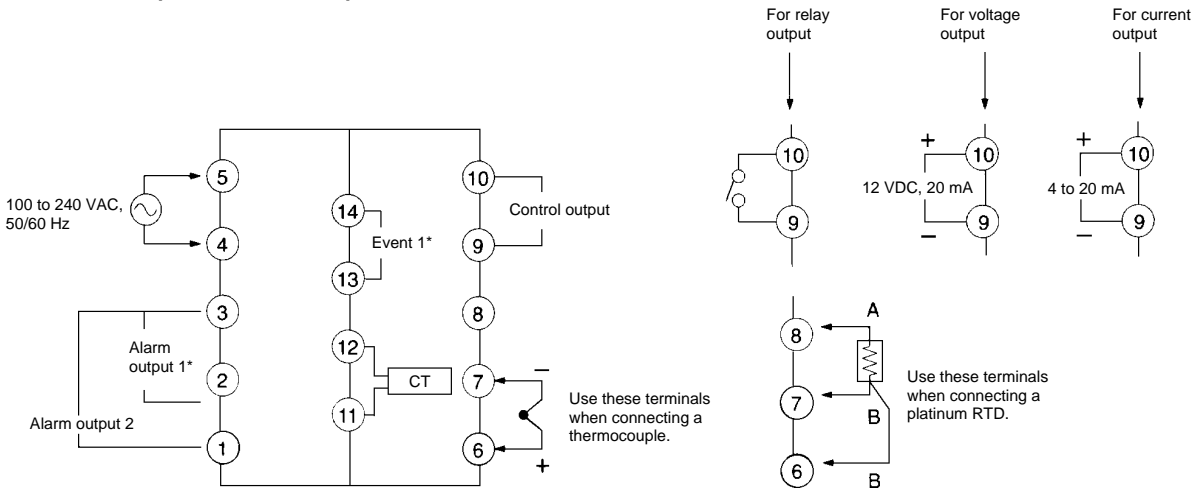

Note:

\* Alarm output 1 is ON when the E5AJ/E5EJ detects a sensor abnormality or heater burnout.



## ■ E5CJ-□2 CONTROLLERS

Two Alarm Outputs, No Event Input

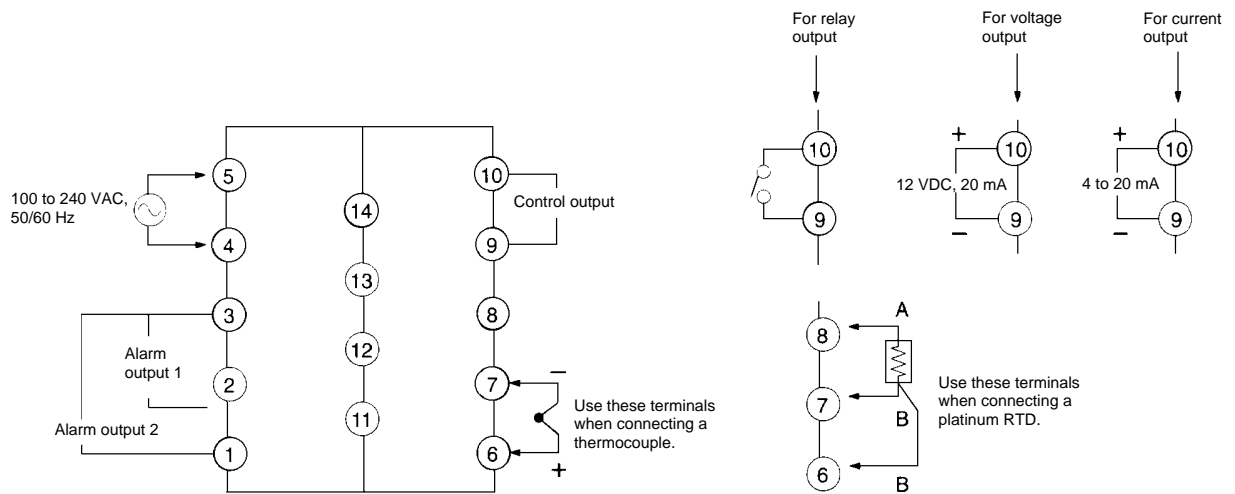

## ■ E5CJ-□ CONTROLLERS

No Alarm Outputs, No Event Input

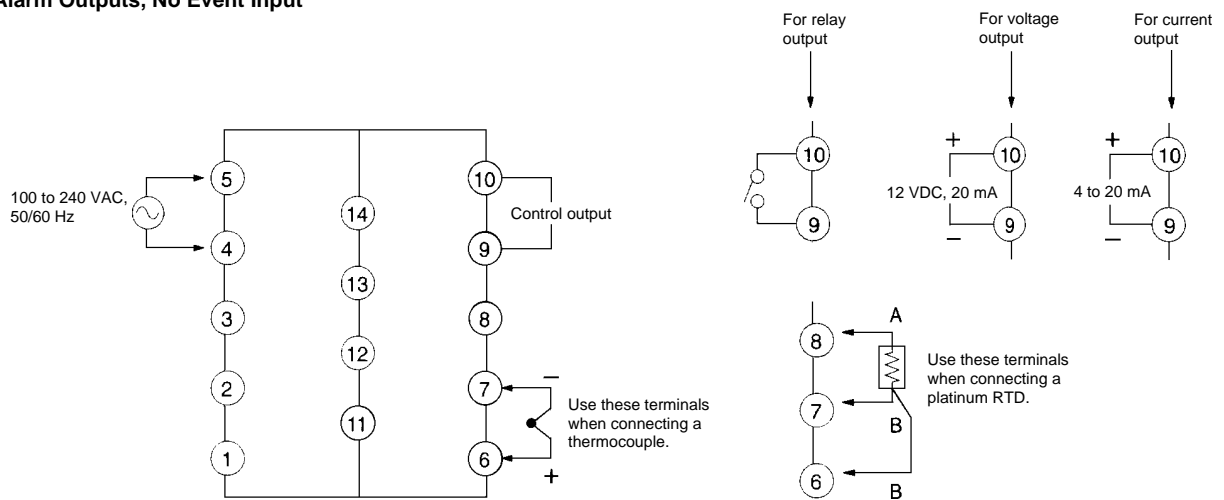

# OMRON

OMRON ELECTRONICS, INC.

One East Commerce Drive

Schaumburg, IL 60173

1-800-55-OMRON

OMRON CANADA, INC.

885 Milner Avenue

Scarborough, Ontario M1B 5V8

416-286-6465