

E32-V

Vacuum Sensor

The Ideal Vacuum Sensor with an Easy-to-use Multi-channel Flange for High-vacuum Applications.

Achieves the Industry's First Snap-on Fiber Mounting.

Vacuum Sensor

E32-V

Suitable for Object Detection under Vacuum with an Easy-to-use One- or Multi-channel Flange and Snap-on Fiber Mounting

- Saves vacuum chamber space with a four-channel flange.
- Greatly reduces work steps with the four-channel flange and snap-on fiber mounting.
- The fiber unit for outside can be freely cut on both ends, thus avoiding messy routing.
- A one-channel, screw-mounting flange is also available.



Ordering Information

■ **Configuration Example (Typical)**

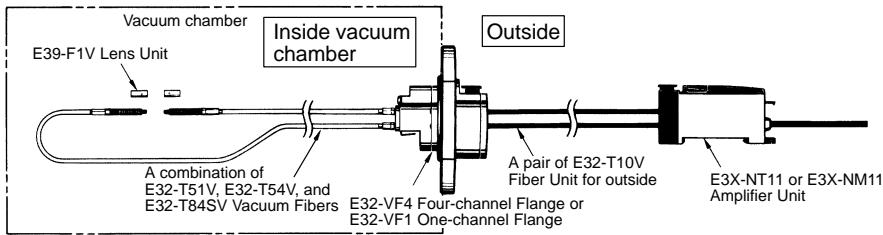

■ **Flanges**

Item	Four-channel	One-channel
Model	E32-VF4	E32-VF1

■ **Vacuum Fibers**

Item	Through-beam, straight model	Through-beam, L-shaped model	Through-beam, Heat-resistant model
Model	E32-T51V 1M E32-T51V 0.5M	E32-T54V 1M E32-T54V 0.5M	E32-T84SV 1M E32-T84SV 0.5M

■ **Fiber Unit for Outside**

Model	E32-T10V 2M
--------------	-------------

■ **Lens Unit (Sold Separately)**

Item	Long-distance
Model	E39-F1V

■ Amplifier Units

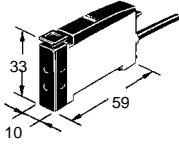
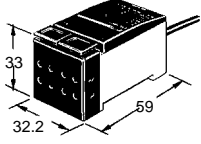
Item	General-purpose	Multi-function	Four-channel
Model	E3X-NT11 (NPN output) E3X-NT41 (PNP output)	E3X-NT21 (NPN output) E3X-NT51 (PNP output)	E3X-NM11 (NPN output) E3X-NM41 (PNP output)
Appearance			
Light source	Red LED ($\lambda = 680 \text{ nm}$)		
Power supply voltage	12 to 24 VDC $\pm 10\%$, ripple (p-p) 10% max.		
Current consumption	50 mA max.		150 mA max.
Response time	500 μs max. at rated sensing distance		
Control output	PNP or NPN open collector, load current: 100 mA, residual voltage: 1 V max.		
Timer function (see note)	---	OFF-delay timer (fixed to 40 ms)	OFF-delay timer (fixed to 40 ms) (independent channel)
Teaching confirmation function	Indicator (red/green LEDs) and buzzer		
Remote teaching input	---	Pink and blue (0 V) wires are short-circuited when remote input is ON. (0 V short-circuit current: 1 mA max.) Pink and blue (0 V) wires are not short-circuited when remote input is OFF. (Open or 9 V min.; max. input voltage: 24 V) Response time is 0.5 ms max. when remote input is OFF.	
Output	Light ON and Dark ON switch selectable		

Note: It is possible to disable the OFF-delay timer function by using the switch setting.

Specifications

■ Ratings/Characteristics

Flanges

Item	E32-VF4	E32-VF1
Number of channels	Four-channel	One-channel
Optical leakage	$1 \times 10^{-10} \text{ Pa} \cdot \text{m}^3/\text{s}$ max.	
Ambient operating temperature	-25°C to 55°C (with no icing)	
Material	Aluminum (A5056)	Stainless steel (SUS304)
Flange seal material	Fluoro rubber	
Weight	Approx. 250 g	Approx. 220 g

Fiber Unit for Outside

Item	E32-T10V	
Standard length	2 m (cut freely)	
Ambient operating temperature	-25°C to 70°C (with no icing)	
Permissible bending radius	25 mm max.	
Material	Core	Acrylic resin
	Sheath	Fluoride resin
	Protection tube	Black polyethylene

Vacuum Fibers

Item	E32-T51V	E32-T54V	E32-T84SV	
Sensing method	Through-beam			
Standard length	1 m (not cut freely)			
Sensing distance	E3X-NT11 or E3X-NM11	60 mm	40 mm	150 mm
	E3X-H11	100 mm	65 mm	250 mm
Ambient operating temperature	-25°C to 120°C (with no icing)		-25°C to 200°C	
Permissible bending radius	30 mm max.		25 mm max.	
Material	Core	Quartz		Optical glass
	Sheath	Fluoride resin		Optical glass
	Protection tube	Fluoride resin		Stainless steel (SUS304)
	Fiber head/Connection tube	Aluminum (A5056), Stainless steel (SUS304)		

Lens Unit

Item	E39-F1V		
Applicable fiber	E32-T51V	E32-T54V	
Sensing distance	E3X-NT11 or E3X-NM11	360 mm	240 mm
	E3X-H11	600 mm	390 mm
Ambient operating temperature	-25°C to 120°C (with no icing)		
Material	Housing	Aluminum (A5056)	
	Lens	Optical glass	

Amplifier Unit

Item	E3X-NT11	E3X-NT41	E3X-NT21	E3X-NT51	E3X-NM11	E3X-NM41
NPN/PNP output	NPN	PNP	NPN	PNP	NPN	PNP
Indicator	Orange LED: Lit during output operation Green LED: Lit with stable light reception or no light					
Circuit protection	Reverse polarity, Output short-circuit					
Ambient temperature	Operating: -25°C to 55°C (with no icing) Storage: -40°C to 70°C (with no icing)					
Ambient humidity	Operating: 35% to 85% (with no condensation)					
Ambient illumination	Sunlight: 10,000 lx max.; Incandescent lamp: 3,000 lx max.					
Insulation resistance	20 MΩ min. (at 500 VDC)					
Dielectric strength	1,000 VAC, 50/60 Hz for 1 min					
Vibration resistance	10 to 55 Hz, 1.5-mm double amplitude or 300 m/s ² (approx. 30G) for 2 hrs each in X, Y, and Z directions					
Shock resistance	500 m/s ² (approx. 50G) for 3 times each in X, Y, and Z directions					
Enclosure rating	IEC IP50 (with protective cover in place)					
Material	Case: PBT; Cover: Polycarbonate					
Connection method	2-m cord-drawing method V _{CC} : Brown 0 V: Blue Control output: Black Remote teaching input: Pink (E3X-NT21/-NT51 only)			2-m cord-drawing method V _{CC} : Brown 0 V: Blue Control output 1: Black Control output 2: White Control output 3: Grey Control output 4: Orange Remote teaching input: Pink		
Weight (with 2-m cord)	Approx. 100 g			Approx. 200 g		

Engineering Data (with E3X-NM11 Amplifier Unit)

■ Excess Gain Ratio vs. Distance Characteristics (Typical)

E32-T51V

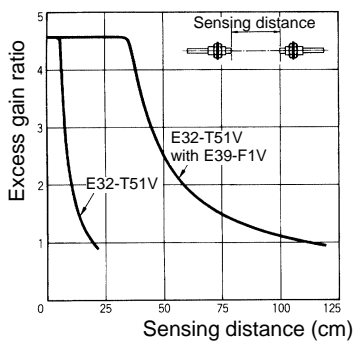

E32-T54V

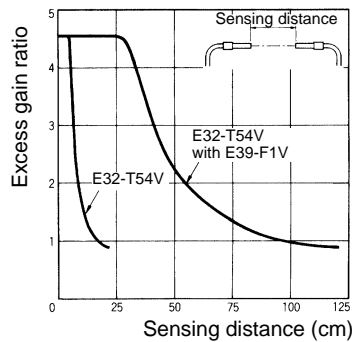

E32-T84SV

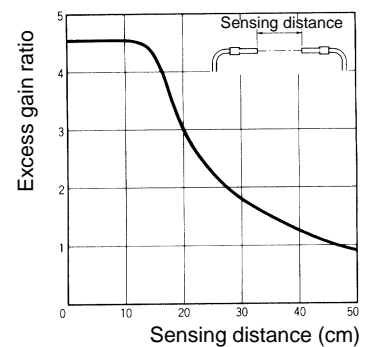

■ Parallel Operating Range (Typical)

E32-T51V

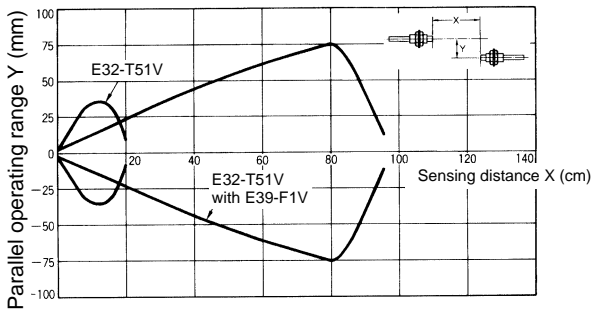

E32-T54V

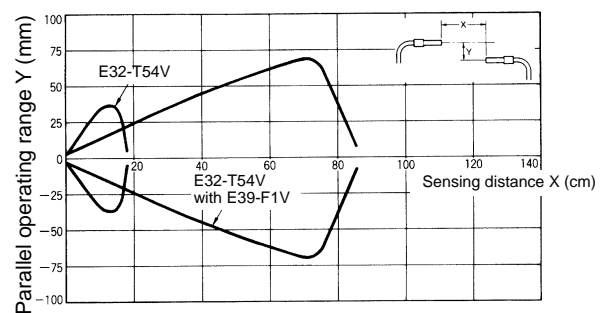

E32-T84SV

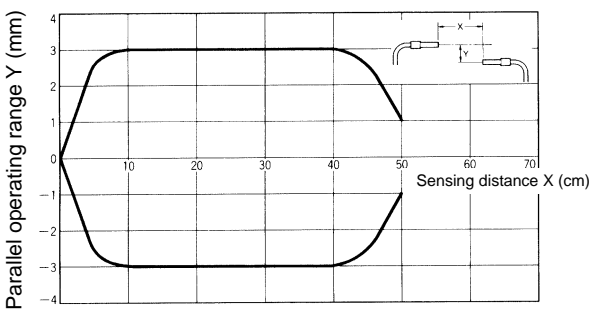

Nomenclature

E3X-NT11
E3X-NT21
E3X-NT41
E3X-NT51

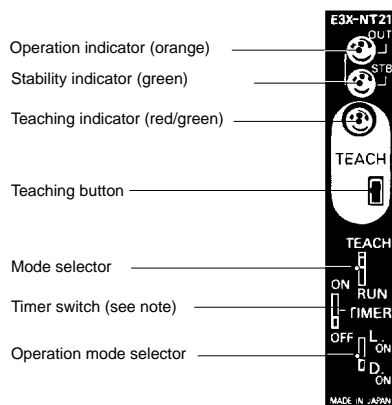

- Operation indicator (orange)
- Stability indicator (green)
- Teaching indicator (red/green)
- Teaching button
- Mode selector
- Timer switch (see note)
- Operation mode selector

E3X-NM11
E3X-NM41

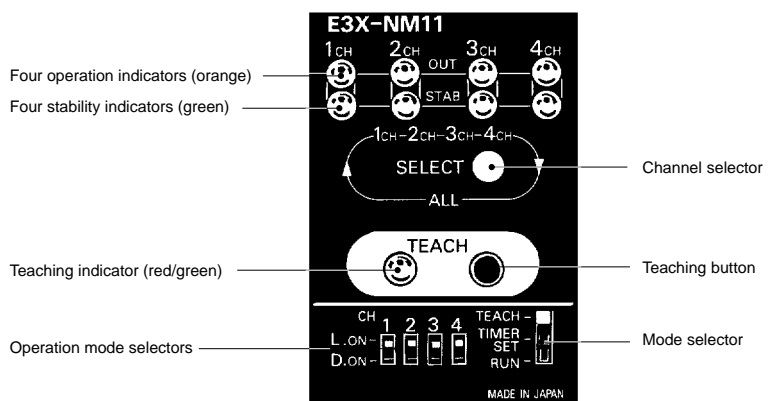

- Four operation indicators (orange)
- Four stability indicators (green)
- Channel selector
- Teaching indicator (red/green)
- Teaching button
- Mode selector

Note: The E3X-NT11 or E3X-NT41 do not have a timer function.

Operation

■ Output Circuits

E3X-NT11

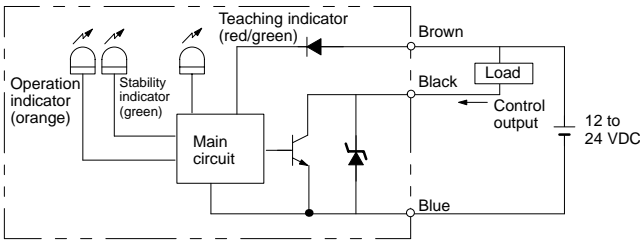

E3X-NT21

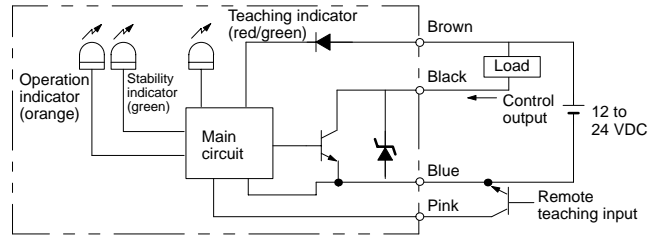

E3X-NM11

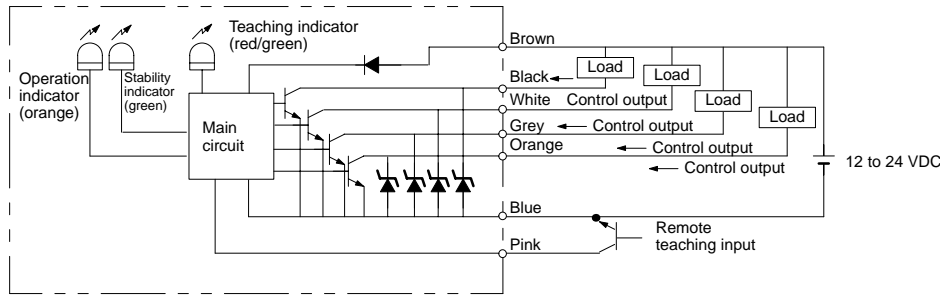

E3X-NT41

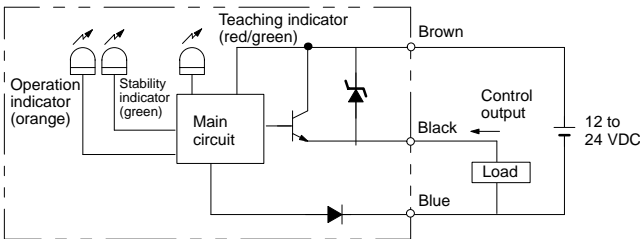

E3X-NT51

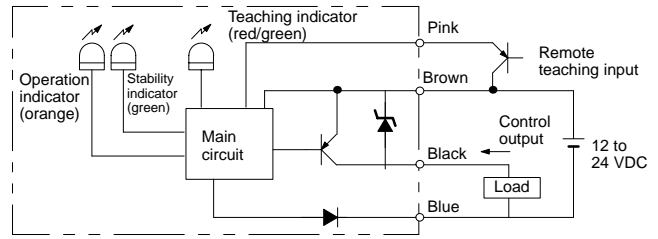

E3X-NM41

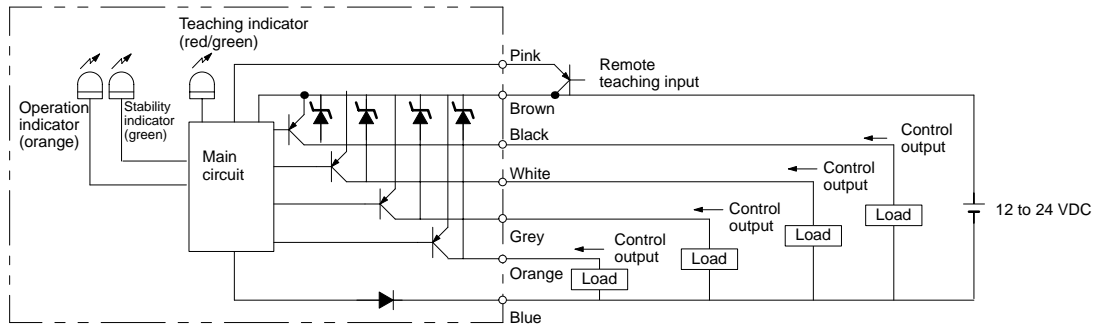

Channel no.	Control output wire color
1	Black
2	White
3	Grey
4	Orange

■ With/Without-object Teaching, No-object Teaching, Maximum Sensitivity Setting

Refer to the following table to select the most suitable sensitivity setting method.

Sensitivity setting method	Maximum sensitivity setting	No-object teaching	With/Without-object teaching
Typical application	Detection of the existence of objects that interrupt light perfectly Detection of objects with no background objects	If teaching is impossible by stopping the movement of sensing objects To detect bright or dark objects by teaching only with background objects	Detection of a slight difference in reflection Color discrimination Background objects with unstable reflection Detection of object surface irregularities
		Elimination of background object influence	

- Note:**
1. None of the four channels has any output when the E3X-NM (four channels) is in teaching mode (i.e., all the four channels will be in teaching mode).
 2. If the set distance is very short (i.e., 0 to 12 mm for the E32-TC200 and 0 to 4 mm for the E32-DC200), no-object teaching is not possible due to excessive light, in which case, perform with/without-object teaching.
 3. In principle, use the E3X-NM (four channels) for the close connection of a maximum of four Fiber Units. When closely connecting two to three Fiber Units to more than one E3X-NT (one channel), perform with/without-object teaching, in which case teaching must be performed on a single E3X-NT at a time. Therefore, turn on only the E3X-NT on which teaching is performed. If all the E3X-NTs are turned on, interrupt the emitters of the Fiber Units on which teaching is not performed.

■ No-object Teaching with an Initial Operating Level Compensation Function With Through-beam (Dark-ON) Fiber Unit

1. Teaching button is pressed once.
2. The first sensing object is in the sensing area.

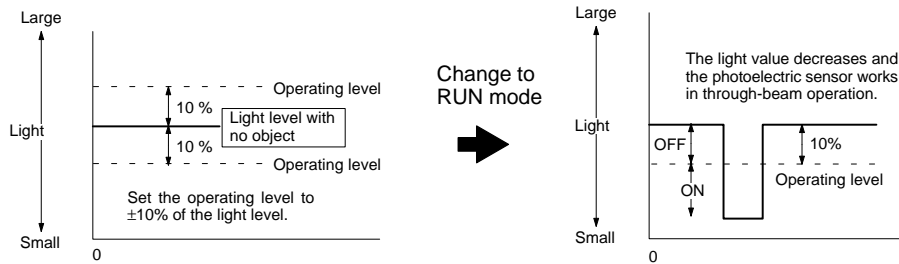

3. Sensing objects continue to pass through the sensing area.

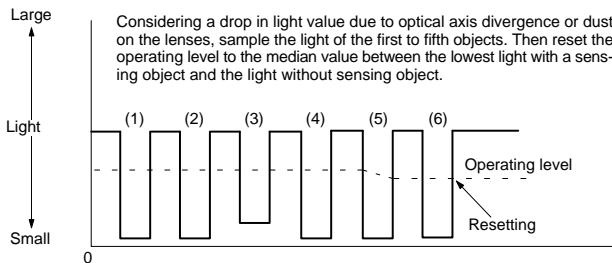

With Reflective (Light-ON) Fiber Unit

1. Teaching button is pressed once.

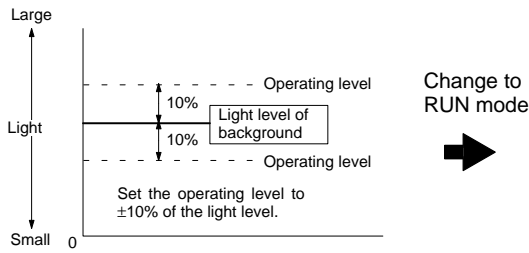

2. The first sensing object is in the sensing area.

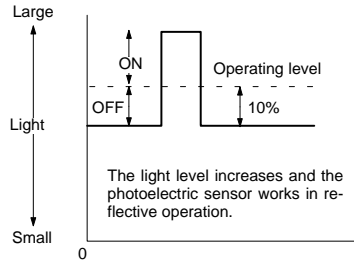

3. Sensing objects continue to pass through the sensing area.

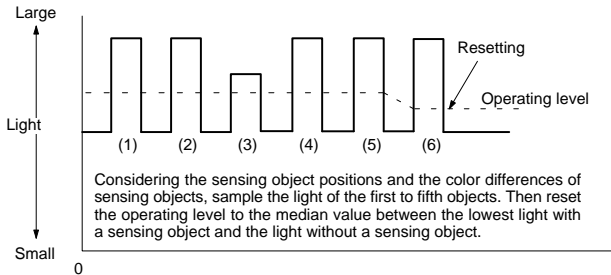

Note: If the light value up to the fifth object is at least twice as large as the operating level, the initial set operating level (10%) will be maintained.

- Note:**
- After no-object teaching, when the E3X-N□ is turned off and on, the operation level will be set to the +10% of the initial light level (refer to the above (1)) in reflective operation and -10% of the initial light level in through-beam operation and stand by.
 - After performing no-object teaching and changing to RUN mode, until the first sensing object is in the sensing area, the control output will be prohibited (OFF). The control output will be determined when the first sensing object is detected.
 - The initial operating level compensation function will operate after teaching and/or after the E3X-N□ is turned on.
 - During no-object teaching, after the E3X-N□ is in RUN mode, each channel requires approximately 60 ms to determine the operating level from the time the first sensing object is in the sensing area. Therefore, when using the E3X-NM (four channels), set an interval of 60 ms minimum for each channel if sensing objects are forwarded in sequence to the sensing area of each channel. After the operating level is determined, the E3X-NM will operate with a normal response speed of 500 μs.

■ Sensitivity Adjustment

Combination of the E3X-NT/E3X-NM and Fine Through-beam Fiber Units (E32-T22S/T24S)

No-object Teaching

Press the teaching button once with no wafer in the sensing area.

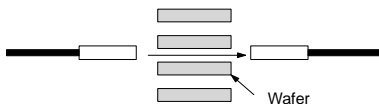

With/Without-object Teaching

Press the teaching button once with no wafer in the sensing area.

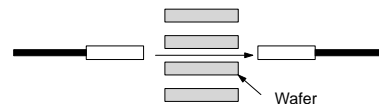

Note: If detection is not stable after no-object teaching, perform with/without-object teaching.



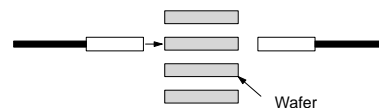

Press the teaching button once again with a wafer in the sensing area.





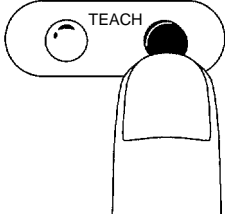

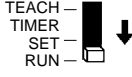

Maximum Sensitivity Setting

Note: The sensitivity of the E3X-NT and E3X-NM are set to maximum before shipping. When resetting the sensitivity of the E3X-NT or E3X-NM to maximum after no-object teaching or with/without-object teaching, follow the steps described below.

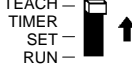
Procedure	Operation	E3X-NT	E3X-NM
1	Locate the sensor head within the rated sensing range with the E3X-N□.		
2	Set the mode selector to TEACH.	TEACH ↑ RUN	TEACH — TIMER — SET — RUN — ↑
3	The super-flashing function of the E3X-N□ will be activated. Therefore, adjust the optical axes so that the tip of the emitting fiber will be lit. If the optical axes are divergent, the tip of the emitting fiber will flash and the built-in buzzer of the E3X-N□ will beep.	---	

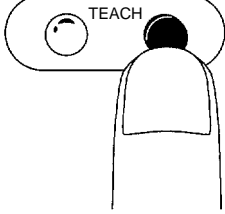
Procedure	Operation	E3X-NT	E3X-NM
4	<p>Press the teaching button for three seconds minimum with or without a sensing object. In the case of the E3X-NM, select a channel with the channel selector, at which time the stability indicator for the selected channel will flash.</p> <p>The teaching indicator (red) turns green.</p> <p>The built-in buzzer beeps once when the color of the teaching indicator is red.</p> <p>The built-in buzzer beeps continuously when the color of the teaching indicator is green.</p> <p>Note: The built-in buzzer will stop beeping when the teaching button is no longer being pressed.</p>		
5	<p>Set the mode setting selector to RUN to complete the sensitivity setting.</p> <p>The teaching indicator is OFF.</p> <p>Note: When the sensitivity is set to maximum, the sensitivity will be automatically adjusted regardless of the set distances of the fibers or light.</p>		
6	Select the logical output required with the operation mode selector.		

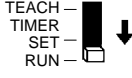
No-object Teaching

Procedure	Operation	E3X-NT	E3X-NM
1	Locate the sensor head within the rated sensing range with the E3X-N□.		
2	Set the mode selector to TEACH.		
3	The super-flashing function of the E3X-N□ will be activated. Therefore, adjust the optical axes so that the tip of the emitting fiber will be lit. If the optical axes are divergent, the tip of the emitting fiber will flash and the built-in buzzer of the E3X-N□ will beep.	---	
4	<p>Press the teaching button for 0.5 to 2.5 seconds without a sensing object. In the case the E3X-NM, select a channel with the channel selector and press the teaching button, at which time the stability indicator for the selected channel will flash.</p> <p>The teaching indicator (red) is lit.</p> <p>The built-in buzzer beeps once.</p>		
5	<p>Set the mode selector to RUN. No-object teaching will be set when the first sensing object passes through the sensing area.</p> <p>The teaching indicator (red) turns green (automatically turned off in one second).</p>		
6	Select the logical output required with the operation mode selector.		

- Note:**
- To detect dark objects in front of bright backgrounds, set the operation mode selector to D. ON.
 - If the set distance is very short (i.e., 0 to 12 mm for the E32-TC200 and 0 to 4 mm for the E32-DC200), no-object teaching is not possible due to excessive light, in which case, perform with/without-object teaching.
 - If the teaching button is pressed for more than three seconds, the sensitivity of the E3X-N□ will be set to maximum, at which time the green indicator will be lit.
 - The E3X-N□ will be ready to detect objects in approximately one second after the mode selector is set to RUN.

Remote Teaching/Timer Set Function

Remote Teaching Function

In principle, the remote teaching function of the E3X-N□ should be used for initial teaching. Basically, the method of remote teaching is the same as that of sensitivity setting. In remote teaching, instead of pressing the teaching button, teaching is performed with a remote teaching input signal.

1. Set the mode selector to RUN.
2. The following signal conditions must be given as remote teaching input conditions.

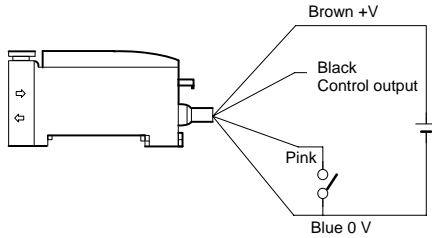

1. In the case of the E3X-NM, teaching is performed on all the four channels of the E3X-NM.
2. If all four channels are not used (e.g., only three channels are used), with/without-object teaching will not be available. In which case, perform the usual with/without-object teaching on the channels that are used instead of performing remote teaching.
3. If remote teaching is not performed, cut the pink wire at the base or connect the pink wire to the +V terminal.
4. After remote teaching input setting is finished, the E3X-N□ will be ready to detect objects in approximately one second.

Power supply		
Remote teaching input	With/Without-object teaching	
	Maximum sensitivity setting	
	No-object teaching	

Timer Set Function (E3X-NM)

1. Set the mode selector to TIMER SET.
2. Select a channel with the channel selector, at which time the stability indicator for the selected channel will flash.
3. The timer of the E3X-NM will be set by pressing the teaching button of the E3X-NM, at which time the operation indicator will be lit. When the teaching button is pressed again, the timer will be disabled and the operation indicator of the E3X-NM will be lit. To perform setting on other channels repeat procedures 2 and 3.
4. Set the mode selector to RUN.

Note: Channels are selected in the following order.

When all the channels are selected, it is possible to set the timer function on all channels.

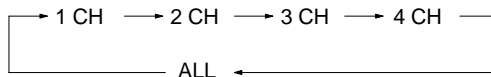

■ Optical Axis Adjustment (Super-flashing Function)

Set the mode selector of the E3X-N□ to TEACH. The super flashing function of E3X-N□ will be activated. When the optical axes of the fiber heads are divergent and the light value decreases by approximately 10% of the maximum value, the tip of the emitting fiber will start flashing and the built-in buzzer will beep. At this time, if the optical axes are divergent, adjust the axes. The peak light value will be memorized by the E3X-N□. Do not press the teaching button before or while adjusting the optical axes, otherwise, the super-flashing function will not operate.

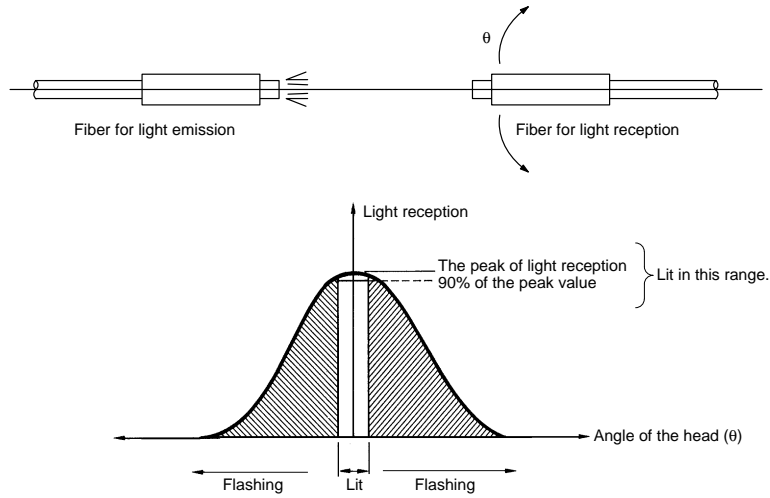

Dimensions

Note: All units are in millimeters unless otherwise indicated.

■ Flanges

E32-VF4

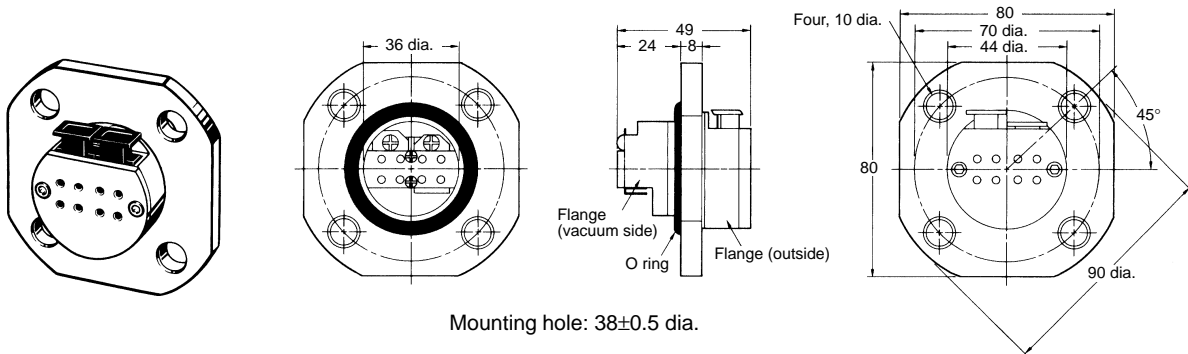

E32-VF1

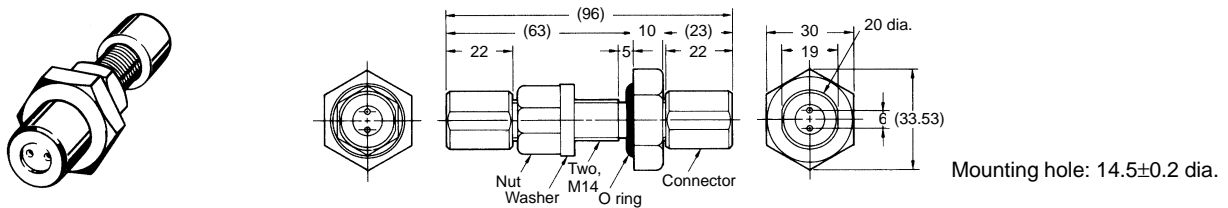

■ Vacuum Fibers

E32-T51V

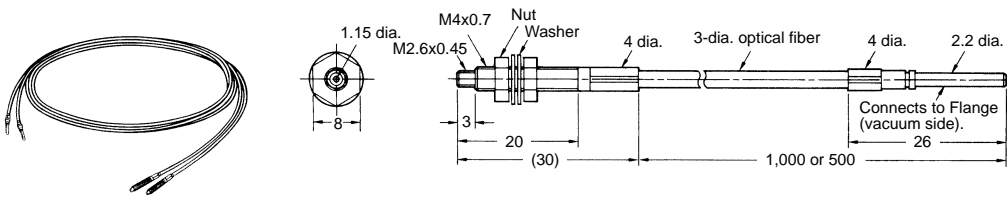

E32-T54V

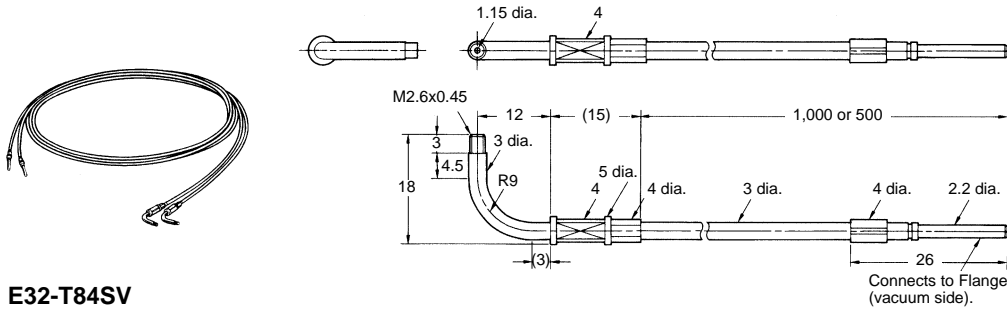

E39-L54V Mounting Bracket (Sold Separately)

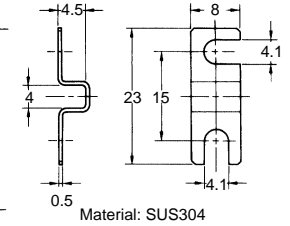

E32-T84SV

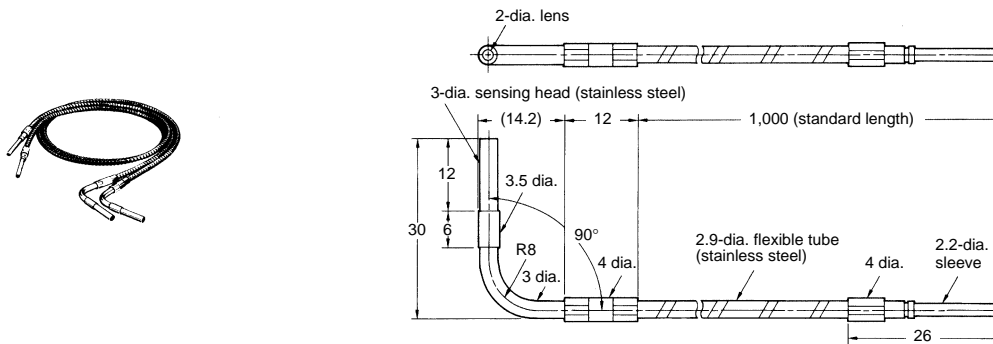

■ Fiber Unit for Outside

E32-T10V

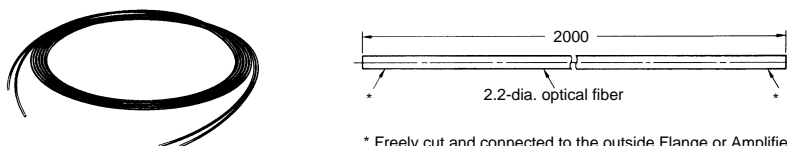

* Freely cut and connected to the outside Flange or Amplifier Unit.

■ Lens Unit (Sold Separately)

E32-F1V

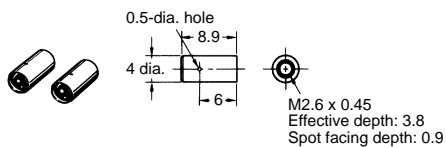

■ Amplifier Unit

E3X-NT11
E3X-NT21
E3X-NT41
E3X-NT51

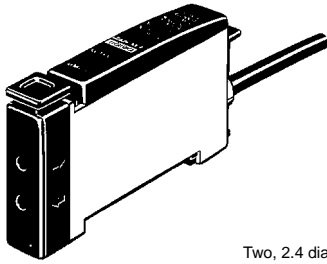

Cord: Polyvinyl chloride-covered cord
E3X-NT11: 4-mm dia. (40/0.12 dia.), 3 cores
E3X-NT21: 4-mm dia. (40/0.08 dia.), 4 cores
E3X-NT41: 4-mm dia. (40/0.12 dia.), 3 cores
E3X-NT51: 4-mm dia. (40/0.08 dia.), 4 cores
Standard length: 2 m

Weight: Approx. 100 g

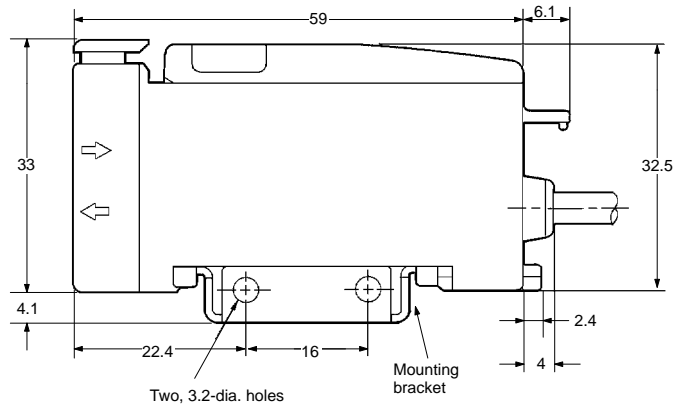
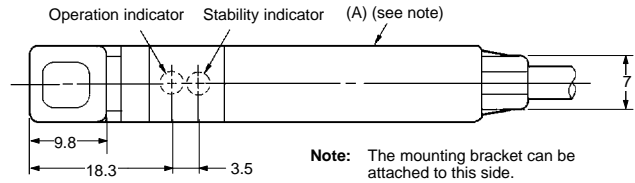
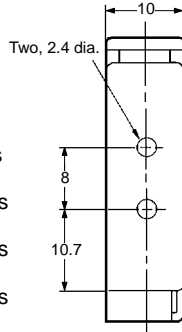

E3X-NM11
E3X-NM41

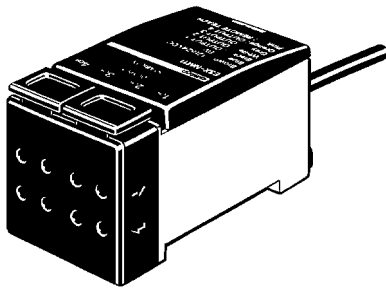

Cord: Polyvinyl chloride-covered cord
4-mm dia. (40/0.08 dia.), 7 cores
Standard length: 2 m

Weight: Approx. 200 g

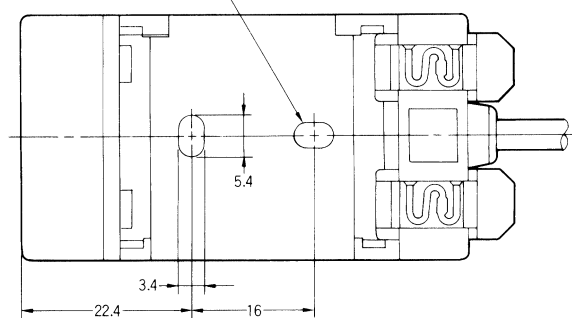
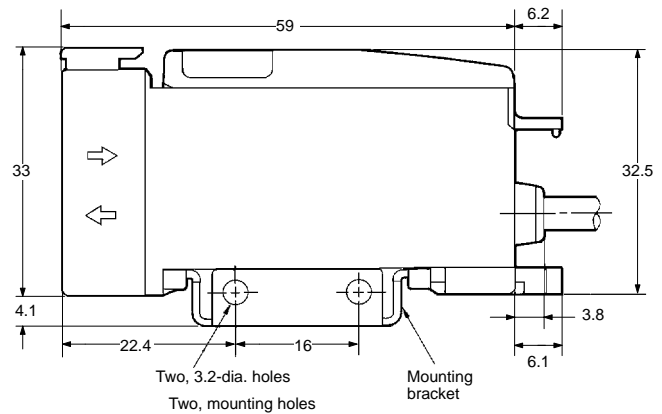
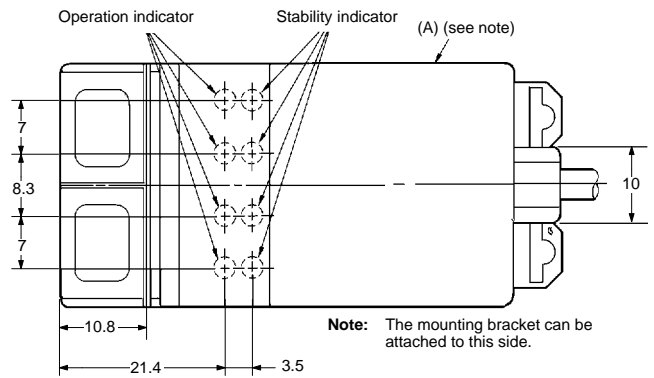
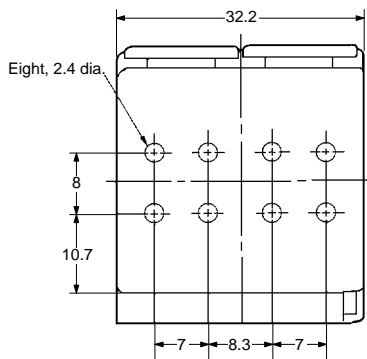

Precautions

Applications

The E32-V Vacuum Fiber Unit is used to detect a variety of objects located in high-vacuum chambers heated up to 120°C (some chambers operate at a maximum temperature of 200°C).

Cleaning

Although Flanges, Vacuum Fibers, and Lens Units are cleaned before shipping, clean them with alcohol before use in high-vacuum chambers to make sure there is no foreign matter on them.

Organic Solvents

Keep organic solvents away from the E32-V Vacuum Sensor.

Excessive Force

The E32-V Vacuum Fiber Unit resists a maximum force of 29.4 N (3 kgf). Do not impose extreme force, such as pulling force or pressure, on the E32-V Vacuum Sensor.

■ Amplifier Unit Precautions

Power Supply

Do not impose an excessive voltage on the E3X-NL, otherwise it may explode or burn. Do not impose 100 to 220 VAC on any E3X-NL DC model, otherwise it may explode or burn.

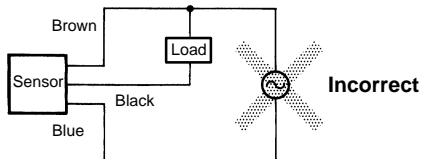

Load Short-circuit

Do not short-circuit the load connected to the E3X-NL, otherwise the E3X-NL may explode or burn.

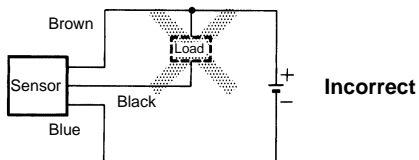

Wiring

Be sure to wire the E3X-NL and load correctly, otherwise it may explode or burn.

Ex. Wrong Polarity

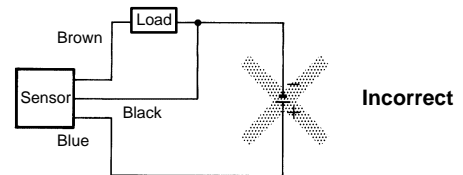

Ex. Wrong Wiring

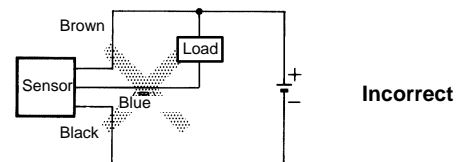

Connection with No Load

Make sure to connect a proper load to the E3X-NL in operation, otherwise it may explode or burn.

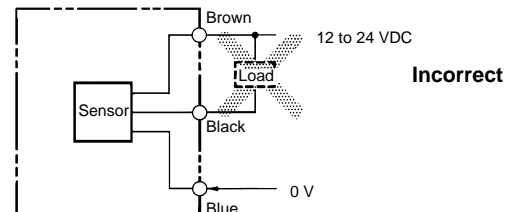

You must allow sufficient leeway in ratings and performance and provide proper fail-safe and other safety measures when using the E32-V in any of the following applications. Be sure also to consult with your OMRON representative before actually attempting any of these applications.

1. Applications under conditions or environments not specified in instruction manuals.
2. Applications for nuclear reactor control, train facilities, aviation facilities, motorized vehicles, furnaces, medical equipment, amusement equipment, and safety equipment.
3. Applications strongly related to human life or property, particularly those requiring safety.

ALL DIMENSIONS SHOWN ARE IN MILLIMETERS.

To convert millimeters into inches, multiply by 0.03937. To convert grams into ounces, multiply by 0.03527.

Cat. No. E252-E1-1 **In the interest of product improvement, specifications are subject to change without notice.**

OMRON Corporation

Systems Components Division H.Q.
28th Fl., Crystal Tower Bldg.
1-2-27, Shiromi, Chuo-ku,
Osaka 540 Japan
Phone: 06-949-6012 Fax: 06-949-6021

Printed in Japan
0996-1M (0996) a