

OMRON

Model

CPM1A-PRT21

PROFIBUS-DP SLAVE UNIT

INSTRUCTION SHEET

Thank you for purchasing an OMRON product. Read this instruction sheet thoroughly and familiarise yourself with the functions and characteristics of the product before using it. To ensure safe and correct use of this Unit, also read the following manual (Cat No. W353-E1-3 CPM-series Programming Manual).



Keep this instruction sheet for future reference.
OMRON MANUFACTURING OF THE NETHERLANDS B.V.
 © OMRON Corporation 2002 All Rights Reserved

⚠ DANGER Do not attempt to take the Unit apart and do not touch any internal parts while the power is being supplied. Doing either of these may result in electrical shock, and serious or fatal injury.

■ Nomenclature

Address switches, data format switch (Open top of cover)

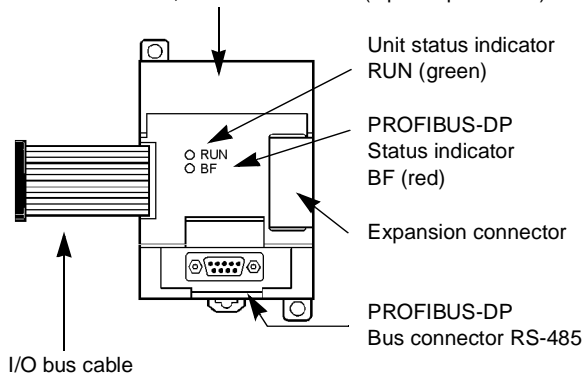

■ Unit Specifications

Storage temperature	-20 to +75 °C
Ambient temperature	0 to +55 °C
Ambient humidity	10 to 90 % (non-condensing)
EMC compliance	EN 50081-2, EN 61131-2
Current consumption	100 mA from the PLC I/O bus
Weight	125 g (typical)
Control data	From CPU to Unit : None
Status data	From Unit to CPU : None
I/O data (in bytes)	2 bytes input, 2 bytes output

■ Dimensions

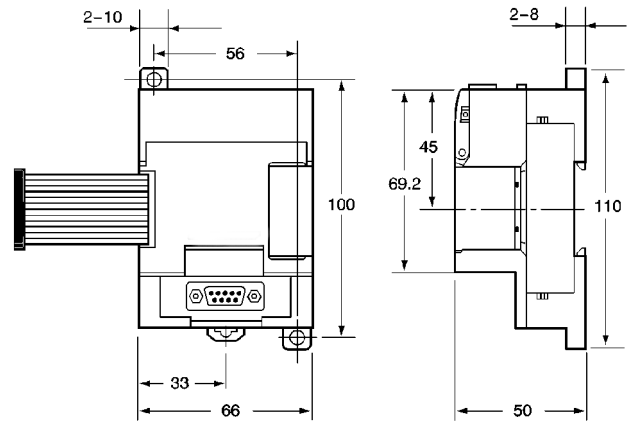

■ Notes on Mounting

The CPM1A-PRT21 can be mounted to the CPM1A/CPM2A PLC CPU Units, which allow for I/O expansion Units.

■ Data Mapping

The refreshing of the I/O data to the PLC is controlled by the PLC CPU. The location of the PROFIBUS I/O data in the PLC's memory is determined by the CPU's internal I/O points, and the physical location of the Unit in the chain of expansion Units, e.g. as shown.

CPU Unit (60 I/O points)	Temperature Sensor Unit CPM1A-TS002/102	PROFIBUS-DP Slave Unit CPM1A-PRT21
36 inputs IR 0000 to IR 00011 IR 00100 to IR 00111 IR 00200 to IR 00211	2 temperature inputs Input 0: IR 003 Input 1: IR 004 Input 2: IR 005 Input 3: IR 006	16 inputs IR 00700 to IR 00715
24 outputs IR 01000 to IR 01007 IR 01100 to IR 01107 IR 01200 to IR 01207	No outputs	16 outputs IR 01300 to IR 01315

Bits	15	14	13	12	11	10	09	08	07	06	05	04	03	02	01	00	
Inputs	IR000	Do not use			Used for CPU Unit input												
	IR 001	Do not use			Used for CPU Unit input												
	IR 002	Do not use			Used for CPU Unit input												
	IR 003	Used for input 0 of the Temperature Sensor Unit															
	IR 004	Used for input 0 of the Temperature Sensor Unit															
	IR 005	Used for input 1 of the Temperature Sensor Unit															
	IR 006	Used for input 1 of the Temperature Sensor Unit															
Outputs	IR 007	Used for 2 Bytes Input data CPM1A-PRT21 (PROFIBUS-DP output data)															
	IR 010																Used for CPU Unit output
	IR 011																Used for CPU Unit output
	IR 012																Used for CPU Unit output
	IR 013	Used for 2 Bytes Output data CPM1A-PRT21 (PROFIBUS-DP Input data)															

■ Indicators

Name	Colour	State	Unit status
RUN	green	OFF	Fatal error or no power supply. • Check the host PLC's CPU status. • Check the status of other I/O Units. • If all other Units function normally, replace the CPM1A-PRT21.
		ON	I/O Bus communication with the Unit is normal.

Name	Colour	State	Unit status
BF (Bus Fail)	Red	OFF	I/O data exchange on PROFIBUS-DP is active
		ON	No PROFIBUS-DP I/O data exchange, input to PLC is set to zero. • Response monitoring time has elapsed. The master did not address CPM1A-PRT21 within the configured watchdog time. • CPM1A-PRT21 was not parameterised or not properly configured. • Check the PROFIBUS cable.

PROFIBUS Address Switches

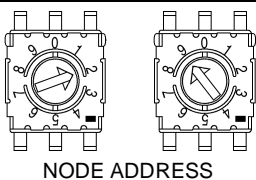
Switches	Function
	Sets the PROFIBUS slave address <ul style="list-style-type: none"> must be within the range 01-99, e.g. as shown: $2 \times 10 + 9 \times 1 = 29$ Out of range settings will disable all PROFIBUS communication (BF ON) Be sure to turn off the power to the Unit before changing the bus address.

I/O Data Format Switch:

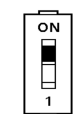
Switch	Function
	Provides compatibility with any 3 rd party PROFIBUS-DP master unit. OFF: Motorola (Big-endian) mode (Default) ON : Intel (Little-endian) mode

Motorola (Big-Endian)

By default, always use this setting when connecting to other OMRON PROFIBUS-DP Units.

The most significant byte of a PLC data word will be mapped to the first byte in the PROFIBUS-DP message, the least significant byte is mapped to the second byte, e.g.

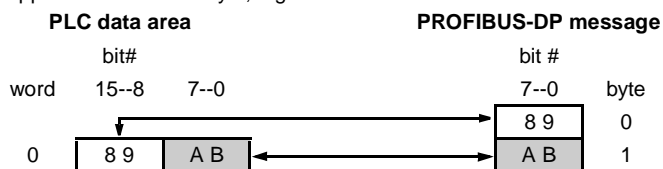

Intel (Little-Endian)

Alternatively, selecting Intel format will result in:

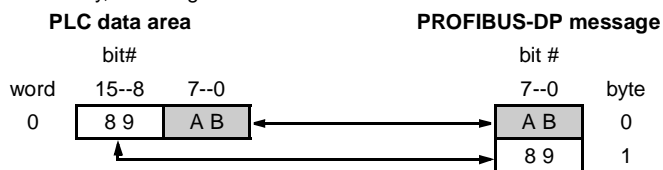

PROFIBUS-DP Connector

- The PROFIBUS-DP connector conforms to the guidelines defined in EN 50170 vol. 2.
- At baud rates over 1.5 Mbits/s, always use PROFIBUS-DP plugs with built-in inductors to minimise signal reflections.
- External termination as shown below is required if the Unit is the first or last station of a bus segment.

Pin	Signal	Description
1	Shield	Functional ground
2	-	
3	B-line	Data signal (RS-485)
4	RTS	Repeater control signal (TTL)
5	DGND	Data ground (0V)
6	VP	+5V for bus termination
7	-	
8	A-line	Data signal (RS-485)
9	-	
Case	Shield	Functional ground

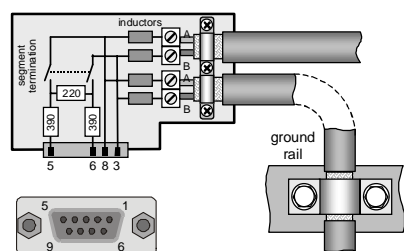

At least data lines A and B (pins 8 and 3) and the cable shield must be connected at each station.
Recommended colour coding:
A-line = pin 8 = GREEN,
B-line = pin 3 = RED

To ensure electromagnetic compatibility, clamp the cable shield to a grounding rail in the control cabinet, as close as possible to the cable lead-through

PROFIBUS Cable

Only use shielded twisted pair cable, line type A as specified by EN 50170 vol.2, with the following specifications (e.g. Belden 3079A):

Parameter	Value
Impedance	135 to 165 Ω
Capacitance per unit length	< 30 pF/m
Loop resistance	< 110 Ω/km
Core diameter	> 0.64 mm
Core cross section	> 0.34 mm ²

The maximum cable length per bus segment (32 stations) depends on the selected communication speed:

Baud rate (kbit/s)	Length/segment (m)
9.6, 19.2, 45.45, 93.75	1200
187.5	1000
500	400
1500	200
3000, 6000, 12000	100

Communication Specifications

Applicable standard	EN 50170 vol. 2 (PROFIBUS-DP)
Type	PROFIBUS-DP SLAVE
Bus connector	9-pin sub-D female, RS-485
Bus termination	Not included
Baud rates in kbit/s (auto-detect)	9.6, 19.2, 45.45, 93.75, 187.5, 500, 1500, 3000, 6000, 12000
PROFIBUS address range	01-99
Communication cable	Type A (EN 50170 vol. 2)
Minimum slave interval	0.5 ms
Input data	2 bytes, no consistency
Output data	2 bytes, no consistency
Supported DP functions (as responder)	Data_Exchange Chk_Cfg Set_Prm Slave_Diag Global_Control (SYNC/FREEZE/CLEAR) RD_Inp RD_Outp Get_Cfg
GSD file	OC_0658.GSD

Quick Start

- Configure the PROFIBUS-DP master to communicate with the CPM1A-PRT21, using the provided GSD file.
- Set the NODE ADDRESS as configured in the master.
- Mount the Unit and connect the PROFIBUS cable.
- Set termination if it is the last station on a bus segment.
- Turn PLC power ON.
- Check that RUN LED is ON, BF LED is OFF.

OMRON

OMRON CORPORATION

OMRON EUROPE B.V.

Wegalaan 67-69, NL-2132 JD, Hoofddorp, The Netherlands
Phone (+31) 23 - 56 81 300, Fax (+31) 23 - 56 81 388

Note: Specification subject to change without notice
Printed in The Netherlands

1628862-9A